

1-521766-2 ✓ ACTIVE

Positive Lock | Mark III, Positive Lock 250

TE Internal #: 1-521766-2

Crimp Terminal Housings, Receptacle, Receptacle, 2 Position, Straight, UL 94V-0, Natural, Nylon, Contact Mating Retention, Positive Lock 250

[View on TE.com >](#)



Terminals & Splices > Terminal Housings, Insulation Sleeves & Blocks > Crimp Terminal Housings

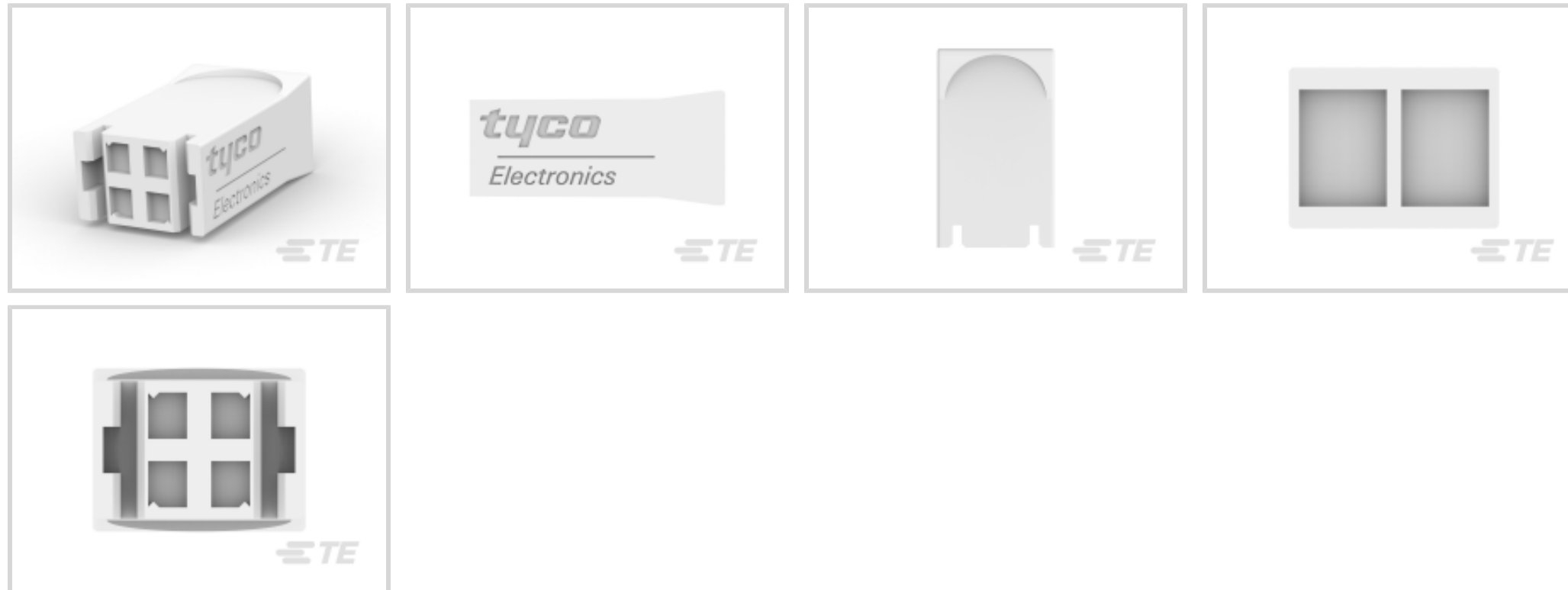

Terminal Type: **Receptacle**

Connector & Housing Type: **Receptacle**

Number of Positions: **2**

Terminal Orientation: **Straight**

UL Flammability Rating: **UL 94V-0**

Features

Product Type Features

Sealable	No
Connector System	Wire-to-Board, Wire-to-Wire
Connector & Housing Type	Receptacle

Configuration Features

Number of Positions	2
---------------------	---

Body Features

Primary Product Color	Natural
-----------------------	---------

Contact Features

Terminal Type	Receptacle
Terminal Orientation	Straight
Contact Mating Retention	With

Mechanical Attachment

Mating Alignment Type	Polarization
-----------------------	--------------



Mating Alignment	With
Connector Mounting Type	Cable Mount (Free-Hanging)

Housing Features

Housing Material	Nylon
Centerline (Pitch)	10.8 mm [.425 in]

Usage Conditions

Operating Temperature Range	-40 – 130 °C [-40 – 266 °F]
-----------------------------	-----------------------------

Industry Standards

Glow Wire Rating	GWT 750°C (Without Flame)
UL Flammability Rating	UL 94V-0

Packaging Features

Packaging Quantity	1
Packaging Method	Carton

Product Compliance

[For compliance documentation, visit the product page on TE.com>](#)

EU RoHS Directive 2011/65/EU	Compliant
EU ELV Directive 2000/53/EC	Compliant
China RoHS 2 Directive MIIT Order No 32, 2016	No Restricted Materials Above Threshold
EU REACH Regulation (EC) No. 1907/2006	Current ECHA Candidate List: JUNE 2023 (235) Candidate List Declared Against: JUNE 2023 (235) Does not contain REACH SVHC
Halogen Content	Not Low Halogen - contains Br or Cl > 900 ppm.
Solder Process Capability	Not reviewed for solder process capability

Product Compliance Disclaimer

This information is provided based on reasonable inquiry of our suppliers and represents our current actual knowledge based on the information they provided. This information is subject to change. The part numbers that TE has identified as EU RoHS compliant have a maximum concentration of 0.1% by weight in homogenous materials for lead, hexavalent chromium, mercury, PBB, PBDE, DBP, BBP, DEHP, DIBP, and 0.01% for cadmium, or qualify for an exemption to these limits as defined in the Annexes of Directive 2011/65/EU (RoHS2). Finished electrical and electronic equipment products will be CE marked as required by Directive 2011/65/EU. Components may not be CE marked. Additionally, the part numbers that TE has identified as EU ELV compliant have a maximum concentration of 0.1% by weight in homogenous materials for lead, hexavalent chromium, and mercury, and 0.01% for cadmium, or qualify for an exemption to these limits as defined in the Annexes of Directive 2000/53/EC (ELV). Regarding the REACH Regulation, the information TE provides

on SVHC in articles for this part number is based on the latest European Chemicals Agency (ECHA) 'Guidance on requirements for substances in articles' posted at this URL: <https://echa.europa.eu/guidance-documents/guidance-on-reach>

Compatible Parts



TE Part # 63933-2
250 PL MKIII REC. 22-18AWG TPBR



TE Part # 63854-1
250 PL MKIII REC. 18-14AWG BR



TE Part # 63854-2
250 PL MKIII REC. 18-14AWG TPBR



TE Part # 63933-1
PL .250 TERMINAL REC 22-18 AWG BR



TE Part # 1217092-1
PL 250 TERMINAL RECEPTACLE 16-12 AWG BR



TE Part # 1217092-2
PL 250 TERMINAL REC 16-12 AWG TPBR

Also in the Series | Mark III



Crimp Terminal Housings(30)



Quick Disconnects(15)

Also in the Series | Positive Lock 250



Automotive Terminals(1)



Crimp Terminal Housings(193)



Insertion & Extraction Tools(3)



Insulation Boots & Sleeves(4)



Quick Disconnects(186)

Customers Also Bought



TE Part #61794-1
RING 18-14 AWG TPST



TE Part #180437-2
110 FASTON,REC.,20-16 AWG,PTBR



TE Part #3-2213766-5
AV19 SPL 5A POWER LED GREEN 24V

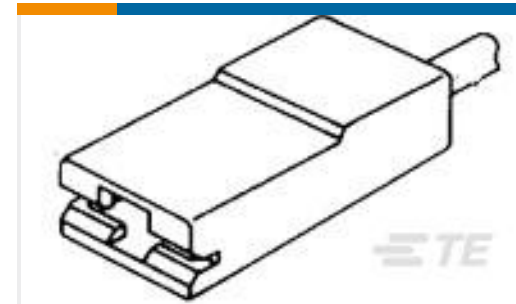

TE Part #735052
110 FASTON SLEEVE REC. 1P
NATURAL

Documents

Product Drawings

[PL MKIII 250 REC HSG 2P](#)

English

CAD Files

[3D PDF](#)

3D

Customer View Model

[ENG_CVM_CVM_1-521766-2_D.2d_dxf.zip](#)

English

Customer View Model

[ENG_CVM_CVM_1-521766-2_D.3d_igs.zip](#)

English

Customer View Model

[ENG_CVM_CVM_1-521766-2_D.3d_stp.zip](#)

English

By downloading the CAD file I accept and agree to the [Terms and Conditions](#) of use.

Product Environmental Compliance

[MD_1-521766-2_021820192222_dmtec](#)

English

[MD_1-521766-2_021820192222_dmtec](#)

English