

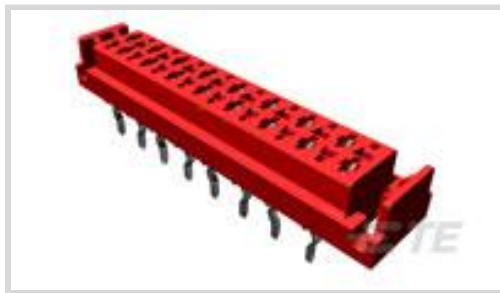

Connectors > PCB Connectors > Wire-to-Board Connectors > FFC, FPC & Ribbon Connectors > Ribbon Cable Connectors >

Female-on-Board Connector, Top Entry



Connector System: **Board-to-Board**

Number of Positions: **18**

Centerline (Pitch): **1.27 mm [.05 in]**

PCB Mount Retention: **With**

PCB Mount Retention Type: **Kinked Solder Tails**

[All Female-on-Board Connector, Top Entry \(67\)](#)

Features

Product Type Features

Ribbon Cable Connector Type	Female-on-Board
Ribbon Cable Connector Header Type	Shrouded
Connector Product Type	Connector Assembly
Connector System	Board-to-Board
Connector & Housing Type	Receptacle
Connector & Contact Terminates To	Printed Circuit Board

Configuration Features

Number of Positions	18
PCB Mount Orientation	Vertical
Number of Rows	2

Electrical Characteristics

Insulation Resistance	1000 MΩ
Operating Voltage	100 VAC

Body Features

Daisy Chain	Without
Primary Product Color	Red



Connector Profile	Standard
-------------------	----------

Contact Features

PCB Contact Termination Area Plating Material Thickness	3 – 5 μm [118.11 – 196.85 μin]
Contact Type	Socket
Contact Mating Area Plating Material Thickness	3 – 5 μm [118.11 – 196.85 μin]
Contact Mating Area Plating Material	Tin
PCB Contact Termination Area Plating Material Finish	Matte
Contact Shape & Form	Dual Beam
Contact Underplating Material	Nickel
PCB Contact Termination Area Plating Material	Tin
Contact Base Material	Phosphor Bronze
Contact Current Rating (Max)	1 A

Termination Features

Rectangular Termination Post & Tail Thickness	.25 mm[.01 in]
Rectangular Termination Post & Tail Width	.5 mm[.02 in]
Termination Post & Tail Length	3.1 mm[.122 in]
Termination Method to Printed Circuit Board	Through Hole - Solder

Mechanical Attachment

Mating Alignment	With
Contact Retention Type Within Housing	Press-Fit
PCB Mount Alignment	Without
PCB Mount Retention	With
PCB Mount Retention Type	Kinked Solder Tails
Mating Alignment Type	Polarization
Mating Retention	With
Mating Retention Type	Contact Friction
Connector Mounting Type	Board Mount

Housing Features

Mating Entry Location	Top
Housing Material	PBT GF
Centerline (Pitch)	1.27 mm[.05 in]

Dimensions

--	--



Connector Length	27.4 mm[1.07 in]
Connector Height	4 mm[.16 in]
PCB Thickness (Recommended)	1.6 mm[.062 in]
Row-to-Row Spacing	2 mm[.059 in]

Usage Conditions

Operating Temperature Range	-40 – 105 °C[-40 – 221 °F]
-----------------------------	----------------------------

Operation/Application

Solder Process Feature	Board Standoff
Circuit Application	Signal

Industry Standards

UL Rating	Recognized
Agency/Standard	UL
Approved Standards	UL E28476
UL Flammability Rating	UL 94V-0

Packaging Features

Packaging Quantity	2500
Packaging Method	Reel

Product Compliance

[For compliance documentation, visit the product page on TE.com>](#)

EU RoHS Directive 2011/65/EU	Compliant
EU ELV Directive 2000/53/EC	Compliant
China RoHS 2 Directive MIIT Order No 32, 2016	No Restricted Materials Above Threshold
EU REACH Regulation (EC) No. 1907/2006	Current ECHA Candidate List: JUNE 2023 (235) Candidate List Declared Against: JUNE 2023 (235) Does not contain REACH SVHC
Halogen Content	Not Low Halogen - contains Br or Cl > 900 ppm.
Solder Process Capability	Wave solder capable to 265°C

Product Compliance Disclaimer

This information is provided based on reasonable inquiry of our suppliers and represents our current actual knowledge based on the information they provided. This information is subject to change. The part numbers that TE has identified as EU RoHS compliant have a maximum concentration of 0.1% by weight in homogenous materials for lead, hexavalent

chromium, mercury, PBB, PBDE, DBP, BBP, DEHP, DIBP, and 0.01% for cadmium, or qualify for an exemption to these limits as defined in the Annexes of Directive 2011/65/EU (RoHS2). Finished electrical and electronic equipment products will be CE marked as required by Directive 2011/65/EU. Components may not be CE marked. Additionally, the part numbers that TE has identified as EU ELV compliant have a maximum concentration of 0.1% by weight in homogenous materials for lead, hexavalent chromium, and mercury, and 0.01% for cadmium, or qualify for an exemption to these limits as defined in the Annexes of Directive 2000/53/EC (ELV). Regarding the REACH Regulation, the information TE provides on SVHC in articles for this part number is based on the latest European Chemicals Agency (ECHA) 'Guidance on requirements for substances in articles' posted at this URL: <https://echa.europa.eu/guidance-documents/guidance-on-reach>

Compatible Parts



TE Part # CAT-M5833-M2934A
Male-on-Wire Connector, Micro-MaTch



TE Part # CAT-M5833-M2934
Male-on-Board Connector, Micro-MaTch



TE Part # 1-338095-8
18P. MICRO-MATCH COSI HSG

Also in the Series | Micro-MaTch Industrial



Board-In Connectors(20)



Insertion & Extraction Tools(1)



PCB Headers & Receptacles(1)



Pluggable I/O Cable Assemblies(52)



Ribbon Cable Connectors(185)



Wire-to-Board Connector Contacts(4)

Customers Also Bought

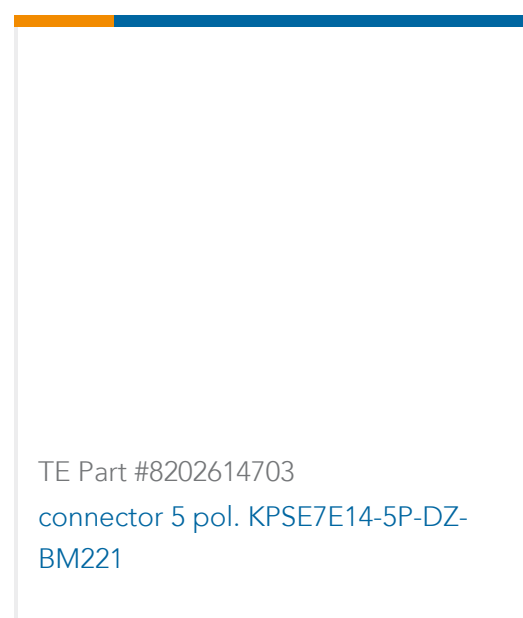
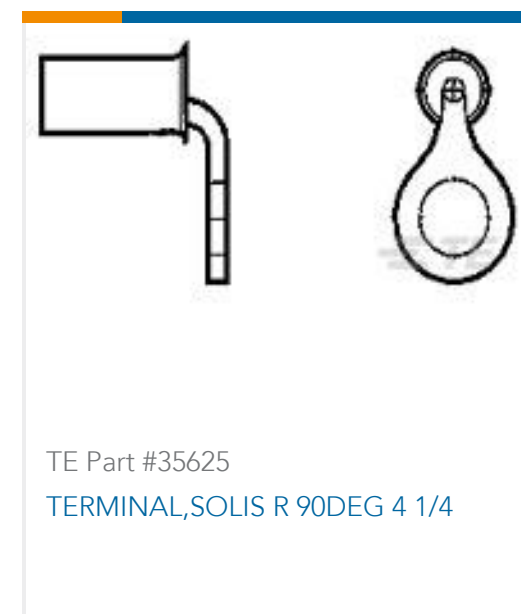

Documents

Product Drawings

[MICRO-MATCH FTE,18P](#)

English

CAD Files

[3D PDF](#)

3D

Customer View Model

[ENG_CVM_CVM_1-338068-8_F.2d_dxf.zip](#)

English

Customer View Model

[ENG_CVM_CVM_1-338068-8_F.3d_igs.zip](#)

English

Customer View Model

[ENG_CVM_CVM_1-338068-8_F.3d_stp.zip](#)

English

By downloading the CAD file I accept and agree to the [Terms and Conditions](#) of use.

Datasheets & Catalog Pages



[Micro-MaTch Catalog](#)

English

[Centerline Micro-Match Connector Series](#)

English

[Product Specifications](#)

[Product Specification](#)

English