

1-293041-1 ✓ ACTIVE

FASTIN-FASTON | FASTIN-FASTON 250

TE Internal #: 1-293041-1

Quick Disconnects, Tab, 20 – 17 AWG Wire Size, .51 – 1.03 mm<sup>2</sup>

Wire Size, Mating Tab Width 6.35 mm [.25 in], Straight, Brass,

FASTIN-FASTON 250

[View on TE.com >](#)



Terminals & Splices > Quick Disconnects

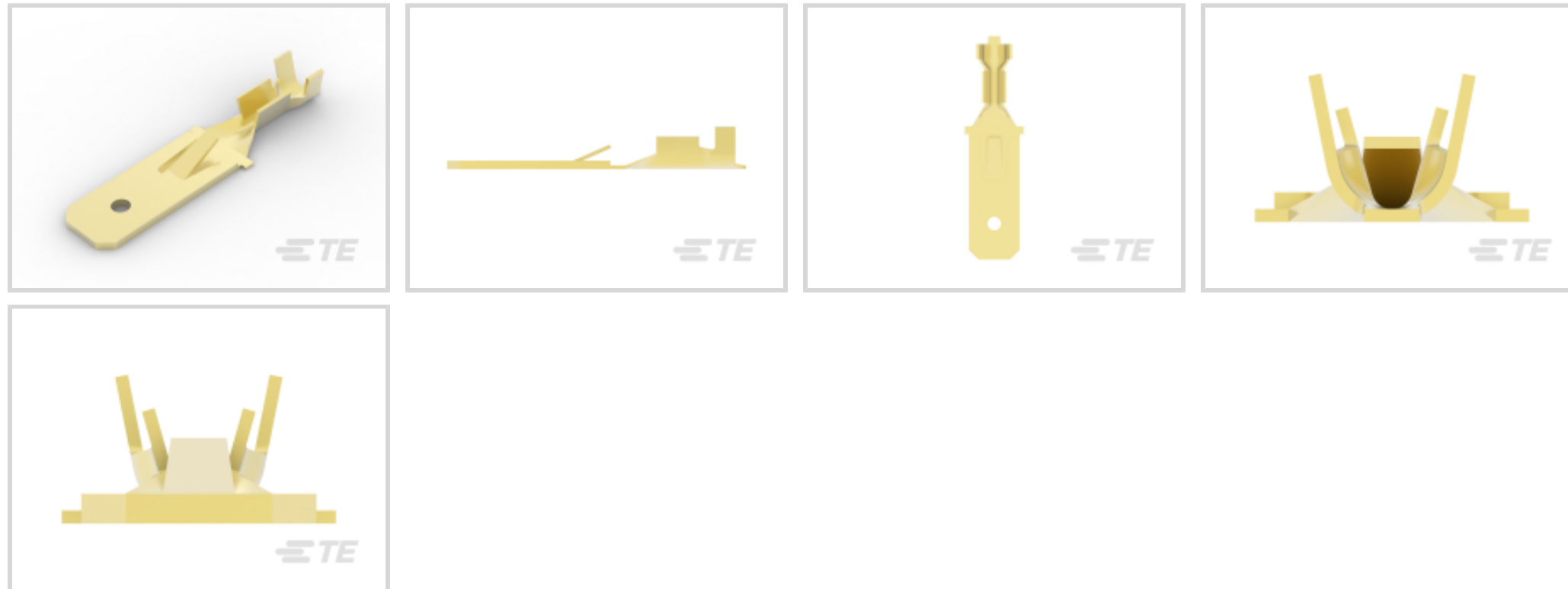

Quick Disconnect Terminal Type: **Tab**

Wire Size: **.51 – 1.03 mm<sup>2</sup>**

Mating Tab Width: **6.35 mm [.25 in]**

Mating Tab Thickness: **.81 mm [.032 in]**

## Features

### Product Type Features

Insertion Force	Normal
-----------------	--------

### Configuration Features

Connection Capacity	Single
Compatible With Wire & Cable Type	Discrete Wire

### Contact Features

Quick Disconnect Terminal Type	Tab
Mating Tab Width	6.35 mm [.25 in]
Mating Tab Thickness	.81 mm [.032 in]
Terminal Orientation	Straight
Contact Base Material	Brass
Terminal Plating Material	Unplated
Crimp Type	F-Crimp
Barrel Type	Open

### Termination Features

--	--



Product Terminates To	Wire & Cable
-----------------------	--------------

### Mechanical Attachment

Locking Lance Height	1.5 mm[.06 in]
----------------------	----------------

Wire Insulation Support	With
-------------------------	------

Mating Retention Type	Dimple
-----------------------	--------

### Dimensions

Terminal Material Thickness	.36 mm[.014 in]
-----------------------------	-----------------

Product Length	27 mm[1.063 in]
----------------	-----------------

Compatible Insulation Diameter Range	2.31 mm[.091 in]
--------------------------------------	------------------

Wire Size	.51 – 1.03 mm <sup>2</sup>
-----------	----------------------------

### Usage Conditions

Insulation Option	Uninsulated
-------------------	-------------

Operating Temperature Range	-40 – 110 °C[-40 – 230 °F]
-----------------------------	----------------------------

### Packaging Features

Packaging Quantity	3000
--------------------	------

Packaging Method	Strip/Reel
------------------	------------

### Product Compliance

[For compliance documentation, visit the product page on TE.com>](#)

EU RoHS Directive 2011/65/EU	Compliant
------------------------------	-----------

EU ELV Directive 2000/53/EC	Compliant
-----------------------------	-----------

China RoHS 2 Directive MIIT Order No 32, 2016	No Restricted Materials Above Threshold
---	---

EU REACH Regulation (EC) No. 1907/2006	Current ECHA Candidate List: JUNE 2023 (235) Candidate List Declared Against: JUNE 2023 (235) Does not contain REACH SVHC
--	---

Halogen Content	Low Halogen - Br, Cl, F, I < 900 ppm per homogenous material. Also BFR/CFR/PVC Free
-----------------	---

Solder Process Capability	Not applicable for solder process capability
---------------------------	--

#### Product Compliance Disclaimer

This information is provided based on reasonable inquiry of our suppliers and represents our current actual knowledge based on the information they provided. This information is subject to change. The part numbers that TE has identified as EU RoHS compliant have a maximum concentration of 0.1% by weight in homogenous materials for lead, hexavalent chromium, mercury, PBB, PBDE, DBP, BBP, DEHP, DIBP, and 0.01% for cadmium, or qualify for an exemption to these

limits as defined in the Annexes of Directive 2011/65/EU (RoHS2). Finished electrical and electronic equipment products will be CE marked as required by Directive 2011/65/EU. Components may not be CE marked. Additionally, the part numbers that TE has identified as EU ELV compliant have a maximum concentration of 0.1% by weight in homogenous materials for lead, hexavalent chromium, and mercury, and 0.01% for cadmium, or qualify for an exemption to these limits as defined in the Annexes of Directive 2000/53/EC (ELV). Regarding the REACH Regulation, the information TE provides on SVHC in articles for this part number is based on the latest European Chemicals Agency (ECHA) 'Guidance on requirements for substances in articles' posted at this URL: <https://echa.europa.eu/guidance-documents/guidance-on-reach>

## Compatible Parts



TE Part # 2150035-2  
 OCEAN\_2.0\_Applicator-E-080F130F



TE Part # 284672-1  
 FF 250 TAB PTBR



TE Part # 7-2150035-2  
 OCEAN\_2.0\_Applicator-E-080F130F



TE Part # 7-2150035-7  
 OCEAN\_2.0\_SPARE\_PART\_KIT-080F130F



TE Part # 880688-2  
 FF 250 TERMINAL 0.5-1.0MM2 0.39 X13.2TPBR



TE Part # 2-2150035-2  
 OCEAN\_2.0\_Applicator-E-080F130F



TE Part # 1-1241857-5  
 5POS. FASTIN-FASTON\* TAB HSG, RAST5

## Also in the Series | FASTIN-FASTON 250

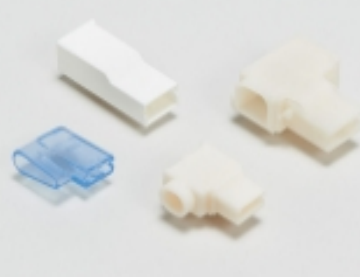

Crimp Terminal Housings(211)



Insertion & Extraction Tools(2)



PCB Terminals(2)



Quick Disconnects(254)

## Customers Also Bought

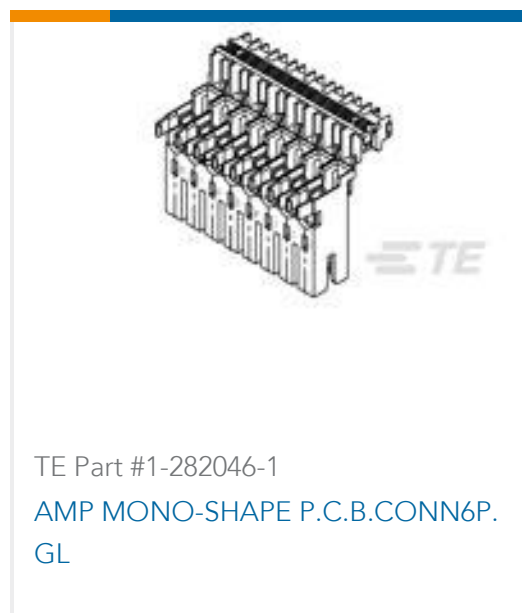
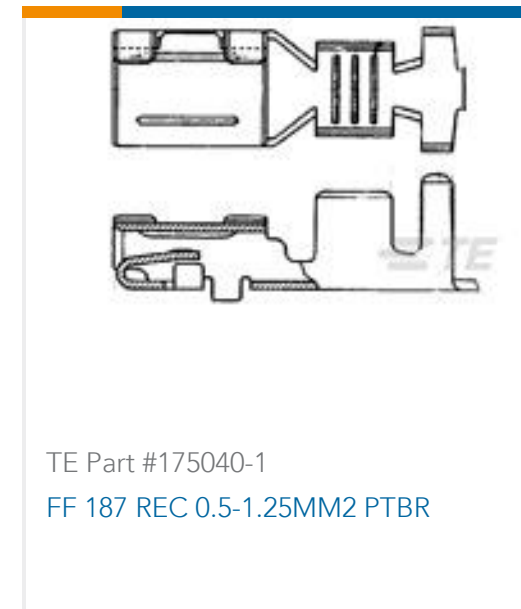

## Documents

### Product Drawings

[FF 250 PLUG 0.35-1MM2 BR](#)

English

### CAD Files

[3D PDF](#)

3D

### Customer View Model

[ENG\\_CVM\\_CVM\\_1-293041-1\\_C\\_c-1-293041-1-c.2d\\_dxf.zip](#)

English

### Customer View Model

[ENG\\_CVM\\_CVM\\_1-293041-1\\_C\\_c-1-293041-1-c.3d\\_igs.zip](#)

English

### Customer View Model

[ENG\\_CVM\\_CVM\\_1-293041-1\\_C\\_c-1-293041-1-c.3d\\_stp.zip](#)

English

By downloading the CAD file I accept and agree to the [Terms and Conditions](#) of use.

## Product Specifications



## FASTIN-FASTON\* Connectors, 6.3 mm series TAB CONTACT.

### Application Specification

---

### Product Environmental Compliance

#### TE Material Declaration

English