

1-284094-1 ✓ ACTIVE

Buchanan

TE Internal #: 1-284094-1

PCB Terminal Blocks, Header, Wire-to-Board, 11 Position, .2 in [5.08 mm] Centerline, 1 Row, 90° Wire Entry Angle, 30 – 16 AWG Wire Size

[View on TE.com >](#)



Connectors > Terminal Blocks & Strips > PCB Terminal Blocks

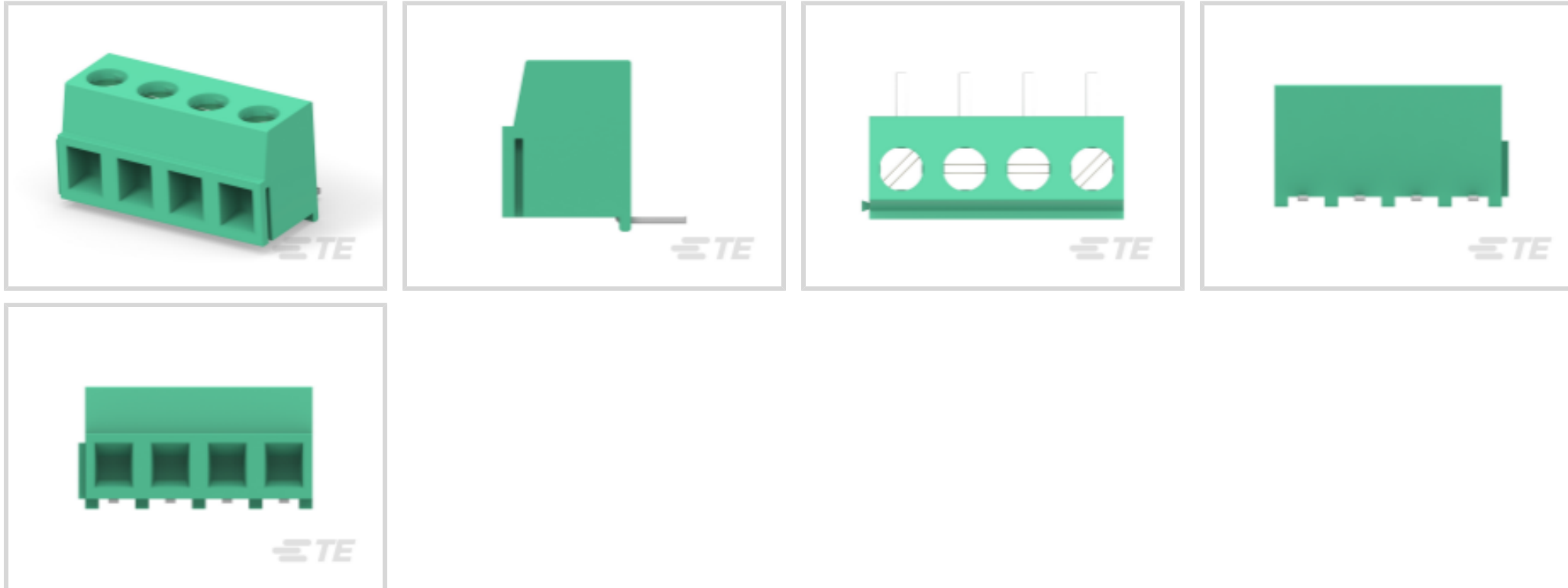

Terminal Block Connector Type: **Header**

Connector System: **Wire-to-Board**

Number of Positions: **11**

Centerline (Pitch): **5.08 mm [.2 in]**

Number of Rows: **1**

Features

Product Type Features

Wire Protection	With
Terminal Block Connector Type	Header
Connector System	Wire-to-Board
Connector & Contact Terminates To	Printed Circuit Board

Configuration Features

Stacked Levels	Without
Wire Entry Location	Top
Stacking Configuration	Side Stackable
Number of Positions	11
Number of Rows	1
Wire Entry Angle	90°

Electrical Characteristics

Operating Voltage	300 VAC
-------------------	---------

Body Features



Primary Product Color	Green
-----------------------	-------

Product Orientation	Right Angle
---------------------	-------------

Contact Features

Contact Mating Area Plating Material	Tin
--------------------------------------	-----

Contact Base Material	Brass
-----------------------	-------

Contact Current Rating (Max)	13.5 A
------------------------------	--------

Termination Features

Termination Post & Tail Length	3.5 mm[.138 in]
--------------------------------	-----------------

Termination Method to Printed Circuit Board	Through Hole - Solder
---	-----------------------

Mechanical Attachment

Screw Plating Material	Nickel
------------------------	--------

Screw Material	Brass
----------------	-------

Thread Size	M3
-------------	----

Connector Mounting Type	Board Mount
-------------------------	-------------

Housing Features

Housing Material	PA 66
------------------	-------

Centerline (Pitch)	5.08 mm[.2 in]
--------------------	----------------

Dimensions

Wire Size	.05 – 1.31 mm ²
-----------	----------------------------

Usage Conditions

Operating Temperature Range	-40 – 110 °C[-40 – 230 °F]
-----------------------------	----------------------------

Operation/Application

Circuit Application	Power & Signal
---------------------	----------------

Packaging Features

Packaging Quantity	100
--------------------	-----

Packaging Method	Box
------------------	-----

Other

Terminal Blocks & Strips Comment	10A Field Wiring
----------------------------------	------------------

Product Compliance

[For compliance documentation, visit the product page on TE.com>](#)



EU RoHS Directive 2011/65/EU	Compliant with Exemptions
EU ELV Directive 2000/53/EC	Compliant with Exemptions
China RoHS 2 Directive MIIT Order No 32, 2016	Restricted Materials Above Threshold
EU REACH Regulation (EC) No. 1907/2006	<p>Current ECHA Candidate List: JUNE 2023 (235)</p> <p>Candidate List Declared Against: JUNE 2023 (235)</p> <p>SVHC > Threshold:</p> <p>Pb (.8% in Component Part)</p> <p>Article Safe Usage Statements: Do not eat, drink or smoke when using this product. Wash thoroughly after handling. Recycle if possible and dispose of the article by following all applicable governmental regulations relevant to your geographic location.</p>
Halogen Content	Low Halogen - Br, Cl, F, I < 900 ppm per homogenous material. Also BFR/CFR/PVC Free
Solder Process Capability	Wave solder capable to 265°C

Product Compliance Disclaimer

This information is provided based on reasonable inquiry of our suppliers and represents our current actual knowledge based on the information they provided. This information is subject to change. The part numbers that TE has identified as EU RoHS compliant have a maximum concentration of 0.1% by weight in homogenous materials for lead, hexavalent chromium, mercury, PBB, PBDE, DBP, BBP, DEHP, DIBP, and 0.01% for cadmium, or qualify for an exemption to these limits as defined in the Annexes of Directive 2011/65/EU (RoHS2). Finished electrical and electronic equipment products will be CE marked as required by Directive 2011/65/EU. Components may not be CE marked. Additionally, the part numbers that TE has identified as EU ELV compliant have a maximum concentration of 0.1% by weight in homogenous materials for lead, hexavalent chromium, and mercury, and 0.01% for cadmium, or qualify for an exemption to these limits as defined in the Annexes of Directive 2000/53/EC (ELV). Regarding the REACH Regulation, the information TE provides on SVHC in articles for this part number is based on the latest European Chemicals Agency (ECHA) 'Guidance on requirements for substances in articles' posted at this URL: <https://echa.europa.eu/guidance-documents/guidance-on-reach>

Compatible Parts

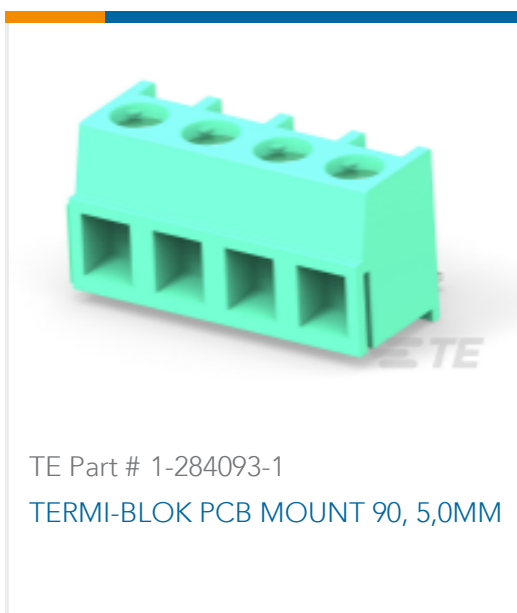

Customers Also Bought



TE Part #2-5177986-6
0.8FH,P07H.5,140,08/Sn,TR,SC

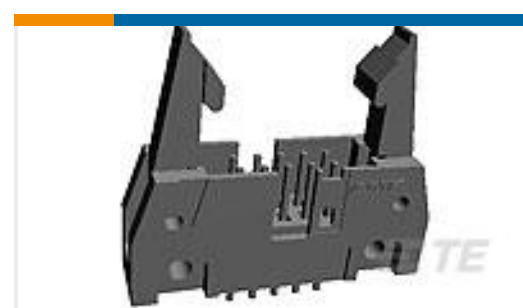

TE Part #5499910-3
A/L UNIV HDR 16P VERT SHT LAT



TE Part #1-1415899-0
RZ01-1C4-D012

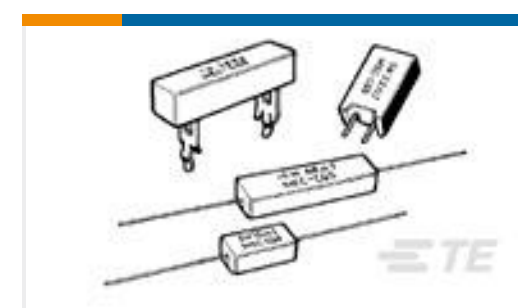

TE Part #1623782-8
SQM5 2K2 5% (METAL FILM)

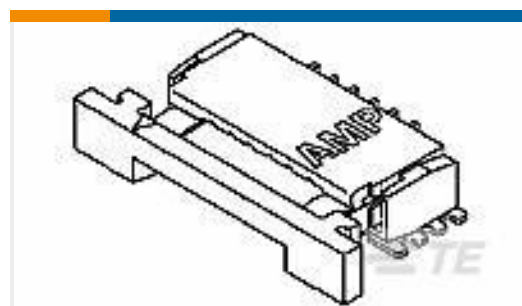

TE Part #84952-4
1MM FPC HORZ.BTTM CONT.ASS.4P



TE Part #1-1393194-0
T77S1D10-24



TE Part #2-1393194-1
T77V1D10-24

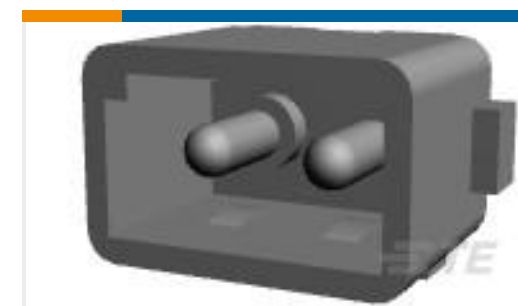

TE Part #350422-1
02P CMNL HDR ASSY PC NATL

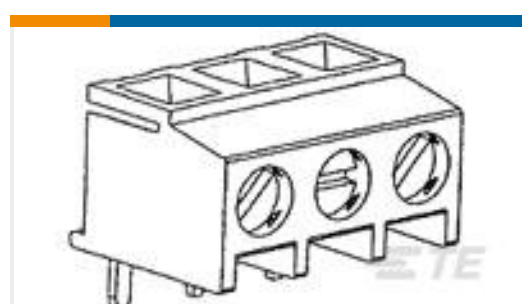

TE Part #284094-5
TERMI-BLOK PCB MOUNT 90, 5,08M

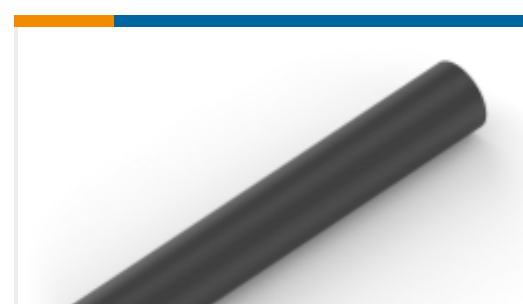

TE Part #NB10802001
ATUM-32/8-0-STK

Documents

Product Drawings

[TERMI-BLOK PCB MOUNT 90, 5,08M](#)

English

CAD Files

[3D PDF](#)

3D

Customer View Model

[ENG_CVM_CVM_1-284094-1_E.2d_dxf.zip](#)

English

Customer View Model

[ENG_CVM_CVM_1-284094-1_E.3d_igs.zip](#)

English

Customer View Model

[ENG_CVM_CVM_1-284094-1_E.3d_stp.zip](#)

English

By downloading the CAD file I accept and agree to the [Terms and Conditions](#) of use.

Datasheets & Catalog Pages



BUCHANAN TERMINAL BLOCKS CATALOG - EUROSTYLE TERMINAL BLOCKS

English

[1-1773458-1_EURO_STYLE_TERMINAL_BLOCKS_QRG](#)

English

[Product Specifications](#)

[Application Specification](#)

English