



Rail D-Sub Backshells

TE Internal #: 1-2308340-3

Shielded, Single or Dual Cable Entry, Zinc, Straight, Shell Size 1, 9 / 15 Position, Crimp Ferrule Termination, Rail D-Sub Backshells

[View on TE.com >](#)

Connectors > Connector Accessories > Connector Backshells > D-Sub Backshell Size 1

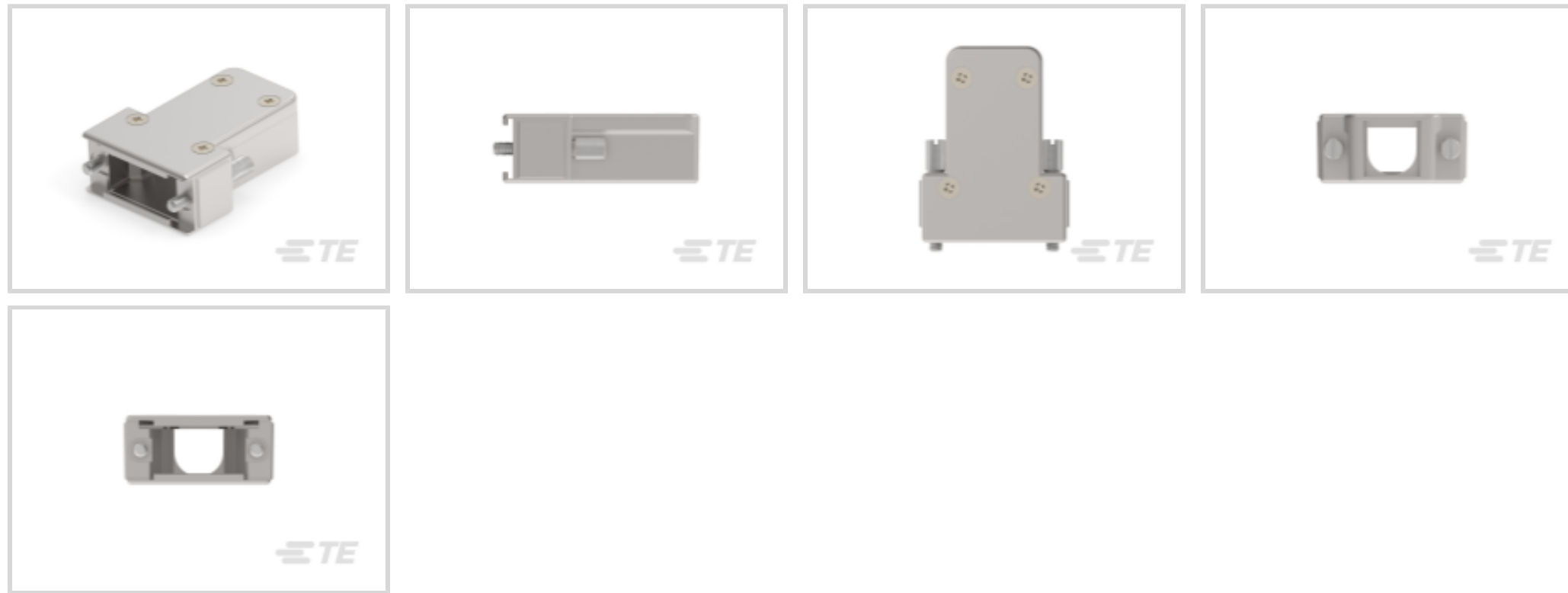

Connector Backshell Product Style: **Shielded**
 Connector Backshell Product Type: **Single or Dual Cable Entry**
 Primary Product Material: **Zinc**
 Body Orientation: **Straight**
 Compatible With Connector Shell Size: **1**

[All D-Sub Backshell Size 1 \(12\)](#)

Features

Product Type Features

Connector Backshell Product Style	Shielded
Connector Backshell Product Type	Single or Dual Cable Entry
Sealable	No
Termination Device Type	Crimp Ferrule

Configuration Features

Number of Positions	9, 15
---------------------	-------

Body Features

Primary Product Material	Zinc
Cable Exit Angle	180°

Mechanical Attachment

Mating Retention Type	Jackscrew
Thread Size	4-40 UNC

Housing Features



Body Orientation	Straight
Compatible With Connector Shape	D-Shaped

Usage Conditions

Operating Temperature Range	-40 – 90 °C[-40 – 194 °F]
-----------------------------	---------------------------

Operation/Application

Compatible With Connector Shell Size	1
--------------------------------------	---

Industry Standards

UL Flammability Rating	UL 94V-0
------------------------	----------

Product Compliance

For compliance documentation, visit the product page on [TE.com](#)>

EU RoHS Directive 2011/65/EU	Compliant with Exemptions
EU ELV Directive 2000/53/EC	Compliant
China RoHS 2 Directive MIIT Order No 32, 2016	Restricted Materials Above Threshold
EU REACH Regulation (EC) No. 1907/2006	Current ECHA Candidate List: JUNE 2023 (235) Candidate List Declared Against: JUNE 2023 (235) SVHC > Threshold: Pb (3.5% in Component Part) Article Safe Usage Statements: Do not eat, drink or smoke when using this product. Wash thoroughly after handling. Recycle if possible and dispose of the article by following all applicable governmental regulations relevant to your geographic location.
Halogen Content	Low Halogen - Br, Cl, F, I < 900 ppm per homogenous material. Also BFR/CFR/PVC Free
Solder Process Capability	Not reviewed for solder process capability

Product Compliance Disclaimer

This information is provided based on reasonable inquiry of our suppliers and represents our current actual knowledge based on the information they provided. This information is subject to change. The part numbers that TE has identified as EU RoHS compliant have a maximum concentration of 0.1% by weight in homogenous materials for lead, hexavalent chromium, mercury, PBB, PBDE, DBP, BBP, DEHP, DIBP, and 0.01% for cadmium, or qualify for an exemption to these limits as defined in the Annexes of Directive 2011/65/EU (RoHS2). Finished electrical and electronic equipment products will be CE marked as required by Directive 2011/65/EU. Components may not be CE marked. Additionally, the part numbers that TE has identified as EU ELV compliant have a maximum concentration of 0.1% by weight in homogenous materials for lead, hexavalent chromium, and mercury, and 0.01% for cadmium, or qualify for an exemption to these limits as defined in the Annexes of Directive 2000/53/EC (ELV). Regarding the REACH Regulation, the information TE provides on SVHC in articles for this part number is based on the latest European Chemicals Agency (ECHA) 'Guidance on requirements for substances in articles' posted at this URL: <https://echa.europa.eu/guidance-documents/guidance-on-reach>

Compatible Parts



Also in the Series | Rail D-Sub Backshells

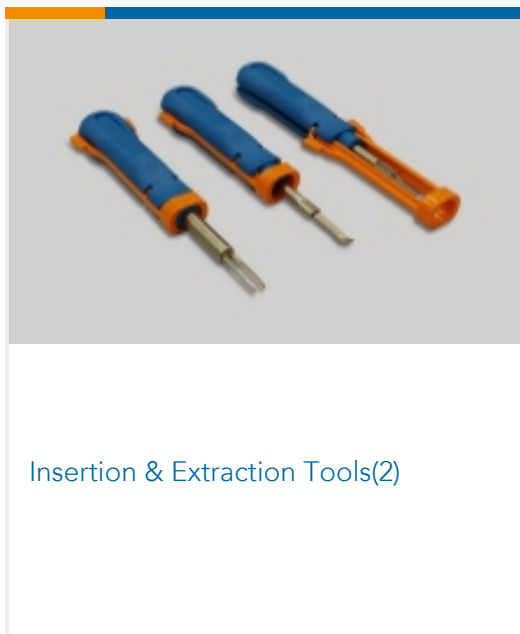
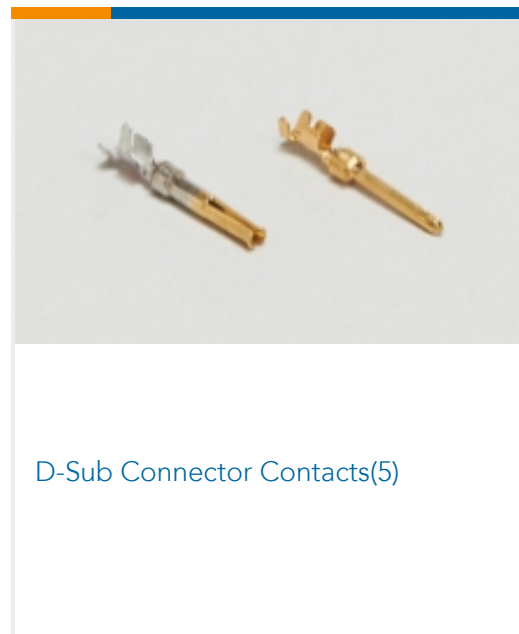
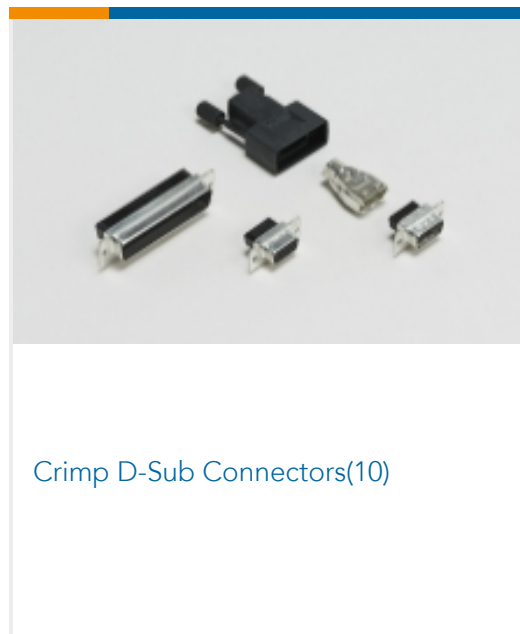
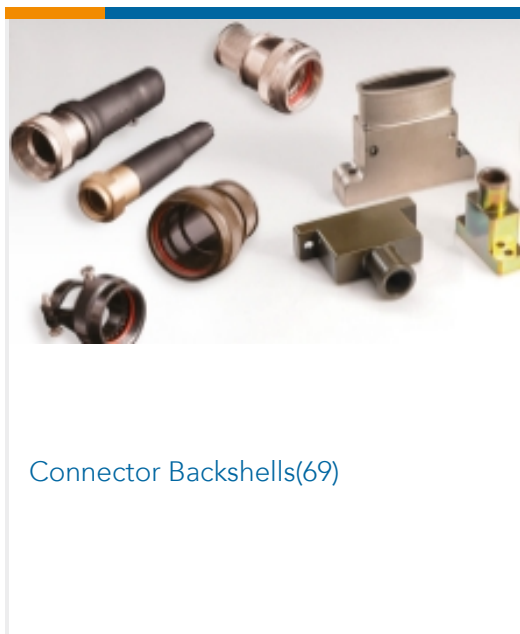

Customers Also Bought

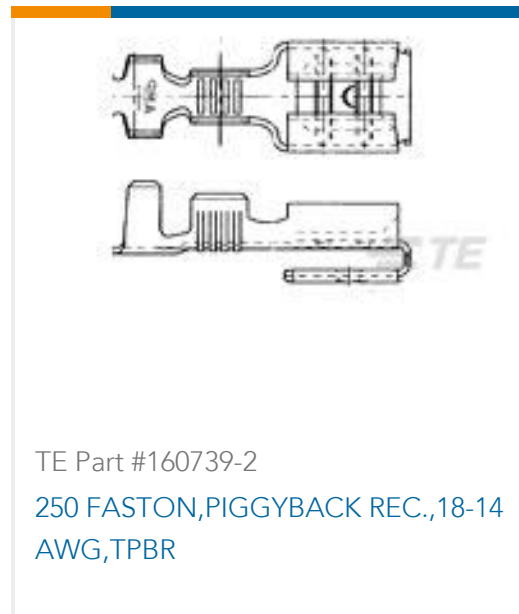

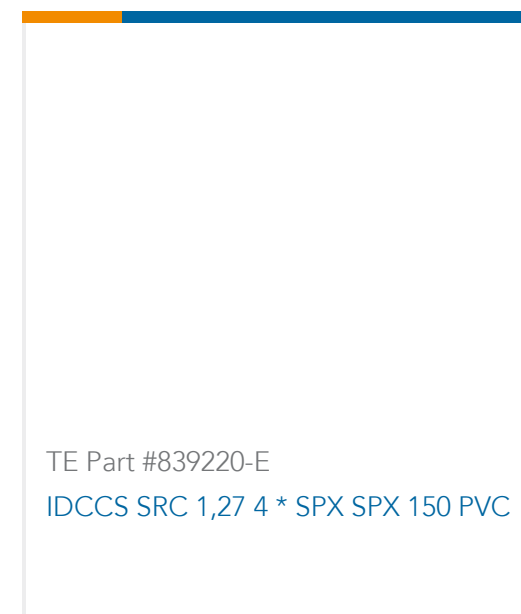

Documents

Product Drawings

FULL METAL HOODS SIZE 1-3 (RAW 180 DEG)

English

CAD Files

3D PDF

3D

Customer View Model

[ENG_CVM_CVM_1-2308340-3_A.2d_dxf.zip](#)

English

Customer View Model

[ENG_CVM_CVM_1-2308340-3_A.3d_igs.zip](#)

English

Customer View Model

[ENG_CVM_CVM_1-2308340-3_A.3d_stp.zip](#)

English

By downloading the CAD file I accept and agree to the [Terms and Conditions](#) of use.

Datasheets & Catalog Pages

Rail D-Sub Backshells Flyer

English