



Rail D-Sub Backshells

TE Internal #: 1-2308273-2

Rectangular Connector Hardware, Quick Lock Pins, -40 – 90 °C [-40 – 194 °F], Rail D-Sub Backshells

[View on TE.com >](#)

Connectors > Rectangular Connectors > Rectangular Connector Accessories > Rectangular Connector Hardware >

Quick Lock Pins for D-Sub Backshells



Connector Hardware Type: **Quick Lock Pins**

Operating Temperature Range: **-40 – 90 °C [-40 – 194 °F]**

[All Quick Lock Pins for D-Sub Backshells \(2\)](#)

Features

Mechanical Attachment

Thread Size	4-40 UNC
Connector Hardware Type	Quick Lock Pins

Usage Conditions

Operating Temperature Range	-40 – 90 °C[-40 – 194 °F]
-----------------------------	---------------------------

Packaging Features

Packaging Quantity	500
Packaging Method	Box

Product Compliance

[For compliance documentation, visit the product page on TE.com>](#)

EU RoHS Directive 2011/65/EU	Compliant with Exemptions
EU ELV Directive 2000/53/EC	Compliant with Exemptions
China RoHS 2 Directive MIIT Order No 32, 2016	Restricted Materials Above Threshold

EU REACH Regulation (EC) No. 1907/2006
 Current ECHA Candidate List: JUNE 2023 (235)
 Candidate List Declared Against: JUNE 2023 (235)
 SVHC > Threshold:
 Pb (3.5% in Component Part)

Article Safe Usage Statements:
 Do not eat, drink or smoke when using this product. Wash thoroughly after handling. Recycle if possible and dispose of the article by following all applicable governmental regulations relevant to your geographic location.





Halogen Content	Low Halogen - Br, Cl, F, I < 900 ppm per homogenous material. Also BFR/CFR/PVC Free
-----------------	---

Solder Process Capability	Not reviewed for solder process capability
---------------------------	--



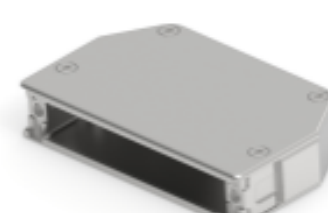

Product Compliance Disclaimer

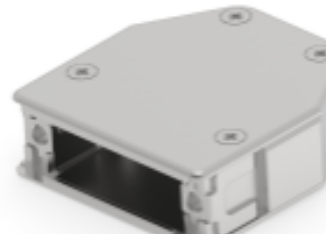
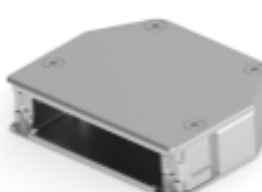
This information is provided based on reasonable inquiry of our suppliers and represents our current actual knowledge based on the information they provided. This information is subject to change. The part numbers that TE has identified as EU RoHS compliant have a maximum concentration of 0.1% by weight in homogenous materials for lead, hexavalent chromium, mercury, PBB, PBDE, DBP, BBP, DEHP, DIBP, and 0.01% for cadmium, or qualify for an exemption to these limits as defined in the Annexes of Directive 2011/65/EU (RoHS2). Finished electrical and electronic equipment products will be CE marked as required by Directive 2011/65/EU. Components may not be CE marked. Additionally, the part numbers that TE has identified as EU ELV compliant have a maximum concentration of 0.1% by weight in homogenous materials for lead, hexavalent chromium, and mercury, and 0.01% for cadmium, or qualify for an exemption to these limits as defined in the Annexes of Directive 2000/53/EC (ELV). Regarding the REACH Regulation, the information TE provides on SVHC in articles for this part number is based on the latest European Chemicals Agency (ECHA) 'Guidance on requirements for substances in articles' posted at this URL: <https://echa.europa.eu/guidance-documents/guidance-on-reach>

Compatible Parts

 <p>TE Part # 1-2308319-1 FULL METAL HOODS SIZE 1 (1)</p>	 <p>TE Part # 1-2308330-1 FULL METAL HOODS SIZE 4 (1)</p>	 <p>TE Part # 1-2308338-1 QL-FULL METAL HOODS SIZE 5 (1 CABLE CLP)</p>	 <p>TE Part # 1-2308321-1 FULL METAL HOODS SIZE 2, (1)</p>
 <p>TE Part # 1-2308327-1 FULL METAL HOODS SIZE 3 (1)</p>			

Also in the Series | Rail D-Sub Backshells

 <p>Connector Backshells(69)</p>	 <p>Connector Strain Relief(53)</p>	 <p>Crimp D-Sub Connectors(10)</p>	 <p>D-Sub Connector Contacts(5)</p>
---	--	---	--

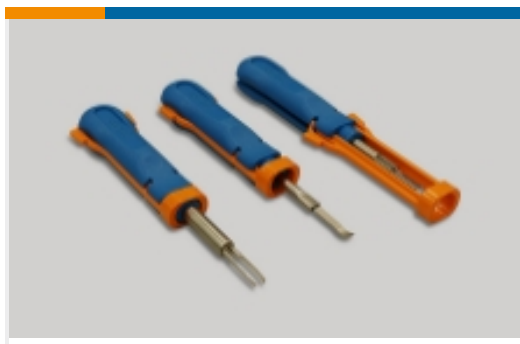

Insertion & Extraction Tools(2)



Rectangular Connector Hardware(19)

Customers Also Bought

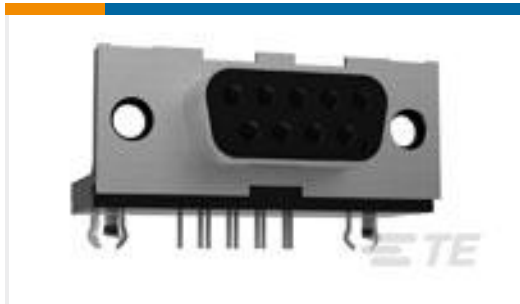

TE Part #3-106507-2
25P.HDP20 REC.ASSY.



TE Part #2-1676625-7
HSA25 240R 5%



TE Part #1-1415526-1
PT78742



TE Part #5-1419111-9
PT28800

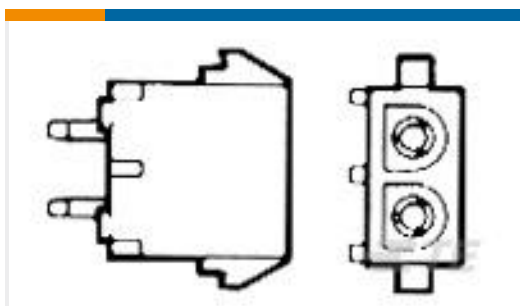

TE Part #350789-3
03P UMNL PIN HDR ASSY 94VO



TE Part #34150
PG R 22-16 COMM 22-18 MIL 1/4



TE Part #3-643813-2
02P MTA100 CONN ASSY POL RIB



TE Part #SL630-C01
5-24VDC,TTL(HI=DRY)OUT

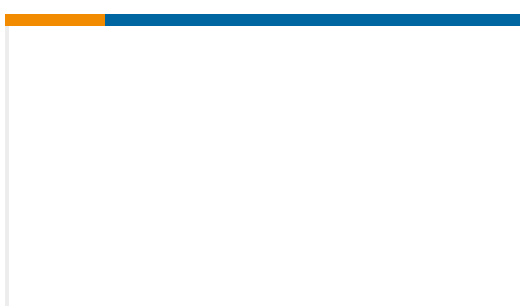

TE Part #1393558-4
C42334A 421C 42 *Z150

Documents

Product Drawings

[QL-SET VARA W/STP MO FOR COMBLOCK 440UNC](#)

English

CAD Files

Customer View Model

[ENG_CVM_CVM_1-2308273-2_A.2d_dxf.zip](#)

English

Customer View Model



[ENG_CVM_CVM_1-2308273-2_A.3d_igs.zip](#)

English

[3D PDF](#)

3D

Customer View Model

[ENG_CVM_CVM_1-2308273-2_A.3d_stp.zip](#)

English

By downloading the CAD file I accept and agree to the [Terms and Conditions](#) of use.

Datasheets & Catalog Pages

[Rail D-Sub Backshells Flyer](#)

English