

1-2303813-3 ✓ ACTIVE

DEUTSCH | DEUTSCH DT

TE Internal #: 1-2303813-3

Housing for Male Terminals, Wire-to-Wire, 3 Position, .394 in [10.01 mm] Centerline, Sealable, Black, Wire & Cable, Power & Signal, DEUTSCH DT

[View on TE.com >](#)



Connectors > Automotive Connectors > Automotive Housings > DEUTSCH DT Receptacle Connectors



Connector System: **Wire-to-Wire**

Number of Positions: **3**

Connector & Housing Type: **Housing for Male Terminals**

Centerline (Pitch): **10.01 mm [.394 in]**

Sealable: **Yes**

[All DEUTSCH DT Receptacle Connectors \(241\)](#)

Features

Product Type Features

Mixed & Hybrid Connector	No
Connector Shape	Triangular
Connector System	Wire-to-Wire
Connector & Housing Type	Housing for Male Terminals
Sealable	Yes
Connector & Contact Terminates To	Wire & Cable
Primary Locking Feature	Integrated in Housing

Configuration Features

Blank Cavity Position	0
Number of Positions	3

Electrical Characteristics

Operating Voltage	250 VAC
-------------------	---------



Nominal Voltage Architecture	12 V, 24 V, 48 V
------------------------------	------------------

Body Features

Cable Exit Angle	180°
Primary Product Color	Black

Contact Features

Contact Size	Size 16
Contact Type	Pin
Mating Pin Diameter	1.59 mm[.063 in]
Contact Current Rating (Max)	13 A

Mechanical Attachment

Terminal Position Assurance	Yes
Strain Relief	Add By Accessory
Mating Alignment Type	Polarized
Mating Alignment	With
Connector Mounting Type	Cable Mount (Free-Hanging)

Housing Features

Housing Material	PA GF
Centerline (Pitch)	10.01 mm[.394 in]

Dimensions

Connector Height	24.71 mm[.973 in]
Product Width	21.13 mm[.832 in]
Product Length	45.93 mm[1.808 in]
Compatible Insulation Diameter Range	2.23 – 3.68 mm[.088 – .145 in]

Usage Conditions

Operating Temperature (Max)	125 °C[257 °F]
Operating Temperature Range	-55 – 125 °C[-67 – 257 °F]

Operation/Application

Circuit Application	Power & Signal
---------------------	----------------

Industry Standards

Degree of Protection	IP68, IP6K9K
Agency/Standard	SAE J2030
UL Flammability Rating	12mm Flame Test per Standard UL-94



Packaging Features

Packaging Quantity	800
Packaging Method	Box

Other

Serviceable	Yes
Connector Position Assurance Capable	No

Product Compliance

[For compliance documentation, visit the product page on TE.com>](#)

EU RoHS Directive 2011/65/EU	Compliant
EU ELV Directive 2000/53/EC	Compliant
China RoHS 2 Directive MIIT Order No 32, 2016	No Restricted Materials Above Threshold
EU REACH Regulation (EC) No. 1907/2006	Current ECHA Candidate List: JUNE 2023 (235) Candidate List Declared Against: JUNE 2023 (235) SVHC > Threshold: Octamethylcyclotetrasiloxane (D4) (.5% in Component Part) Dodecamethylcyclohexasiloxane (D6) (.5% in Component Part) Decamethylcyclopentasiloxane (D5) (.5% in Component Part) Article Safe Usage Statements: Wash thoroughly after handling. Recycle if possible and dispose of the article by following all applicable governmental regulations relevant to your geographic location.
Halogen Content	Not Low Halogen - contains Br or Cl > 900 ppm.
Solder Process Capability	Not reviewed for solder process capability

Product Compliance Disclaimer

This information is provided based on reasonable inquiry of our suppliers and represents our current actual knowledge based on the information they provided. This information is subject to change. The part numbers that TE has identified as EU RoHS compliant have a maximum concentration of 0.1% by weight in homogenous materials for lead, hexavalent chromium, mercury, PBB, PBDE, DBP, BBP, DEHP, DIBP, and 0.01% for cadmium, or qualify for an exemption to these limits as defined in the Annexes of Directive 2011/65/EU (RoHS2). Finished electrical and electronic equipment products will be CE marked as required by Directive 2011/65/EU. Components may not be CE marked. Additionally, the part numbers that TE has identified as EU ELV compliant have a maximum concentration of 0.1% by weight in homogenous materials for lead, hexavalent chromium, and mercury, and 0.01% for cadmium, or qualify for an exemption to these limits as defined in the Annexes of Directive 2000/53/EC (ELV). Regarding the REACH Regulation, the information TE provides on SVHC in articles for this part number is based on the latest European Chemicals Agency (ECHA) 'Guidance on requirements for substances in articles' posted at this URL: <https://echa.europa.eu/guidance-documents/guidance-on-reach>



Compatible Parts



TE Part # CAT-J41-DDPC
DEUTSCH DT Plug Connectors



TE Part # CAT-D48-SP729
DEUTSCH Sealing Plugs



TE Part # CAT-D48-ST273
DEUTSCH Solid Contacts



TE Part # CAT-D487-M8649
DEUTSCH DT Mounting Clips



TE Part # CAT-D487-W416
WedgeLocks: DEUTSCH DT



TE Part # CAT-J67-DSCC16
DEUTSCH Size 16 Crimp Contacts



TE Part # 2-2303816-3
DT06-3S-TN82, PLG, 3P, BLK, N, SNAPXCAP



TE Part # DT3P-DC
PROTECT CVR, 3P, REC, GRY, DT



TE Part # 1924487-2
MOUNTING CLIP, AMPSEAL 16



TE Part # CAT-D487-CH8172
DEUTSCH DT Series Housings & Connectors



TE Part # DT-RT1
EXT TOOL, FRONT RELEASE



TE Part # 2300908-1
0460-003-16329, PIN, SOLID, 20-24AWG, AU



TE Part # 1-2303816-2
DT06-3S-TN31, PLG, 3P, GRY, N, SNAPXCAP



TE Part # 1-2303816-3
DT06-3S-TN32, PLG, 3P, BLK, N, SNAPXCAP



TE Part # 2-2303816-2
DT06-3S-TN81, PLG, 3P, GRY, N, SNAPXCAP



TE Part # CAT-D48-SFT273
DEUTSCH Stamped and Formed Contacts

Also in the Series | DEUTSCH DT



Automotive Connector Caps & Covers (19)



Automotive Connector Locks & Position Assurance(74)



Automotive Housings(620)



Connector Backshells(58)

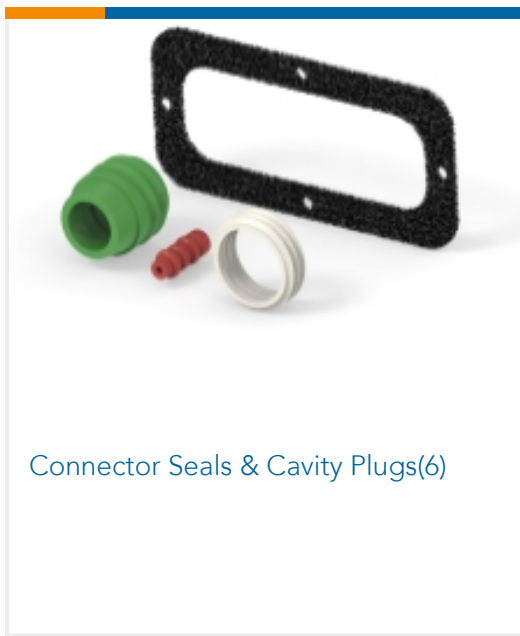

Connector Seals & Cavity Plugs(6)

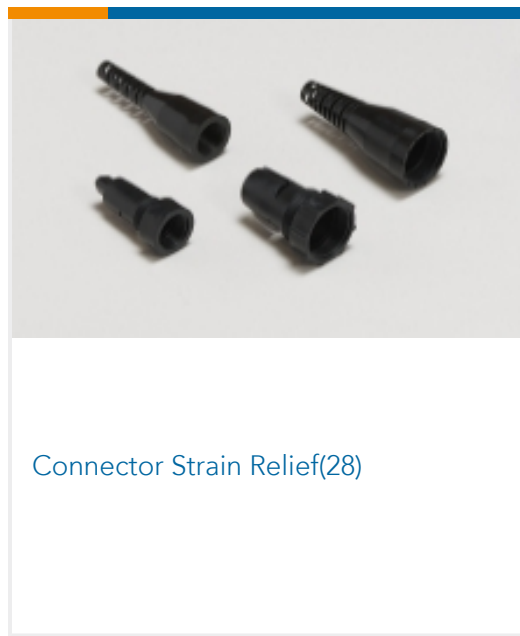

Connector Strain Relief(28)

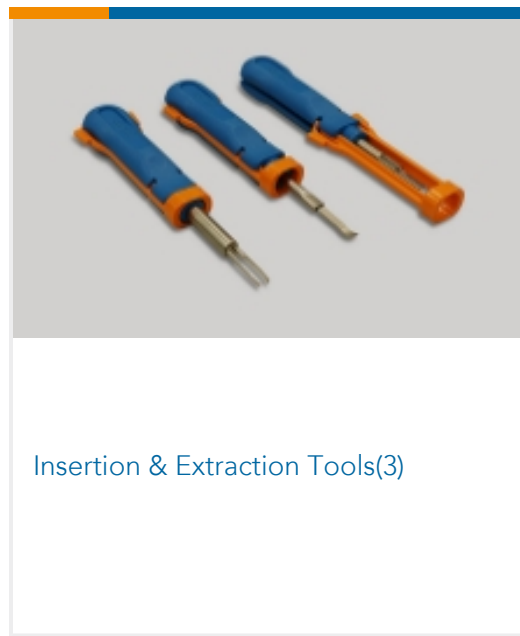

Insertion & Extraction Tools(3)

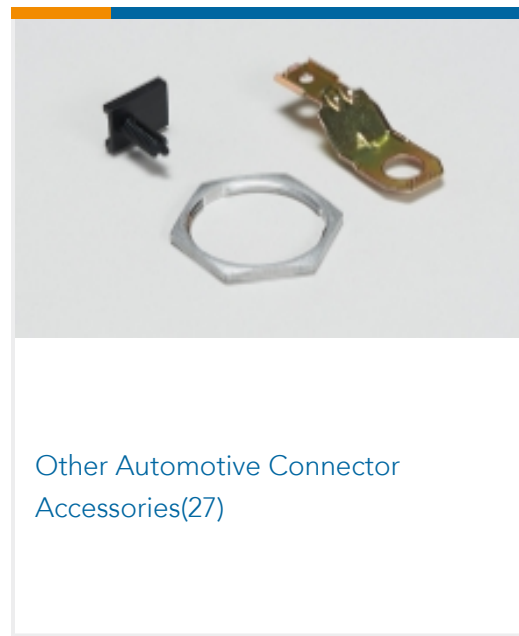

Other Automotive Connector Accessories(27)



PCB Headers & Receptacles(103)

Customers Also Bought



TE Part #1011-349-1205
DUST CAP, 12P, PLG, BLK, DT



TE Part #6609009-4
20EJH1=F7894A S0

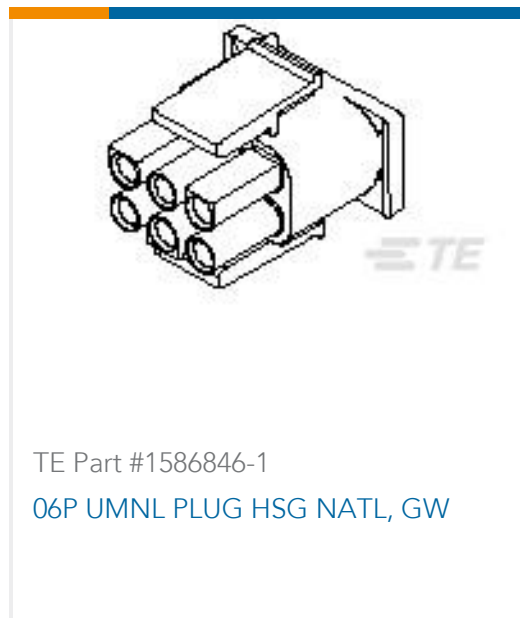

TE Part #1586846-1
06P UMNL PLUG HSG NATL, GW



TE Part #42036-2
RING TERMINAL 22-18 AWG BR



TE Part #1-1625892-9
3W SM M/OX 5% 180R



TE Part #0460-215-16141
PIN, SOLID, SIZE 16, 14AWG, NI



TE Part #1-2303812-1
DT04-2P-TE31, REC, 2P, GRY, E, SNAPCAP



TE Part #1-2303816-2
DT06-3S-TN31, PLG, 3P, GRY, N, SNAPCAP

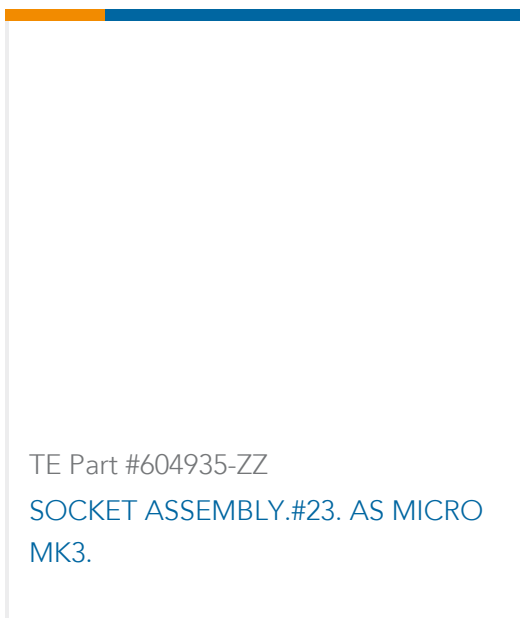

TE Part #604935-ZZ
SOCKET ASSEMBLY.#23. AS MICRO MK3.

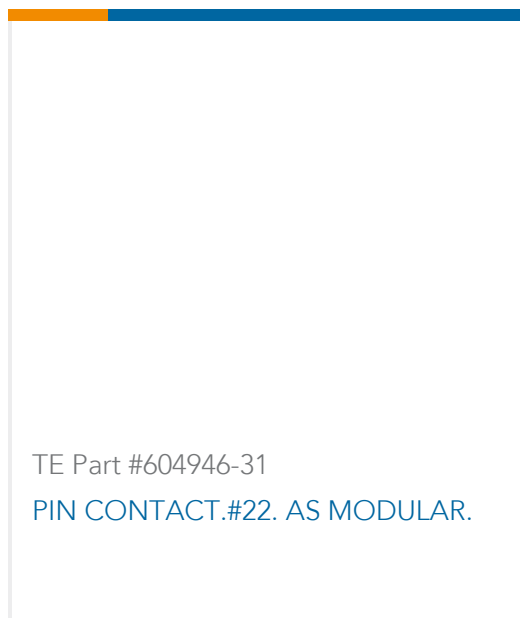

TE Part #604946-31
PIN CONTACT.#22. AS MODULAR.

Documents



Product Drawings

[DT04-3P-TN32, REC, 3P, BLK, N, SNAPCAP](#)

English

CAD Files

[3D PDF](#)

3D

Customer View Model

[ENG_CVM_CVM_1-2303813-3_A.2d_dxf.zip](#)

English

Customer View Model

[ENG_CVM_CVM_1-2303813-3_A.3d_igs.zip](#)

English

Customer View Model

[ENG_CVM_CVM_1-2303813-3_A.3d_stp.zip](#)

English

By downloading the CAD file I accept and agree to the [Terms and Conditions](#) of use.

Product Specifications

[Application Specification](#)

English

Agency Approvals

[UL Report](#)

English