

1-215570-8 ✓ ACTIVE

Micro-MaTch | Micro-MaTch Industrial

TE Internal #: 1-215570-8

PCB Mount Paddleboard Connector, Vertical, Cable-to-Board, 18
Position, .05 in [1.27 mm] Centerline, Ribbon Cable, Micro-MaTch
Industrial

[View on TE.com >](#)



Connectors > PCB Connectors > Board-In Connectors > Paddle Board Connector

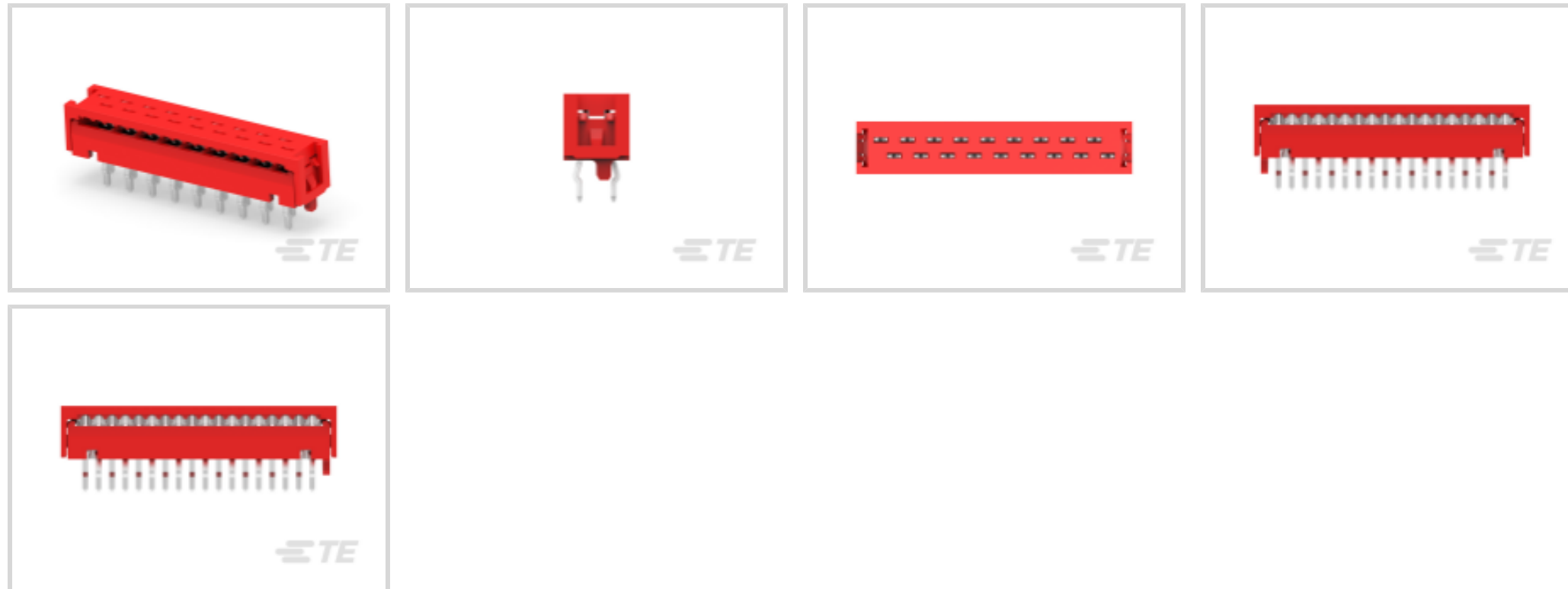

PCB Connector Assembly Type: **PCB Mount Paddleboard Connector**

PCB Mount Orientation: **Vertical**

Connector System: **Cable-to-Board**

Number of Positions: **18**

Centerline (Pitch): **1.27 mm [.05 in]**

[All Paddle Board Connector \(20\)](#)

Features

Product Type Features

PCB Connector Assembly Type	PCB Mount Paddleboard Connector
Connector System	Cable-to-Board
Connector & Contact Terminates To	Printed Circuit Board, Wire & Cable

Configuration Features

Wire Entry Location	Top
PCB Mount Orientation	Vertical
Number of Positions	18
Compatible With Wire & Cable Type	Ribbon Cable
Number of Rows	2

Electrical Characteristics

Insulation Resistance	1000 MΩ
Operating Voltage	100 VAC



Body Features

Primary Product Color	Red
-----------------------	-----

Contact Features

PCB Contact Termination Area Plating Material Thickness	3 – 5 μm [118.11 – 196.85 μin]
Wire Contact Termination Area Plating Thickness	1 μm [39.37 μin]
Wire Contact Termination Area Plating Material Finish	Matte
Wire Contact Termination Area Plating Material	Tin
PCB Contact Termination Area Plating Material Finish	Matte
Contact Underplating Material	Nickel
PCB Contact Termination Area Plating Material	Tin
Contact Base Material	Phosphor Bronze
Contact Current Rating (Max)	1.5 A

Termination Features

Rectangular Termination Post & Tail Thickness	.5 mm[.02 in]
Rectangular Termination Post & Tail Width	.4 mm[.015 in]
Termination Post & Tail Length	3.2 mm[.125 in]
Termination Method to Printed Circuit Board	Through Hole - Solder

Mechanical Attachment

PCB Mount Retention Type	Kinked Solder Tails
PCB Mount Alignment	With
PCB Mount Retention	With

Housing Features

Centerline (Pitch)	1.27 mm[.05 in]
Housing Material	PBT GF

Dimensions

Connector Length	26.3 mm[1.035 in]
Connector Height	5.1 mm[.2 in]
Row-to-Row Spacing	2 mm[.059 in]
Compatible Insulation Diameter Range	.8 – 1 mm[.035 – .039 in]
Wire Size	.08 – .09 mm ²

Usage Conditions

Operating Temperature Range	-40 – 105 °C[-40 – 221 °F]
-----------------------------	----------------------------



Operation/Application

Solder Process Feature	Board Standoff
Circuit Application	Signal

Industry Standards

Approved Standards	UL E28476
UL Flammability Rating	UL 94V-0

Packaging Features

Packaging Quantity	2500
Packaging Type	Reel

Product Compliance

[For compliance documentation, visit the product page on TE.com>](#)

EU RoHS Directive 2011/65/EU	Compliant
EU ELV Directive 2000/53/EC	Compliant
China RoHS 2 Directive MIIT Order No 32, 2016	No Restricted Materials Above Threshold
EU REACH Regulation (EC) No. 1907/2006	Current ECHA Candidate List: JUNE 2023 (235) Candidate List Declared Against: JUNE 2023 (235) Does not contain REACH SVHC
Halogen Content	Not Low Halogen - contains Br or Cl > 900 ppm.
Solder Process Capability	Wave solder capable to 265°C

Product Compliance Disclaimer

This information is provided based on reasonable inquiry of our suppliers and represents our current actual knowledge based on the information they provided. This information is subject to change. The part numbers that TE has identified as EU RoHS compliant have a maximum concentration of 0.1% by weight in homogenous materials for lead, hexavalent chromium, mercury, PBB, PBDE, DBP, BBP, DEHP, DIBP, and 0.01% for cadmium, or qualify for an exemption to these limits as defined in the Annexes of Directive 2011/65/EU (RoHS2). Finished electrical and electronic equipment products will be CE marked as required by Directive 2011/65/EU. Components may not be CE marked. Additionally, the part numbers that TE has identified as EU ELV compliant have a maximum concentration of 0.1% by weight in homogenous materials for lead, hexavalent chromium, and mercury, and 0.01% for cadmium, or qualify for an exemption to these limits as defined in the Annexes of Directive 2000/53/EC (ELV). Regarding the REACH Regulation, the information TE provides on SVHC in articles for this part number is based on the latest European Chemicals Agency (ECHA) 'Guidance on requirements for substances in articles' posted at this URL: <https://echa.europa.eu/guidance-documents/guidance-on-reach>

Compatible Parts

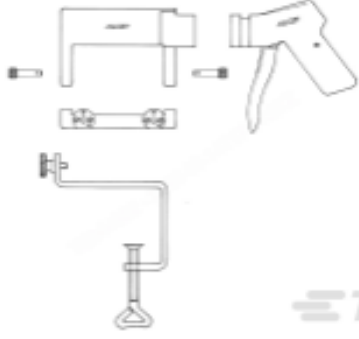

TE Part # 734155-1
Micro-MaTch HANDTOOL KIT w.o. ADAPTER



TE Part # 734024-1
Micro-MaTch ADAPTER, 4-24 POS.

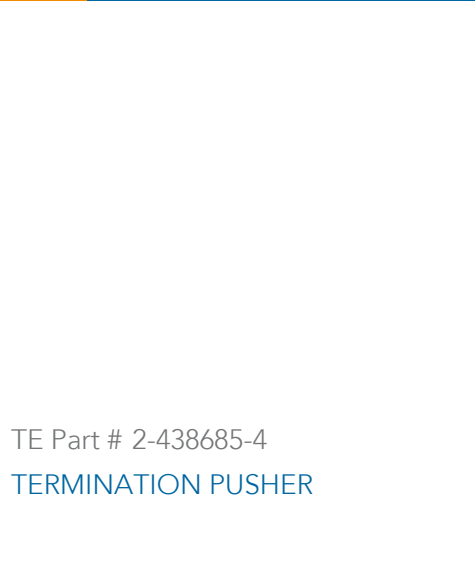

TE Part # 2-438685-4
TERMINATION PUSHER



TE Part # 438685-1
TERM.PUSHER ASSY



TE Part # 677412-4
SEMI AUTO.MACHINE, MICRO-MATCH, 4-24 POS

Also in the Series | Micro-MaTch Industrial



Board-In Connectors(20)



Insertion & Extraction Tools(1)



PCB Headers & Receptacles(1)



Pluggable I/O Cable Assemblies(52)



Ribbon Cable Connectors(185)



Wire-to-Board Connector Contacts(4)

Customers Also Bought



TE Part #640900-1
05P UMNL PIN HDR ASSY 94VO



TE Part #DT15-12PB
DEUTSCH DT Headers

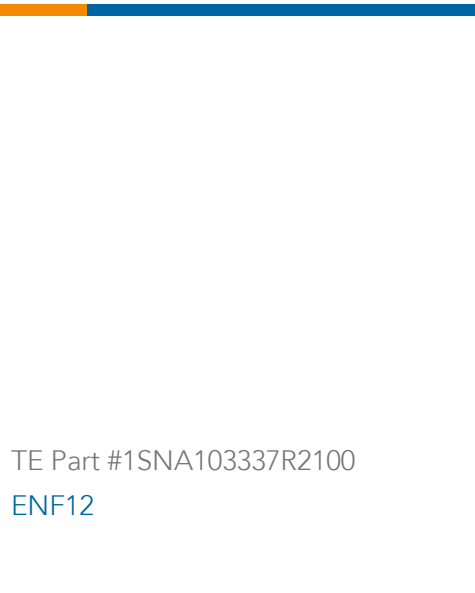

TE Part #1SNA103337R2100
ENF12

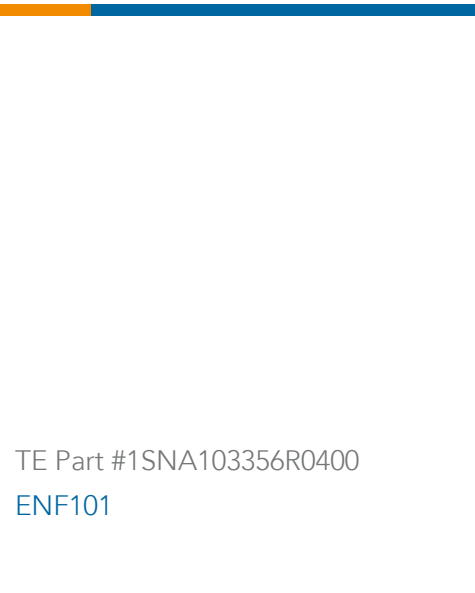

TE Part #1SNA103356R0400
ENF101

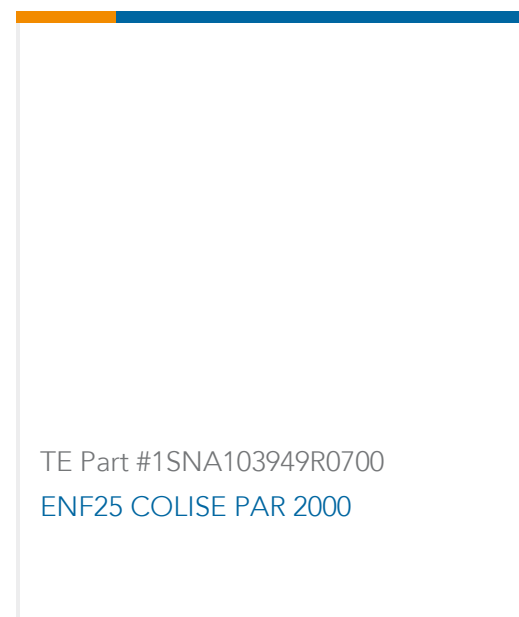
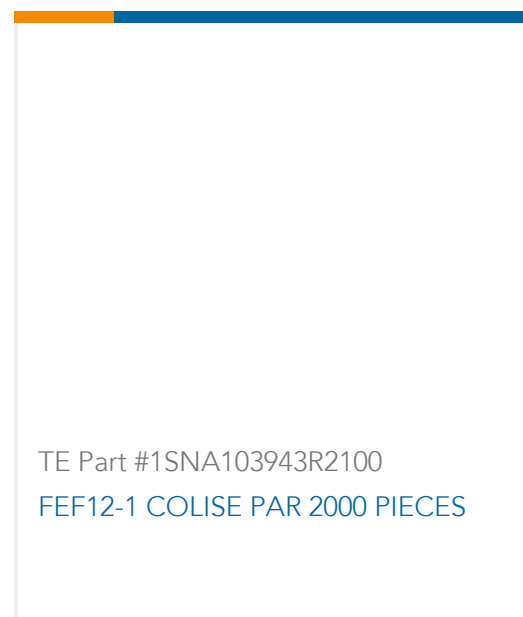

Documents

Product Drawings

[MICRO-MATCH PBC.18P](#)

English

CAD Files

[3D PDF](#)

3D

[Customer View Model](#)

[ENG_CVM_CVM_1-215570-8_S.2d_dxf.zip](#)

English

[Customer View Model](#)

[ENG_CVM_CVM_1-215570-8_S.3d_igs.zip](#)

English

[Customer View Model](#)

[ENG_CVM_CVM_1-215570-8_S.3d_stp.zip](#)

English

By downloading the CAD file I accept and agree to the [Terms and Conditions](#) of use.

Datasheets & Catalog Pages

[Micro-MaTch Catalog](#)

English

[Ribbon Cable Interconnect Solutions](#)

English

[Centerline Micro-Match Connector Series](#)

English

Product Specifications

[Application Specification](#)

English

[micro match miniature connector system](#)

English