

1-1971906-5 ✓ ACTIVE

GRACE INERTIA 3.3

TE Internal #: 1-1971906-5

Rectangular Power Connectors, Header, Receptacle, Wire-to-Board, 10 Position, 3.3 mm [.129 in] Centerline, Printed Circuit Board, GRACE INERTIA 3.3

[View on TE.com >](#)



Connectors > Power Connectors > Rectangular Power > Rectangular Power Connectors



Rectangular Power Connector Type: **Header**

Connector & Housing Type: **Receptacle**

Connector System: **Wire-to-Board**

Number of Positions: **10**

Centerline (Pitch): **3.3 mm [.129 in]**

Features

Product Type Features

Header Type	Fully Shrouded
Rectangular Power Connector Type	Header
Connector & Housing Type	Receptacle
Connector System	Wire-to-Board
Sealable	No
Connector & Contact Terminates To	Printed Circuit Board

Configuration Features

Number of Positions	10
PCB Mount Orientation	Vertical
Number of Power Positions	10
Number of Signal Positions	10
Number of Rows	2

Electrical Characteristics

Operating Voltage	250 VDC
-------------------	---------



Body Features

Connector & Keying Code	A
-------------------------	---

Contact Features

Mating Post Length	6.6 mm[.26 in]
PCB Contact Termination Area Plating Material Thickness	2 µm[78.74 µin]
Contact Layout	Matrix
Mating Tab Width	.5 mm[.02 in]
Contact Underplating Material Thickness	1.25 µm[49.21 µin]
Contact Mating Area Plating Material	Tin
Contact Underplating Material	Nickel
Contact Base Material	Brass
Contact Current Rating (Max)	4 A
Contact Retention Within Housing	With
Contact Type	Pin
PCB Contact Termination Area Plating Material	Tin
Contact Mating Area Plating Material Thickness	78.73 µm[2 µin]

Termination Features

Termination Post & Tail Length	3 mm[.118 in]
Termination Method to Printed Circuit Board	Through Hole - Solder

Mechanical Attachment

PCB Mount Alignment Type	Locating Posts
Mating Alignment Type	Keyed
Mating Retention	With
Mating Alignment	With
PCB Mount Alignment	With
PCB Mount Retention	With
PCB Mount Retention Type	Kinked
Mating Retention Type	Latch
Connector Mounting Type	Board Mount

Housing Features

Centerline (Pitch)	3.3 mm[.129 in]
Housing Color	Natural



Housing Material	PA 66 GF
------------------	----------

Dimensions

Connector Height	14.25 mm[.561 in]
PCB Thickness (Recommended)	.06 mm[1.6 in]
Product Length	18.6 mm[.73 in]
Wire Size	414.44 – 1045.97 CMA
Row-to-Row Spacing	5.2 mm[.205 in]

Usage Conditions

Operating Temperature Range	-30 – 105 °C[-22 – 221 °F]
-----------------------------	----------------------------

Operation/Application

Circuit Application	Power & Signal
---------------------	----------------

Industry Standards

UL Flammability Rating	UL 94V-0
Glow Wire Rating	GWT 750°C (Without Flame)

Packaging Features

Packaging Quantity	200
Packaging Method	Box & Tray

Product Compliance

[For compliance documentation, visit the product page on TE.com>](#)

EU RoHS Directive 2011/65/EU	Compliant
EU ELV Directive 2000/53/EC	Compliant
China RoHS 2 Directive MIIT Order No 32, 2016	No Restricted Materials Above Threshold
EU REACH Regulation (EC) No. 1907/2006	Current ECHA Candidate List: JUNE 2023 (235) Candidate List Declared Against: JAN 2022 (223) Does not contain REACH SVHC
Halogen Content	Not Low Halogen - contains Br or Cl > 900 ppm.
Solder Process Capability	Not reviewed for solder process capability

Product Compliance Disclaimer

This information is provided based on reasonable inquiry of our suppliers and represents our current actual knowledge based on the information they provided. This information is subject to change. The part numbers that TE has identified as EU RoHS compliant have a maximum concentration of 0.1% by weight in homogenous materials for lead, hexavalent

chromium, mercury, PBB, PBDE, DBP, BBP, DEHP, DIBP, and 0.01% for cadmium, or qualify for an exemption to these limits as defined in the Annexes of Directive 2011/65/EU (RoHS2). Finished electrical and electronic equipment products will be CE marked as required by Directive 2011/65/EU. Components may not be CE marked. Additionally, the part numbers that TE has identified as EU ELV compliant have a maximum concentration of 0.1% by weight in homogenous materials for lead, hexavalent chromium, and mercury, and 0.01% for cadmium, or qualify for an exemption to these limits as defined in the Annexes of Directive 2000/53/EC (ELV). Regarding the REACH Regulation, the information TE provides on SVHC in articles for this part number is based on the latest European Chemicals Agency (ECHA) 'Guidance on requirements for substances in articles' posted at this URL: <https://echa.europa.eu/guidance-documents/guidance-on-reach>

Compatible Parts

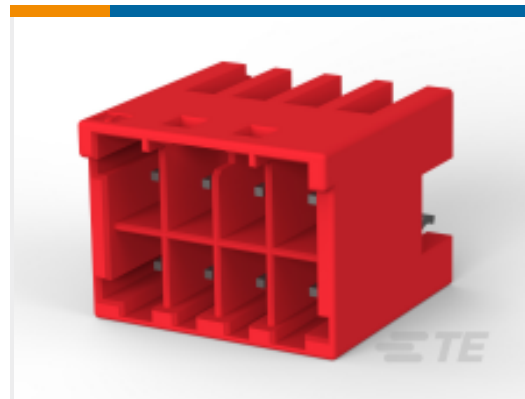

TE Part # 3-1971906-4
HEADER ASSY 8POS,KEYING-C,NEW
GIC3.3



TE Part # 1-1971906-6
HEADER ASSY 12POS,KEYING-A,
NEW GIC3.3

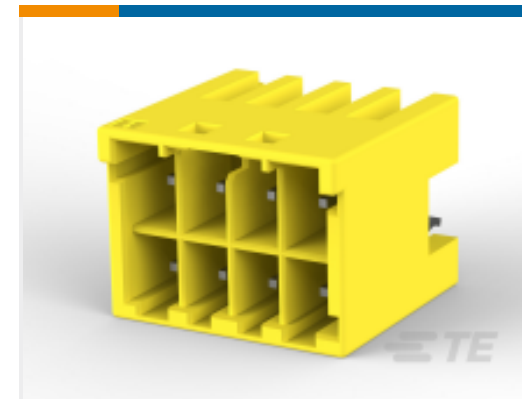

TE Part # 4-1971906-4
HEADER ASSY 8POS,KEYING-D,NEW
GIC3.3



TE Part # 1-1971906-7
HEADER ASSY 14POS,KEYING-A,
NEW GIC3.3



TE Part # 1981065-1
GIC 3.3 10P DBL LOCK PLATE (2ROW,
M TYPE)



TE Part # 1939983-1
GIC3.3 HDR ASS'Y 10POS 2ROW

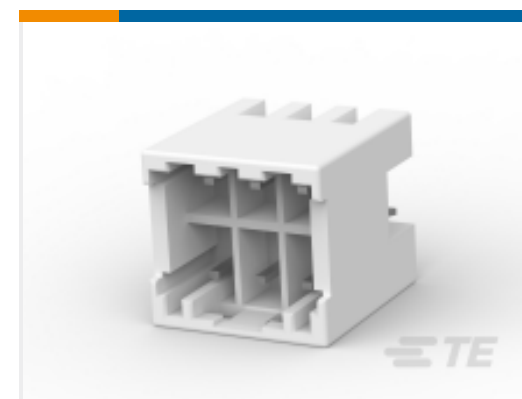

TE Part # 1827392-1
GIC 3.3 HDR ASSY 6P



TE Part # 1-1971906-3
HEADER ASSY 6POS,KEYING-A,NEW
GIC3.3



TE Part # 1871571-1
GIC 3.3 HDR ASSY 12POS KINK

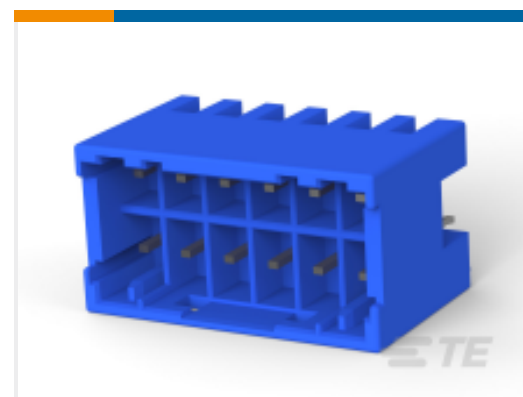

TE Part # 2-1871571-3
GIC 3.3 HEADER ASSY 12POS

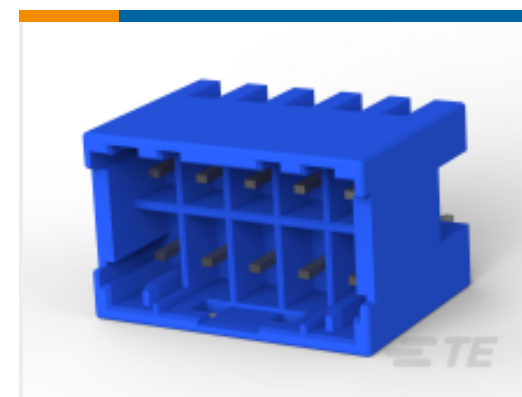

TE Part # 2-1939983-3
GIC 3.3 HDR ASSY 10P 2ROW BLUE

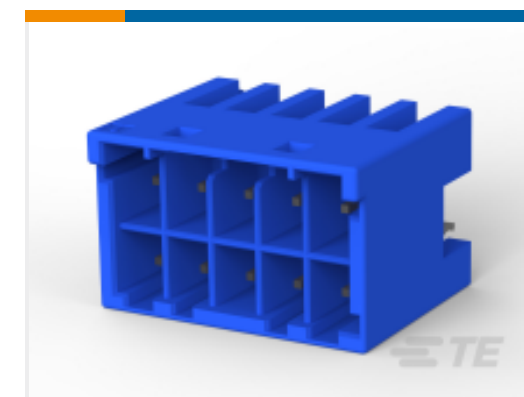

TE Part # 2-1971906-5
HEADER ASSY 10POS,KEYING-B,NEW
GIC3.3

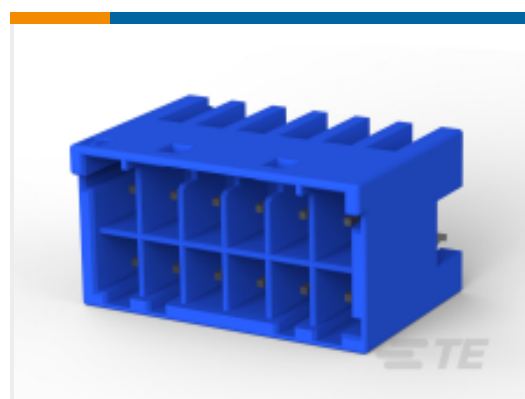

TE Part # 2-1971906-6
HEADER ASSY 12POS,KEYING-B,NEW
GIC3.3



TE Part # 2-1971906-7
HEADER ASSY 14POS,KEYING-B,NEW
GIC3.3

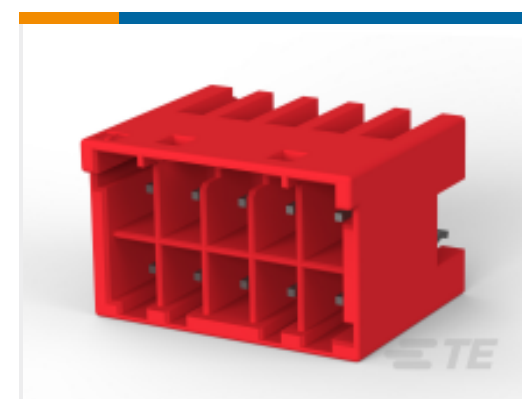

TE Part # 3-1971906-5
HEADER ASSY 10POS,KEYING-C,
NEW GIC3.3

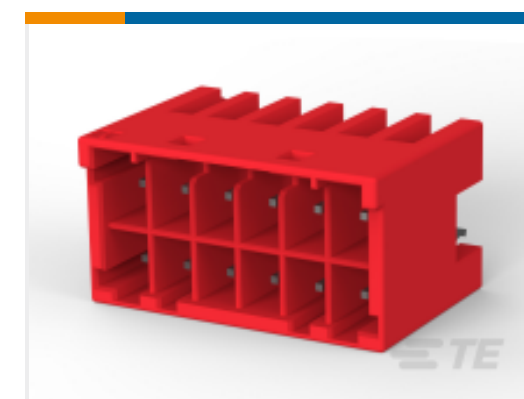

TE Part # 3-1971906-6
HEADER ASSY 12POS,KEYING-C,
NEW GIC3.3



Also in the Series | GRACE INERTIA 3.3

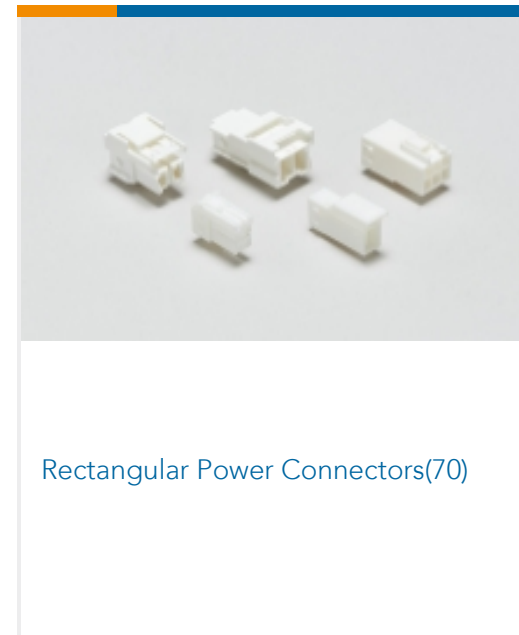
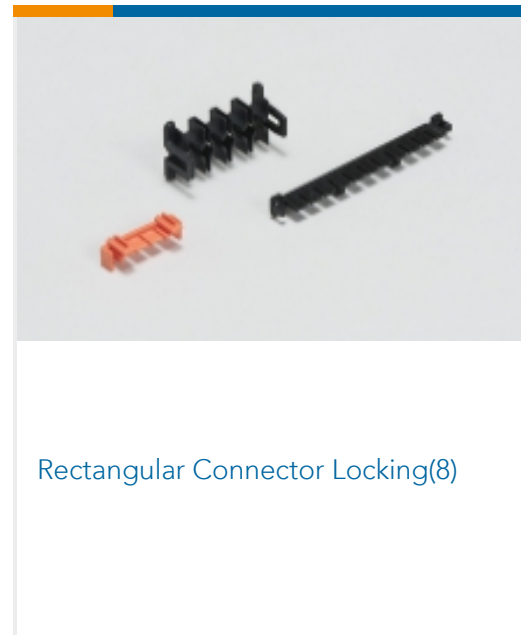
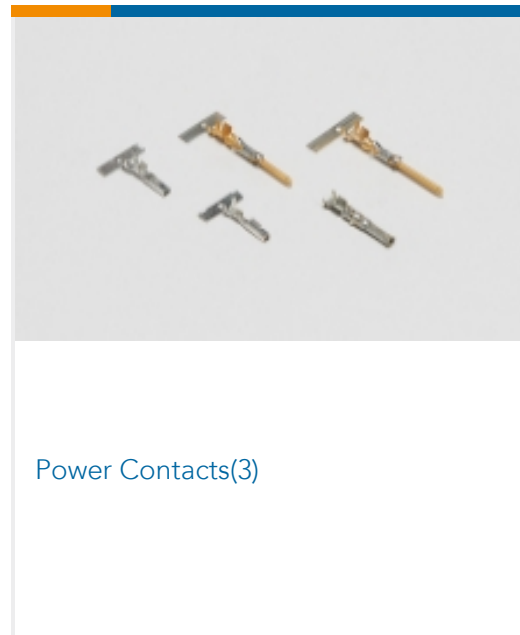
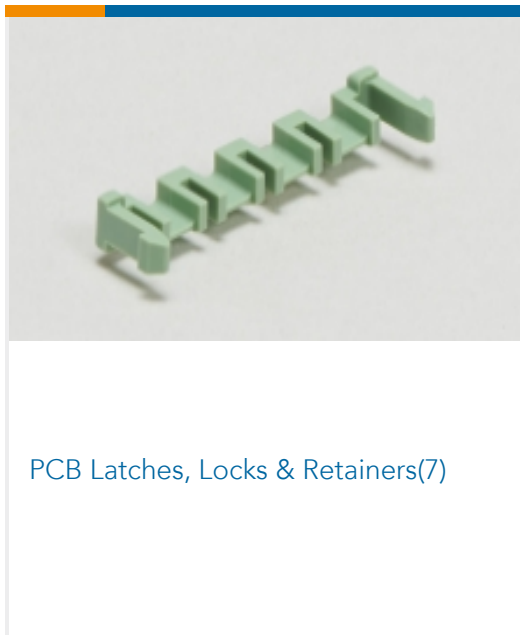

Customers Also Bought

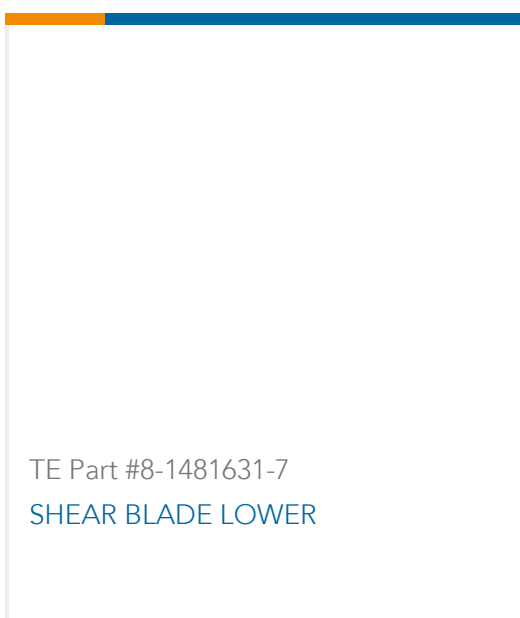
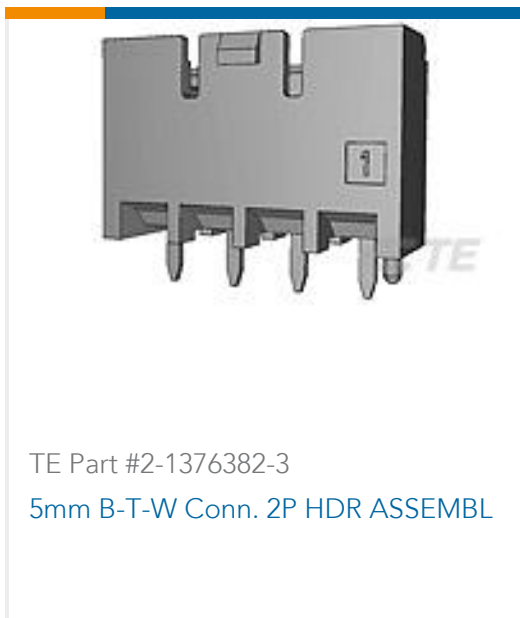



Documents

Product Drawings

[HEADER ASSY 10POS,KEYING-A,NEW GIC3.3](#)

English

CAD Files

[3D PDF](#)

3D

Customer View Model

[ENG_CVM_CVM_1-1971906-5_A_c-1-1971906-5-a.2d_dxf.zip](#)

English

Customer View Model

[ENG_CVM_CVM_1-1971906-5_A_c-1-1971906-5-a.3d_igs.zip](#)

English

Customer View Model

[ENG_CVM_CVM_1-1971906-5_A_c-1-1971906-5-a.3d_stp.zip](#)

English

By downloading the CAD file I accept and agree to the [Terms and Conditions](#) of use.

Datasheets & Catalog Pages

[1-1773883-5 GRACE INERTIA connector quick reference guide](#)

English

[5-1773465-4-GI3.3Flyer](#)

English

[7-1773465-7-GI3.3-ChineseFlyer](#)

[GI3.3_QRG_CN](#)

Product Specifications

[Application Specification](#)

English

Product Environmental Compliance

[TE Material Declaration](#)

English