



CGS | CGS TE

TE Internal #: 1-1879444-7

22 Ω, Wire Wound, Power Resistor, 226 x 28 x 61 mm, 2 Termination, Loose Piece - Box, 5 %, 100 W, ±440 ppm/°C, Solder Lug Termination, Bracket, CGS TE

[View on TE.com >](#)

Passive Components > Resistors > Chassis Mount Resistors > Wirewound Resistor: Mineral, 2.5 Kw



Resistor Type: **Power Resistor**

Passive Component Dimensions: **226 x 28 x 61 mm**

Number of Terminations: **2**

Packaging Method: **Loose Piece - Box**

Passive Component Tolerance: **5 %**

[All Wirewound Resistor: Mineral, 2.5 Kw \(685\)](#)

Features

Product Type Features

| | |
|---------------|----------------|
| Resistor Type | Power Resistor |
| Element Type | Wire Wound |

Configuration Features

| | |
|---------------------|---|
| Number of Resistors | 1 |
|---------------------|---|

Electrical Characteristics

| | |
|-----------------------------|-----------|
| Passive Component Tolerance | 5 % |
| Resistance Class | Up to 1kΩ |
| Resistance Value | 22 Ω |
| Power Rating | 100 W |

Termination Features

| | |
|---|------------|
| Number of Terminations | 2 |
| Chassis Mount Resistor Termination Type | Solder Lug |

Mechanical Attachment

| | |
|------------------------------------|---------|
| Chassis Mount Resistor Mount Style | Bracket |
|------------------------------------|---------|

Dimensions

| | |
|------------------------------|------------------|
| Passive Component Dimensions | 226 x 28 x 61 mm |
|------------------------------|------------------|



Usage Conditions

| | |
|-----------------------------|-----------------------------------|
| Operating Temperature Range | -55 – 155 $^{\circ}\text{C}$ |
| Temperature Coefficient | ± 440 ppm/ $^{\circ}\text{C}$ |

Packaging Features

| | |
|------------------|-------------------|
| Packaging Method | Loose Piece - Box |
|------------------|-------------------|

Product Compliance

[For compliance documentation, visit the product page on TE.com>](#)

| | |
|---|---|
| EU RoHS Directive 2011/65/EU | Compliant |
| EU ELV Directive 2000/53/EC | Compliant |
| China RoHS 2 Directive MIIT Order No 32, 2016 | No Restricted Materials Above Threshold |
| EU REACH Regulation (EC) No. 1907/2006 | Current ECHA Candidate List: JUNE 2023 (235) Candidate List Declared Against: JUNE 2023 (235) Does not contain REACH SVHC |
| Halogen Content | Low Halogen - Br, Cl, F, I < 900 ppm per homogenous material. Also BFR/CFR/PVC Free |
| Solder Process Capability | Not applicable for solder process capability |

Product Compliance Disclaimer

This information is provided based on reasonable inquiry of our suppliers and represents our current actual knowledge based on the information they provided. This information is subject to change. The part numbers that TE has identified as EU RoHS compliant have a maximum concentration of 0.1% by weight in homogenous materials for lead, hexavalent chromium, mercury, PBB, PBDE, DBP, BBP, DEHP, DIBP, and 0.01% for cadmium, or qualify for an exemption to these limits as defined in the Annexes of Directive 2011/65/EU (RoHS2). Finished electrical and electronic equipment products will be CE marked as required by Directive 2011/65/EU. Components may not be CE marked. Additionally, the part numbers that TE has identified as EU ELV compliant have a maximum concentration of 0.1% by weight in homogenous materials for lead, hexavalent chromium, and mercury, and 0.01% for cadmium, or qualify for an exemption to these limits as defined in the Annexes of Directive 2000/53/EC (ELV). Regarding the REACH Regulation, the information TE provides on SVHC in articles for this part number is based on the latest European Chemicals Agency (ECHA) 'Guidance on requirements for substances in articles' posted at this URL: <https://echa.europa.eu/guidance-documents/guidance-on-reach>

Compatible Parts



Also in the Series | CGS TE

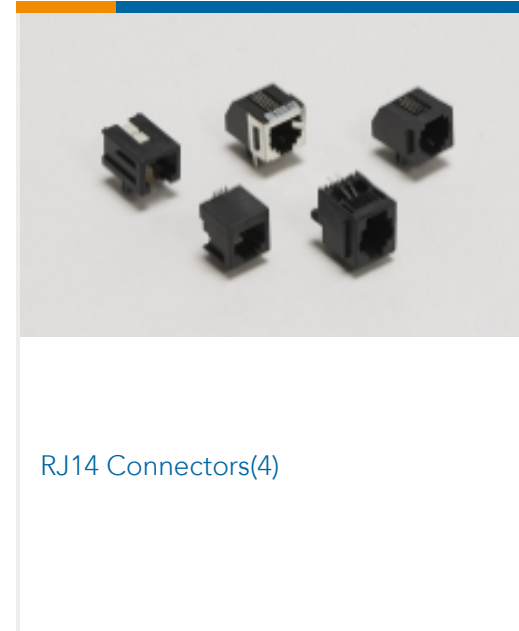

Customers Also Bought

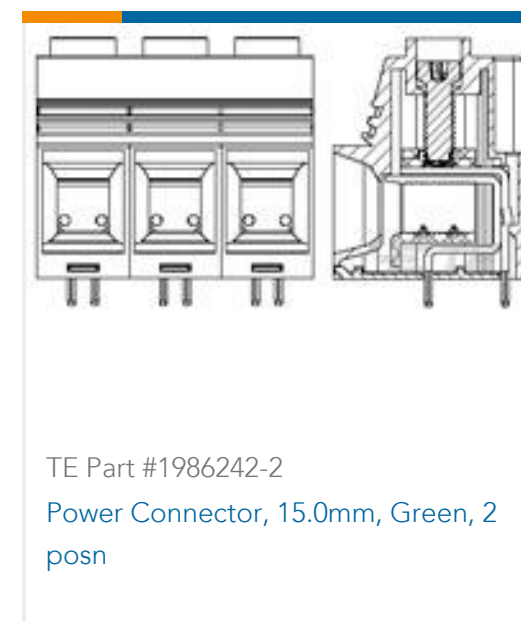



Documents

Product Drawings

[TE 100W 22R 5% Bracket](#)

English

CAD Files

[3D PDF](#)

3D

Customer View Model

[ENG_CVM_CVM_1-1879444-7_BB.2d_dxf.zip](#)

English

Customer View Model

[ENG_CVM_CVM_1-1879444-7_BB.3d_igs.zip](#)

English

Customer View Model

[ENG_CVM_CVM_1-1879444-7_BB.3d_stp.zip](#)

English

By downloading the CAD file I accept and agree to the [Terms and Conditions](#) of use.

Datasheets & Catalog Pages

[4-1773460-6_RESISTIVE_SOLUTIONS_RAIL](#)

English

[1309350_PASSIVE_COMPONENT](#)

English

[8-1773459-4_POWER_FILTERING_AND_RESISTIVE_SOLUTIONS_FOR_ELEVATORS_AND_ESCALATORS](#)

English

[High Power Wire wound Resistor Type TE Series](#)

English