

1-1871935-4 ✓ ACTIVE



[Dynamic Series](#) | [Dynamic 1000 Series](#)

TE Internal #: 1-1871935-4

PCB Mount Header, Horizontal, Wire-to-Board, 8 Position, 3.5 mm [.137 in] Centerline, Fully Shrouded, Gold, Through Hole - Solder, Dynamic 1000 Series

[View on TE.com >](#)

Connectors > PCB Connectors > PCB Headers & Receptacles > DYNAMIC 1900D HDR ASSY



Connector System: **Wire-to-Board**

Number of Positions: **8**

Number of Rows: **2**

Centerline (Pitch): **3.5 mm [.137 in]**

PCB Mount Orientation: **Horizontal**

[All DYNAMIC 1900D HDR ASSY \(9\)](#)

Features

Product Type Features

Connector System	Wire-to-Board
Header Type	Fully Shrouded
Sealable	No
Connector & Contact Terminates To	Printed Circuit Board
PCB Connector Assembly Type	PCB Mount Header

Configuration Features

Number of Positions	8
Number of Rows	2
PCB Mount Orientation	Horizontal

Body Features

Primary Product Color	Black
-----------------------	-------

Contact Features



Contact Mating Area Plating Material Thickness	.38 μm[15 μin]
Contact Mating Area Plating Material	Gold
Contact Type	Pin
Contact Current Rating (Max)	1 A

Termination Features

Termination Method to Printed Circuit Board	Through Hole - Solder
---	-----------------------

Mechanical Attachment

Mating Alignment Type	Keyed
Mating Retention	With
PCB Mount Retention Type	Retention Leg
Connector Mounting Type	Board Mount
Mating Alignment	With
PCB Mount Alignment	Without
PCB Mount Retention	With

Housing Features

Housing Material	Polyester GF
Centerline (Pitch)	3.5 mm [.137 in]

Usage Conditions

Operating Temperature Range	-30 – 105 °C[-22 – 221 °F]
-----------------------------	----------------------------

Operation/Application

Circuit Application	Power & Signal
---------------------	----------------

Industry Standards

UL Flammability Rating	UL 94V-0
------------------------	----------

Packaging Features

Packaging Type	Tube
----------------	------

Product Compliance

[For compliance documentation, visit the product page on TE.com>](#)

EU RoHS Directive 2011/65/EU	Compliant
EU ELV Directive 2000/53/EC	Compliant
China RoHS 2 Directive MIIT Order No 32, 2016	No Restricted Materials Above Threshold
EU REACH Regulation (EC) No. 1907/2006	



Current ECHA Candidate List: JUNE 2023
(235)

Candidate List Declared Against: JUNE
2023 (235)

Does not contain REACH SVHC

Halogen Content

Not Low Halogen - contains Br or Cl > 900
ppm.

Solder Process Capability

Wave solder capable to 265°C

Product Compliance Disclaimer

This information is provided based on reasonable inquiry of our suppliers and represents our current actual knowledge based on the information they provided. This information is subject to change. The part numbers that TE has identified as EU RoHS compliant have a maximum concentration of 0.1% by weight in homogenous materials for lead, hexavalent chromium, mercury, PBB, PBDE, DBP, BBP, DEHP, DIBP, and 0.01% for cadmium, or qualify for an exemption to these limits as defined in the Annexes of Directive 2011/65/EU (RoHS2). Finished electrical and electronic equipment products will be CE marked as required by Directive 2011/65/EU. Components may not be CE marked. Additionally, the part numbers that TE has identified as EU ELV compliant have a maximum concentration of 0.1% by weight in homogenous materials for lead, hexavalent chromium, and mercury, and 0.01% for cadmium, or qualify for an exemption to these limits as defined in the Annexes of Directive 2000/53/EC (ELV). Regarding the REACH Regulation, the information TE provides on SVHC in articles for this part number is based on the latest European Chemicals Agency (ECHA) 'Guidance on requirements for substances in articles' posted at this URL: <https://echa.europa.eu/guidance-documents/guidance-on-reach>

Compatible Parts



Also in the Series | Dynamic 1000 Series

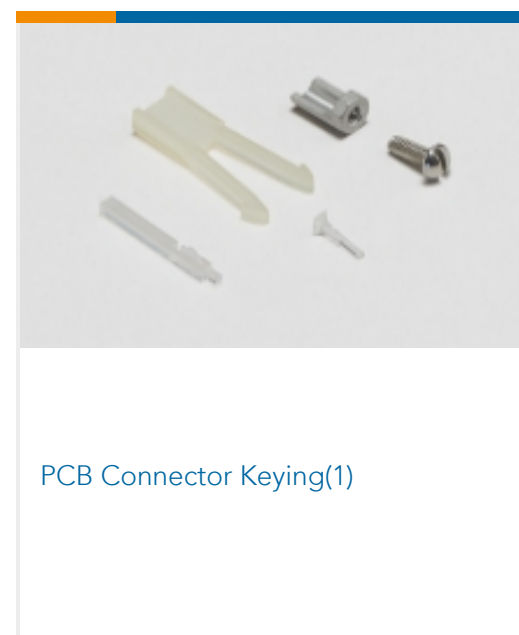
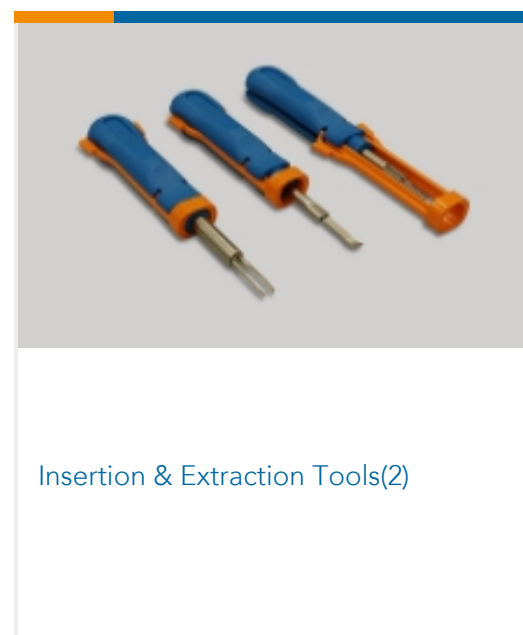
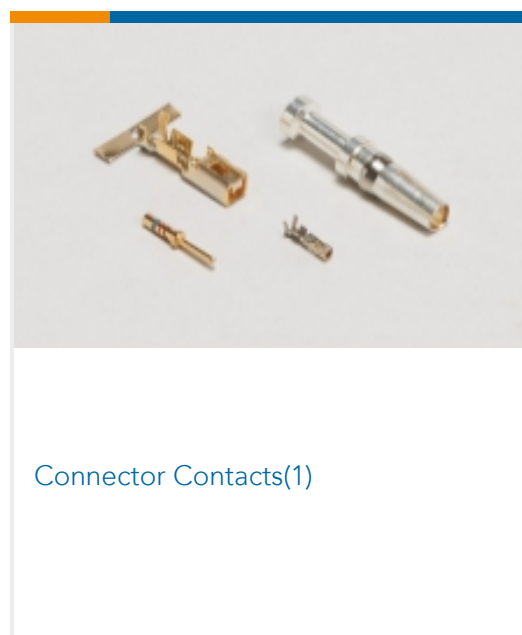

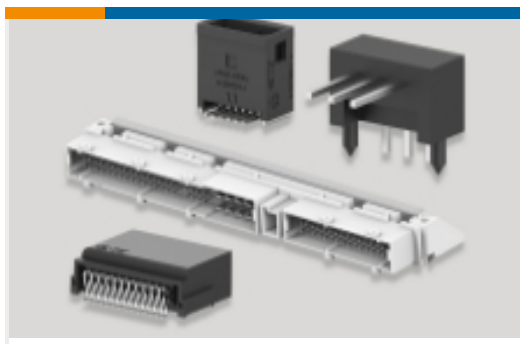

PCB Headers & Receptacles(173)



Rectangular Connector Housings(2)



Standard Rectangular Connectors(1)

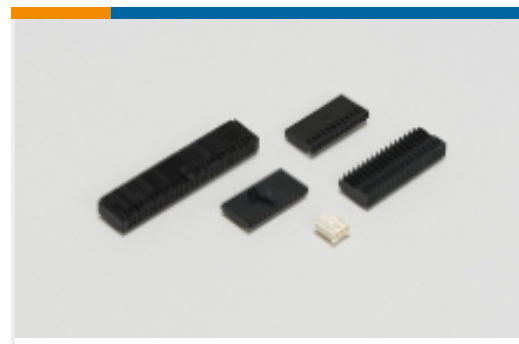

Wire-to-Board Connector Assemblies & Housings(157)



Wire-to-Board Connector Contacts(39)

Customers Also Bought



TE Part #1445715-4
75A HSG SUBASY GREEN



TE Part #1420011-3
GET CONNECTOR

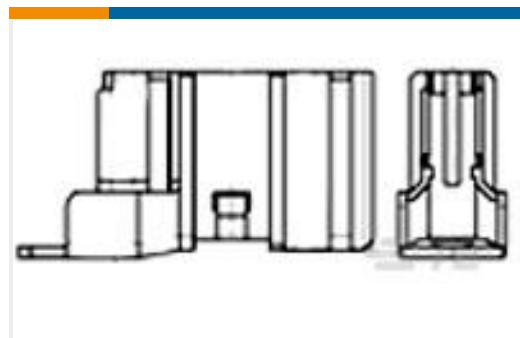

TE Part #927689-2
26P MOD4 ABDECKKAPP

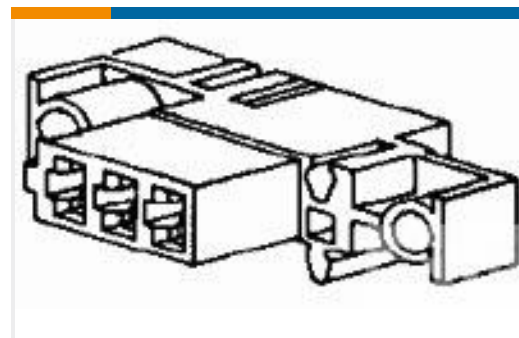

TE Part #1-480252-0
FF 187 REC HSG 3P NYLON NAT



TE Part #1-640387-1
11P MTA156 HDR ASSY SQ R/A



TE Part #926209-2
LOCKING CLIP HSG.

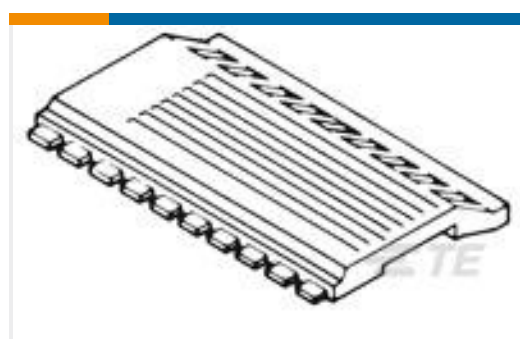

TE Part #1-102541-0
24 AMPMODU MT COVER DR .100CL



TE Part #1-640383-9
19P MTA156 HDR ASSY STR SQ SN

Documents

Product Drawings

[DYNAMIC 1900D HDR ASSY H-TYPE 8P](#)

English

CAD Files

[3D PDF](#)

[3D](#)

[Customer View Model](#)

[ENG_CVM_CVM_1-1871935-4_D_c-1-1871935-4-d.2d_dxf.zip](#)



English

Customer View Model

[ENG_CVM_CVM_1-1871935-4_D_c-1-1871935-4-d.3d_igs.zip](#)

English

Customer View Model

[ENG_CVM_CVM_1-1871935-4_D_c-1-1871935-4-d.3d_stp.zip](#)

English

By downloading the CAD file I accept and agree to the [Terms and Conditions](#) of use.

Datasheets & Catalog Pages

DYNAMIC SPRING CLAMP SERIES

English

DYNAMIC SPRING CLAMP SERIES

Japanese

[1-1773721-5_DYNAMIC_SERIES_QRG](#)

English

[1-1773732-4_DYNAMIC_SERIES_CATALOG_ENGLISH](#)

Japanese

[1-1773732-4_DYNAMIC_SERIES_CATALOG_ENGLISH](#)

English

Product Specifications

Product Specification

Japanese

Product Environmental Compliance

Product Compliance

English

Product Compliance

English

Agency Approvals

UL Report

English