

1-1825910-8 ✓ ACTIVE

Alcoswitch | Alcoswitch FSM

TE Internal #: 1-1825910-8

Tactile Switches, Round Actuator Style, NO, Brass, Silver, Low Profile, 50 mA, 24 VDC, Alcoswitch FSM

[View on TE.com >](#)



Relays, Contactors & Switches > Switches > Tactile Switches

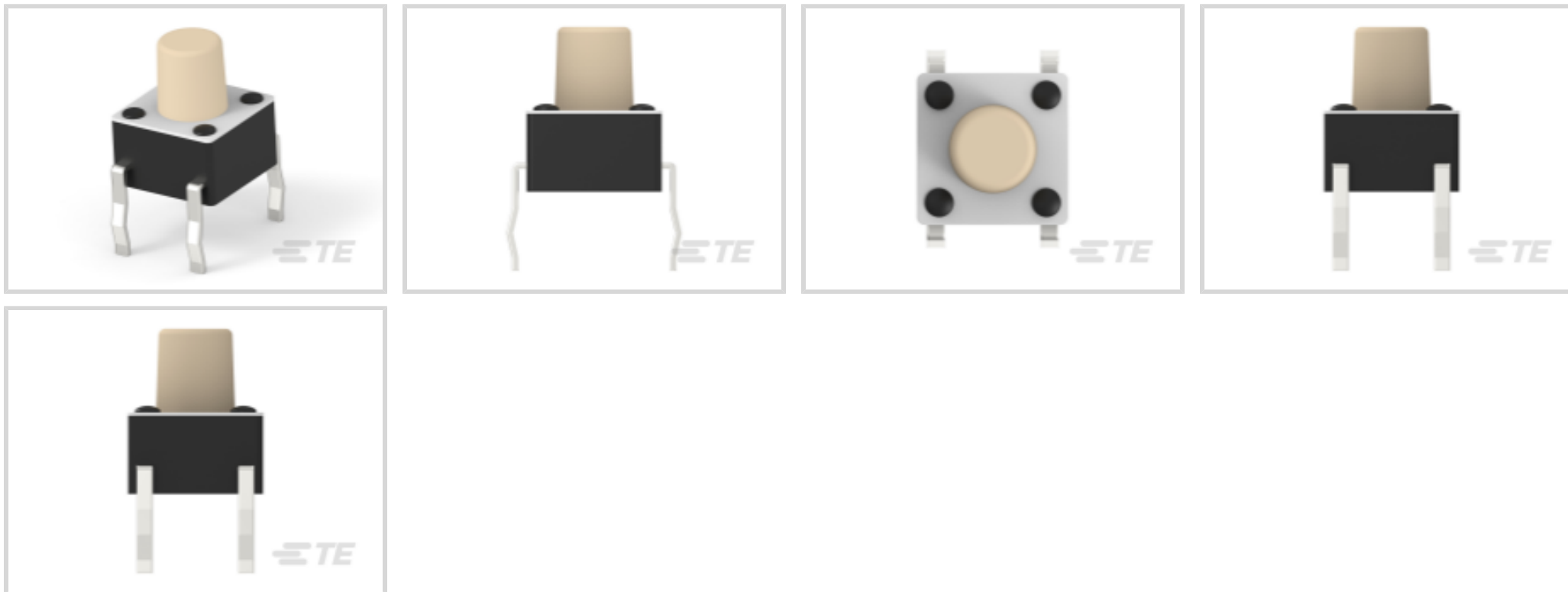

Actuator Style: **Round**

Operating Function: **NO**

Contact Base Material: **Brass**

Switch Contact Plating Material: **Silver**

Dust Proof: **No**

Features

Product Type Features

Product Type	Switch
Leg Style	Kinked
Illuminated	With
Actuator Style	Round
Dust Proof	No

Configuration Features

Tactile Feel	With
ESD Grounding Terminal	Without
Ganged	With
Tactile	Yes
Snap Action	Without
Operating Function	NO
Support Bracket	Without
Configuration (Pole-Throw)	Single Pole - Single Throw
Number of Actuators	Single



Electrical Characteristics

Tactile Switch Voltage Rating	24 VDC
-------------------------------	--------

Body Features

Cover Material	PET Film
Case Color	Black
Actuator Force	160 g[5.648 oz]
Case Material	Nylon
Bushing Style	Unthreaded
Actuator Profile	Extended
Actuator Material	Nylon
Actuator Color	Ivory

Contact Features

Contact Base Material	Brass
Switch Contact Plating Material	Silver
Tactile Switch Contact Current Rating	50 mA

Termination Features

Termination Type	Printed Circuit Board
------------------	-----------------------

Mechanical Attachment

Tactile Switch Mounting Type	Through Hole
Tactile Switch Mounting Angle	Vertical

Housing Features

Low Profile	With
Process Sealed	No

Dimensions

Actuator Length	3.7 mm[.146 in]
Button Width	3.3 mm[.13 in]
	.287 in

Usage Conditions

Temperature Rating	High °C
--------------------	---------

Packaging Features

Packaging Method	Loose Piece
------------------	-------------



Other

Comment	(On) indicates momentary position.
---------	------------------------------------

Product Compliance

[For compliance documentation, visit the product page on TE.com>](#)

EU RoHS Directive 2011/65/EU	Compliant
EU ELV Directive 2000/53/EC	Compliant
China RoHS 2 Directive MIIT Order No 32, 2016	No Restricted Materials Above Threshold
EU REACH Regulation (EC) No. 1907/2006	Current ECHA Candidate List: JUNE 2023 (235) Candidate List Declared Against: JUNE 2023 (235) Does not contain REACH SVHC
Halogen Content	Low Halogen - Br, Cl, F, I < 900 ppm per homogenous material. Also BFR/CFR/PVC Free
Solder Process Capability	Wave solder capable to 265°C

Product Compliance Disclaimer

This information is provided based on reasonable inquiry of our suppliers and represents our current actual knowledge based on the information they provided. This information is subject to change. The part numbers that TE has identified as EU RoHS compliant have a maximum concentration of 0.1% by weight in homogenous materials for lead, hexavalent chromium, mercury, PBB, PBDE, DBP, BBP, DEHP, DIBP, and 0.01% for cadmium, or qualify for an exemption to these limits as defined in the Annexes of Directive 2011/65/EU (RoHS2). Finished electrical and electronic equipment products will be CE marked as required by Directive 2011/65/EU. Components may not be CE marked. Additionally, the part numbers that TE has identified as EU ELV compliant have a maximum concentration of 0.1% by weight in homogenous materials for lead, hexavalent chromium, and mercury, and 0.01% for cadmium, or qualify for an exemption to these limits as defined in the Annexes of Directive 2000/53/EC (ELV). Regarding the REACH Regulation, the information TE provides on SVHC in articles for this part number is based on the latest European Chemicals Agency (ECHA) 'Guidance on requirements for substances in articles' posted at this URL: <https://echa.europa.eu/guidance-documents/guidance-on-reach>

Compatible Parts

 <p>TE Part # 1825910-6 FSM4JH=6MM TACT SWITCH, HIGH TEMP</p>	 <p>TE Part # 2-1825910-7 FSM14JH=6MM TACT SWITCH, HIGH TEMP</p>	 <p>TE Part # 4-1437565-2 FSM4JSMATR=TACT SWITCH 6X6MIL</p>	 <p>TE Part # 3-1437565-0 FSM2JSMATR=ON T/R</p>
--	---	--	--

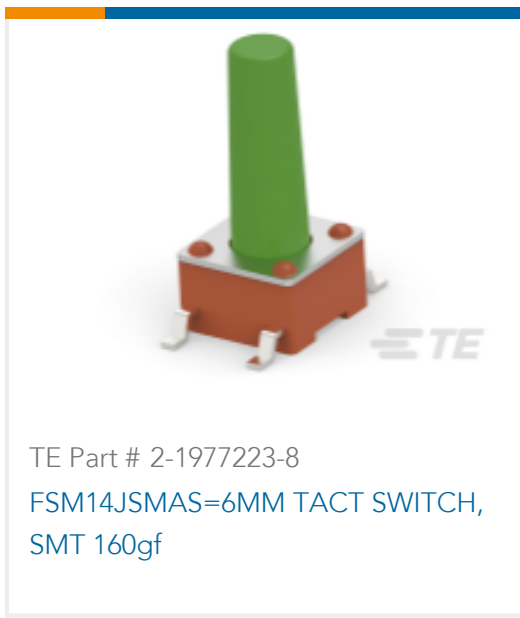

Also in the Series | Alcoswitch FSM

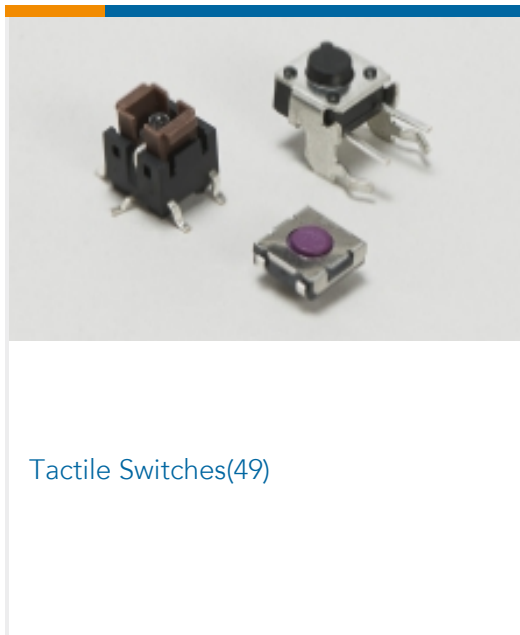

Customers Also Bought

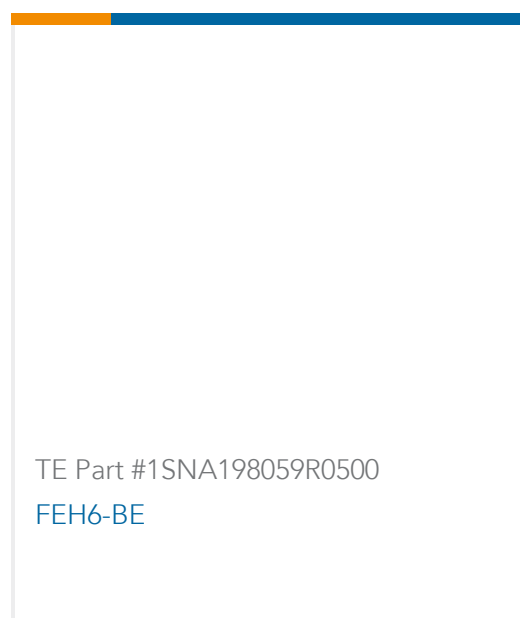
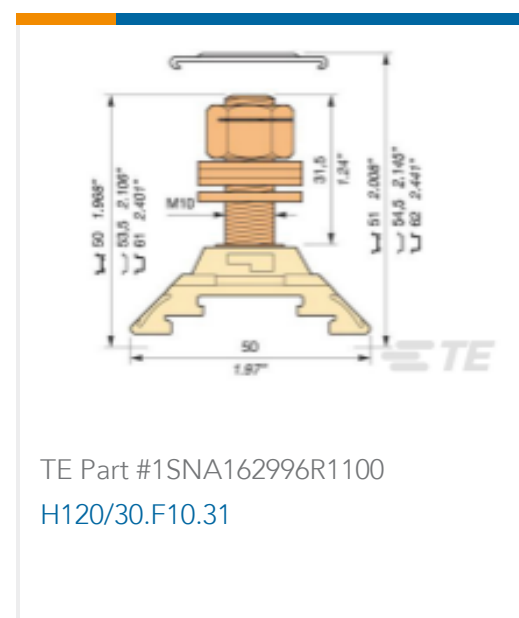
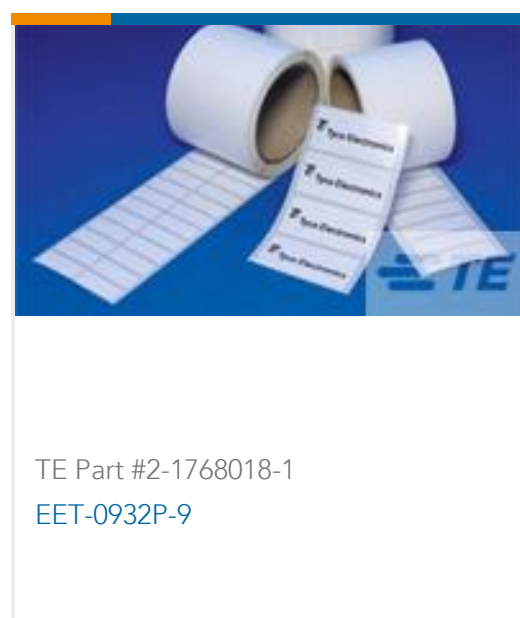
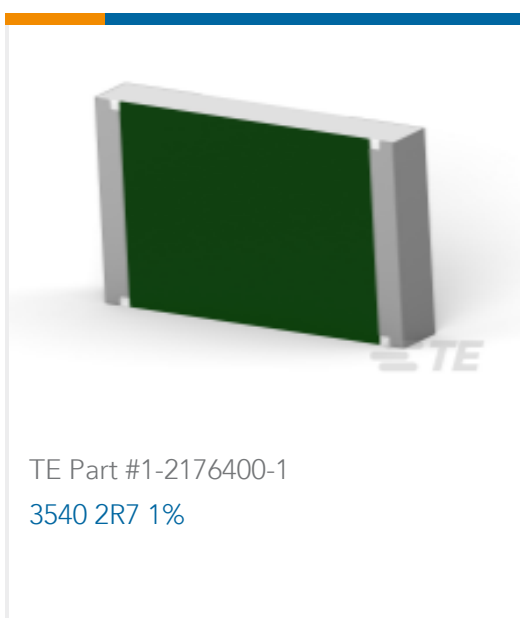
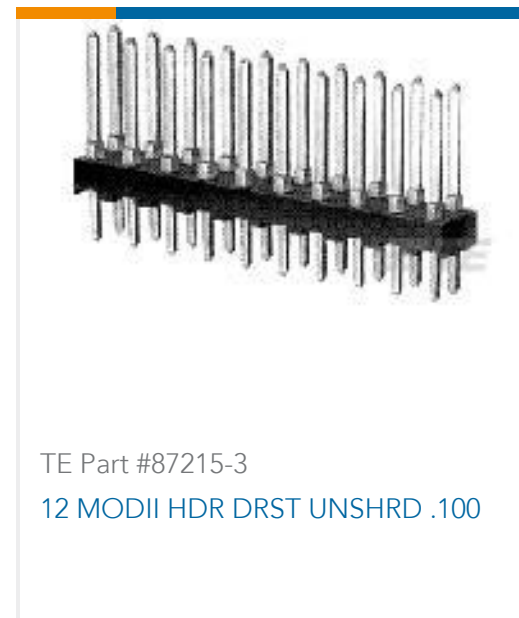



Documents

CAD Files

Customer View Model

[ENG_CVM_CVM_1-1825910-8_C.2d_dxf.zip](#)

English

3D PDF

3D

Customer View Model

[ENG_CVM_CVM_1-1825910-8_C.3d_igs.zip](#)

English

Customer View Model

[ENG_CVM_CVM_1-1825910-8_C.3d_stp.zip](#)

English

By downloading the CAD file I accept and agree to the [Terms and Conditions](#) of use.

Datasheets & Catalog Pages

[SWITCHES_CORE_PROGRAM_CATALOG](#)

English

Product Environmental Compliance

Product Compliance Document

English

Product Compliance Document

English