

1-174353-1 ✓ ACTIVE

AMP | Econoseal, Econoseal J - 070 Mark II

TE Internal #: 1-174353-1

Automotive Connector Locks & Position Assurance, TPA (Terminal Position Assurance), Natural, PBT, Econoseal J - 070 Mark II

[View on TE.com >](#)



Connectors > Automotive Connectors > Automotive Connector Accessories > Automotive Connector Locks & Position Assurance

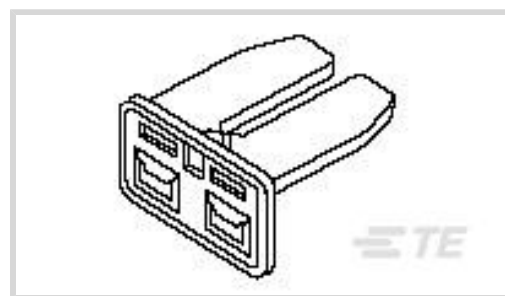

Connector & Contact Retention Accessory Type: **TPA (Terminal Position Assurance)**

Primary Product Color: **Natural**

Primary Product Material: **PBT**

Operating Temperature Range: **-30 – 105 °C [ -22 – 221 °F ]**

## Features

### Product Type Features

Connector & Contact Retention Accessory Type	TPA (Terminal Position Assurance)
--	-----------------------------------

### Body Features

Primary Product Color	Natural
Primary Product Material	PBT

### Usage Conditions

Operating Temperature Range	-30 – 105 °C [ -22 – 221 °F ]
-----------------------------	-------------------------------

### Industry Standards

UL Flammability Rating	UL 94HB
------------------------	---------

### Packaging Features

Packaging Quantity	1000
Packaging Method	Bag

### Other

Serviceable	Yes
-------------	-----

## Product Compliance

[For compliance documentation, visit the product page on TE.com>](#)

EU RoHS Directive 2011/65/EU	Compliant
EU ELV Directive 2000/53/EC	Compliant
China RoHS 2 Directive MIIT Order No 32, 2016	No Restricted Materials Above Threshold



EU REACH Regulation (EC) No. 1907/2006

Current ECHA Candidate List: JUNE 2023 (235)

Candidate List Declared Against: JUNE 2023 (235)

Does not contain REACH SVHC

Halogen Content

Low Halogen - Br, Cl, F, I < 900 ppm per homogenous material. Also BFR/CFR/PVC Free

Solder Process Capability

Not applicable for solder process capability

Product Compliance Disclaimer

This information is provided based on reasonable inquiry of our suppliers and represents our current actual knowledge based on the information they provided. This information is subject to change. The part numbers that TE has identified as EU RoHS compliant have a maximum concentration of 0.1% by weight in homogenous materials for lead, hexavalent chromium, mercury, PBB, PBDE, DBP, BBP, DEHP, DIBP, and 0.01% for cadmium, or qualify for an exemption to these limits as defined in the Annexes of Directive 2011/65/EU (RoHS2). Finished electrical and electronic equipment products will be CE marked as required by Directive 2011/65/EU. Components may not be CE marked. Additionally, the part numbers that TE has identified as EU ELV compliant have a maximum concentration of 0.1% by weight in homogenous materials for lead, hexavalent chromium, and mercury, and 0.01% for cadmium, or qualify for an exemption to these limits as defined in the Annexes of Directive 2000/53/EC (ELV). Regarding the REACH Regulation, the information TE provides on SVHC in articles for this part number is based on the latest European Chemicals Agency (ECHA) 'Guidance on requirements for substances in articles' posted at this URL: <https://echa.europa.eu/guidance-documents/guidance-on-reach>

## Compatible Parts



TE Part # CAT-EC7491-CH8172  
ECONOSEAL, CONNECTOR HOUSING



TE Part # 1-174355-1  
E-J MK-2 CAP HSG 2P NATURAL

## Also in the Series | Econoseal



Automotive Connector Caps & Covers (1)

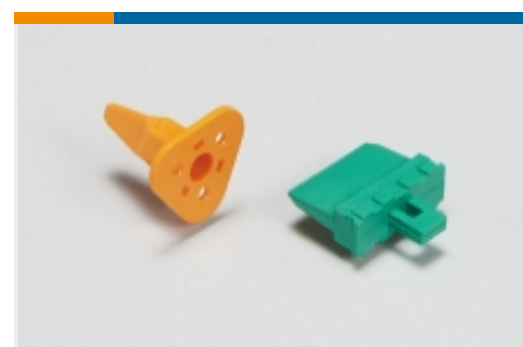

Automotive Connector Locks & Position Assurance(25)



Automotive Housings(105)



Automotive Terminals(48)

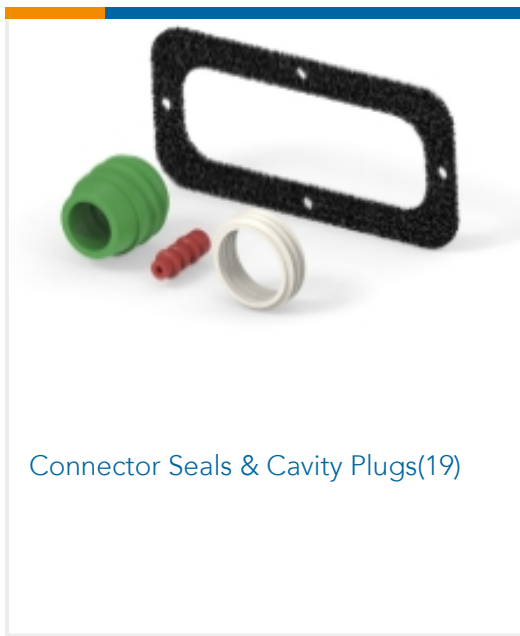

Connector Seals & Cavity Plugs(19)

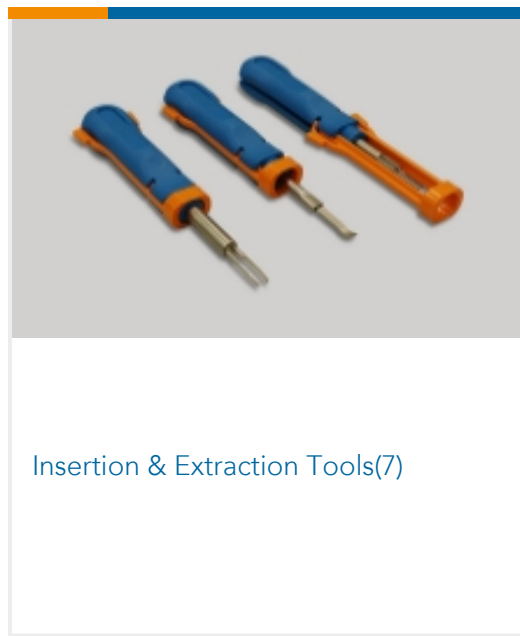

Insertion & Extraction Tools(7)

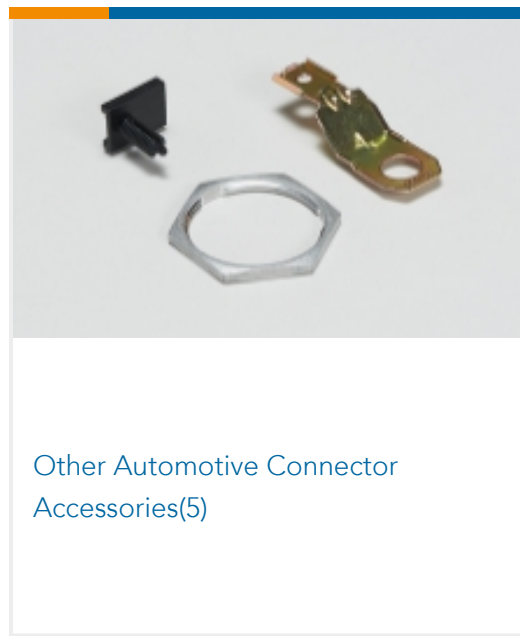

Other Automotive Connector Accessories(5)



PCB Headers & Receptacles(4)

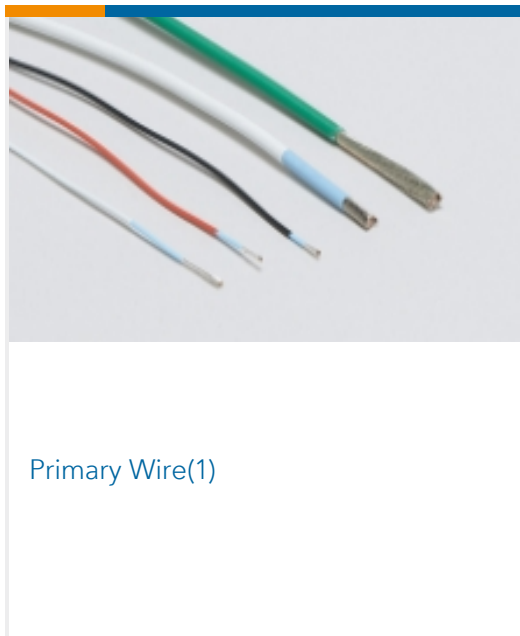

Primary Wire(1)

### Also in the Series | Econoseal J - 070 Mark II



Automotive Connector Locks & Position Assurance(8)

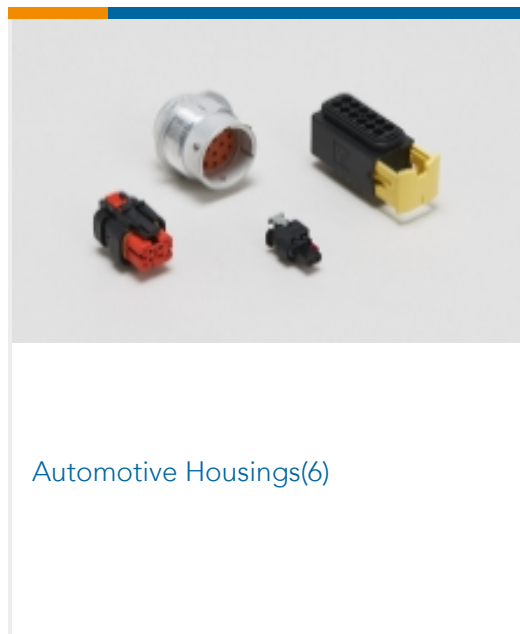

Automotive Housings(6)

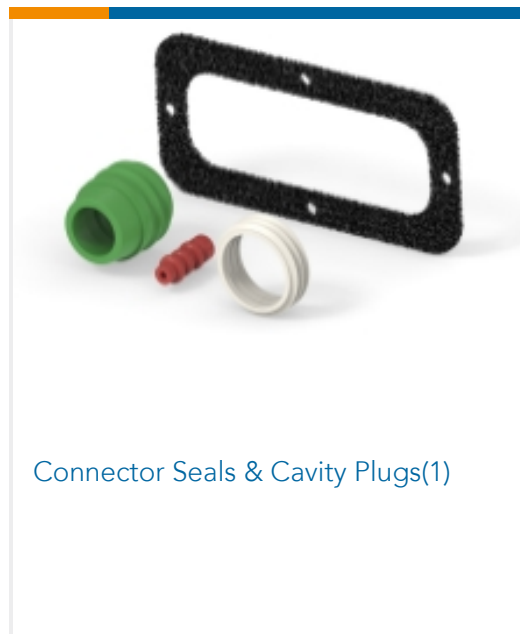

Connector Seals & Cavity Plugs(1)



PCB Headers & Receptacles(1)

### Customers Also Bought



TE Part #174359-2  
ECONOSEAL, CONNECTOR HOUSING



TE Part #3-1418483-1  
2POS,AMP MCP2.8,REC. HSG



TE Part #1011-332-0205  
DT BACKSHELL 180 2way recpt, NV 4.5



TE Part #1939556-4  
AMP SEAL16 2P CAP ASSY WITH RESIST 120



TE Part #172193-1  
ECONOSEAL-J CONN RUBBER 8P

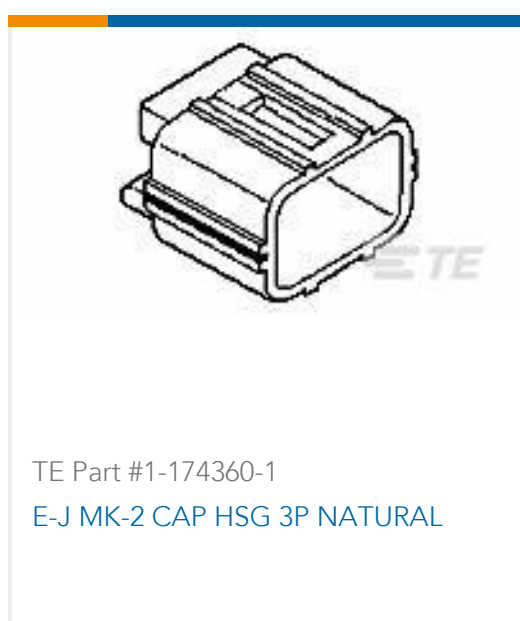

TE Part #1-174360-1  
E-J MK-2 CAP HSG 3P NATURAL



TE Part #2822354-1  
070 TYPE RUBBER PLUG

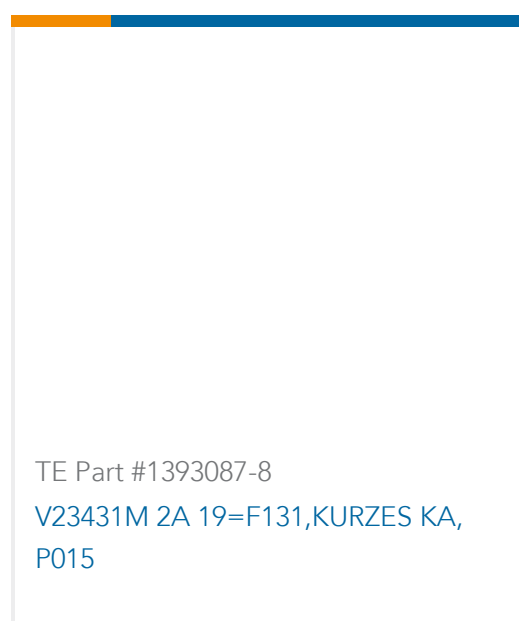

TE Part #1393087-8  
V23431M 2A 19=F131,KURZES KA, P015

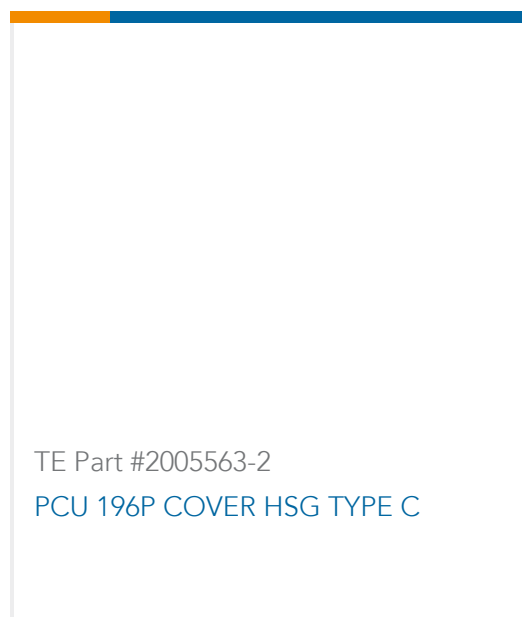

## Documents

### Product Drawings

[070 E-J MK2 PLATE 2P](#)

English

### CAD Files

Customer View Model

[ENG\\_CVM\\_1-174353-1\\_C.3d\\_igs.zip](#)

English

Customer View Model

[ENG\\_CVM\\_1-174353-1\\_C.3d\\_stp.zip](#)

English

Customer View Model

[ENG\\_CVM\\_1-174353-1\\_C.2d\\_dxf.zip](#)

English

[3D PDF](#)

English

By downloading the CAD file I accept and agree to the [Terms and Conditions](#) of use.

### Product Specifications

[Product Specification](#)

English

[Product Specification](#)

Japanese

### Instruction Sheets

[ECONOSEAL J MARK II+ CONNECTOR \(EJ-MK II+\)](#)

English

[Customer Manual \(non U.S.\)](#)

English

[ECONOSEAL J MARK II+ CONNECTOR](#)

English

[Customer Manual \(non U.S.\)](#)

English