

1-172165-2 ✓ ACTIVE

MATE-N-LOK | Mini-Universal MATE-N-LOK

TE Internal #: 1-172165-2

Rectangular Power Connectors, Housing, Plug, Wire-to-Wire, 2 Position, 4.2 mm [.165 in] Centerline, Wire & Cable, UL 94V-0, Mini-Universal MATE-N-LOK

[View on TE.com >](#)



Connectors > Power Connectors > Rectangular Power > Rectangular Power Connectors

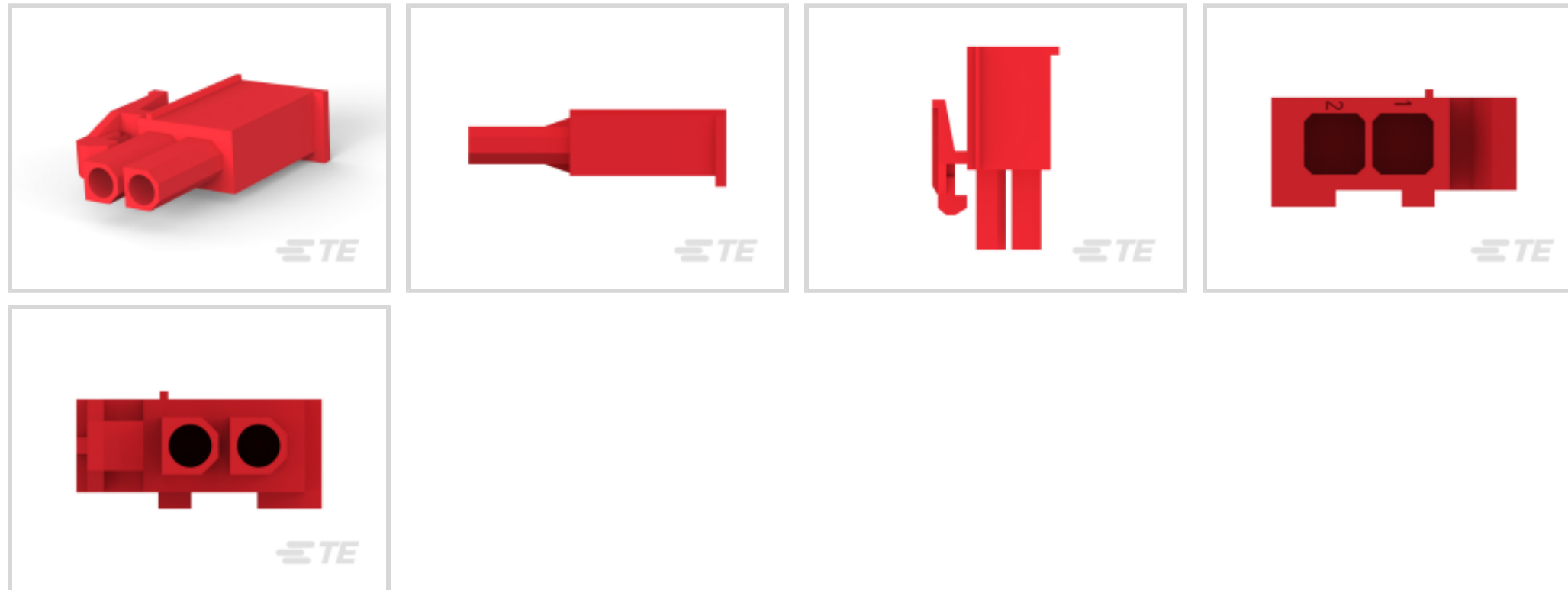

Rectangular Power Connector Type: **Housing**

Connector & Housing Type: **Plug**

Connector System: **Wire-to-Wire**

Number of Positions: **2**

Centerline (Pitch): **4.2 mm [.165 in]**

Features

Product Type Features

Rectangular Power Connector Type	Housing
Connector & Housing Type	Plug
Connector System	Wire-to-Wire
Sealable	No
Connector & Contact Terminates To	Wire & Cable

Configuration Features

Number of Positions	2
Number of Power Positions	0
Number of Signal Positions	0
Number of Rows	1

Electrical Characteristics

Operating Voltage	600 VDC
-------------------	---------

Contact Features

Multiple Contact Types	Without
------------------------	---------



Contact Layout	Inline
Contact Retention Within Housing	Without
Contact Type	Socket
Termination Features	
Termination Method to Wire & Cable	Crimp
Mechanical Attachment	
Panel Mount Feature	Without
Connector Mounting Type	Cable Mount (Free-Hanging)
Housing Features	
Centerline (Pitch)	4.2 mm [.165 in]
Housing Color	Red
Housing Material	Nylon 66
Dimensions	
Product Width	10.8 mm
Product Length	23.7 mm
Usage Conditions	
Operating Temperature Range	-20 – 105 °C [-4 – 221 °F]
Operation/Application	
Circuit Application	Power & Signal
Identification Marking	
Circuit Identification Feature	With
Industry Standards	
CSA Rating	Certified, LR 7189
UL Rating	Recognized
Agency/Standard	CSA, UL
Approved Standards	UL E28476
UL Flammability Rating	UL 94V-0
Glow Wire Rating	Standard Part - Not Glow Wire
Packaging Features	
Packaging Quantity	1000
Packaging Method	Bag



Product Compliance

[For compliance documentation, visit the product page on TE.com>](#)

EU RoHS Directive 2011/65/EU	Compliant
EU ELV Directive 2000/53/EC	Compliant
China RoHS 2 Directive MIIT Order No 32, 2016	No Restricted Materials Above Threshold
EU REACH Regulation (EC) No. 1907/2006	Current ECHA Candidate List: JUNE 2023 (235) Candidate List Declared Against: JUNE 2023 (235) SVHC > Threshold: Melamine (3% in Component Part) Article Safe Usage Statements: Wash thoroughly after handling. Do not handle until all safety precautions have been read and understood. Recycle if possible and dispose of the article by following all applicable governmental regulations relevant to your geographic location.
Halogen Content	Low Halogen - Br, Cl, F, I < 900 ppm per homogenous material. Also BFR/CFR/PVC Free
Solder Process Capability	Not applicable for solder process capability







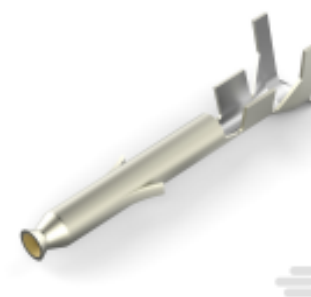









Product Compliance Disclaimer

This information is provided based on reasonable inquiry of our suppliers and represents our current actual knowledge based on the information they provided. This information is subject to change. The part numbers that TE has identified as EU RoHS compliant have a maximum concentration of 0.1% by weight in homogenous materials for lead, hexavalent chromium, mercury, PBB, PBDE, DBP, BBP, DEHP, DIBP, and 0.01% for cadmium, or qualify for an exemption to these limits as defined in the Annexes of Directive 2011/65/EU (RoHS2). Finished electrical and electronic equipment products will be CE marked as required by Directive 2011/65/EU. Components may not be CE marked. Additionally, the part numbers that TE has identified as EU ELV compliant have a maximum concentration of 0.1% by weight in homogenous materials for lead, hexavalent chromium, and mercury, and 0.01% for cadmium, or qualify for an exemption to these limits as defined in the Annexes of Directive 2000/53/EC (ELV). Regarding the REACH Regulation, the information TE provides on SVHC in articles for this part number is based on the latest European Chemicals Agency (ECHA) 'Guidance on requirements for substances in articles' posted at this URL: <https://echa.europa.eu/guidance-documents/guidance-on-reach>





Compatible Parts

 <p>TE Part # 1-770988-1 MINI UMNL SOK 22-18AWG LP LF</p>	 <p>TE Part # 1-770985-0 MINI UMNL PIN 26-22AWG AU LP</p>	 <p>TE Part # 1-770987-0 MINI UMNL PIN 22-18 AWG AU LP</p>	 <p>TE Part # 770988-3 MINI UMNL SOK 22-18AWG AU LP</p>
--	--	---	--



 <p>TE Part # 1-770988-0 MINI UMNL SOK 22-18AWG AU</p>	 <p>TE Part # 1-794059-0 MINI UMNL PIN L/P LF</p>	 <p>TE Part # 770988-1 MINI UMNL SOK 22-18AWG SN LP</p>	 <p>TE Part # 770986-1 MINI UMNL SOK 26-22AWG SN LP</p>
 <p>TE Part # 794058-1 MINI UMNL SOK L/P</p>	 <p>TE Part # 170365-3 MINI UNIVERSAL M-N-L SOCKET LP</p>	 <p>TE Part # 170364-3 MINI UNIVERSAL M-N-L PIN LP</p>	 <p>TE Part # 770985-1 MINI UMNL PIN 26-22AWG SN LP</p>
 <p>TE Part # 1-794407-1 MINI UMNL SOK 20-16 AWG AU LF</p>	 <p>TE Part # 171638-1 MINI U-M-N-L PIN CONT. LP</p>	 <p>TE Part # 171639-1 MINI U-M-N-L SOCKET LP</p>	 <p>TE Part # 770903-3 MINI UMNL PIN 22-18 AWG AU</p>
 <p>TE Part # 170366-3 MINI UNIVERSAL M-N-L SOCKET LP</p>	 <p>TE Part # 794059-1 MINI UMNL PIN L/P</p>	 <p>TE Part # 170364-1 MINI UNIVERSAL M-N-L PIN LP</p>	 <p>TE Part # 1-770902-1 MINI UMNL SOK 26-22 AWG AU LF</p>

Also in the Series | Mini-Universal MATE-N-LOK

 <p>Connector Contacts(8)</p>	 <p>Connector Seals & Cavity Plugs(17)</p>	 <p>Connector Strain Relief(4)</p>	 <p>Insertion & Extraction Tools(1)</p>
--	--	---	--



PCB Headers & Receptacles(1)

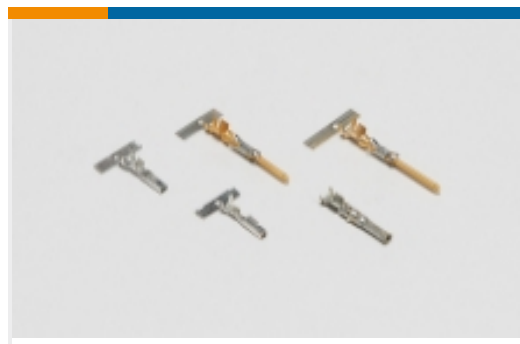

Power Contacts(84)



Rectangular Connector Keying Plugs(2)



Rectangular Connector Locking(2)



Rectangular Power Connectors(244)

Customers Also Bought

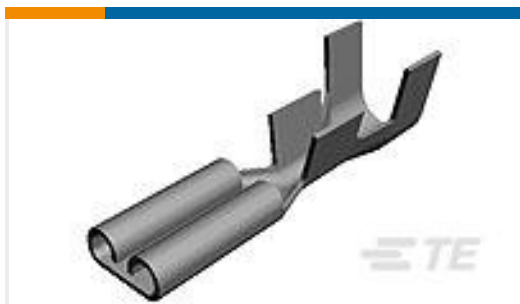

TE Part #41274-1
250 FASTON,REC.,18-14 AWG,TPBR

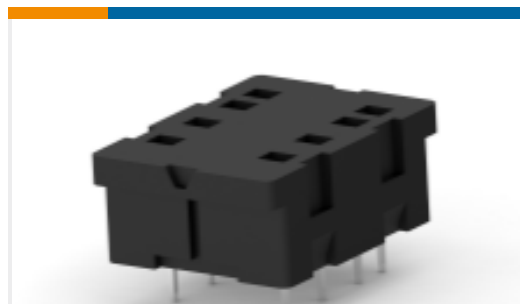

TE Part #5-1415043-1
PT78602



TE Part #9-1879336-1
CPF 0603 2K0 1% 50PPM 1K RL



TE Part #2-292254-2
CT RELAY HDR ASSY 2P BLUE

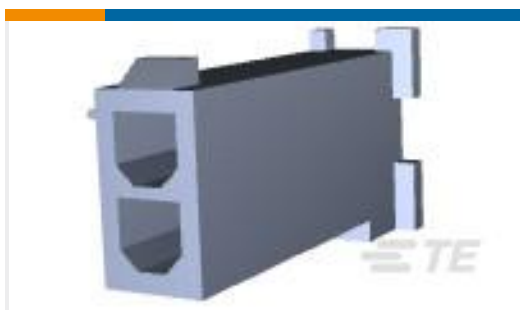

TE Part #1-172233-9
2P MINI UNIV FREE HANG BLACK



TE Part #1-172165-6
2CIR MINI U-M-N-L PLUG BLUE



TE Part #1-2314876-0
10P,2MM,B-B,REC,SRVT,2,7,0.1AU,TB

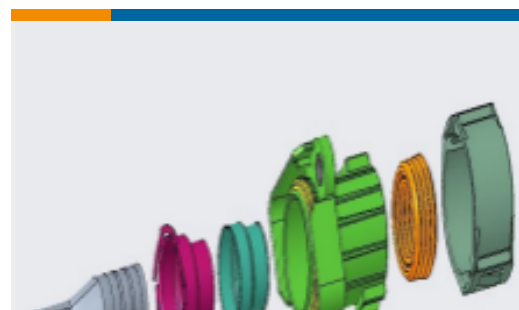

TE Part #YIPT-1PXI-70MM-000
IPT-1pxi 70sqmm

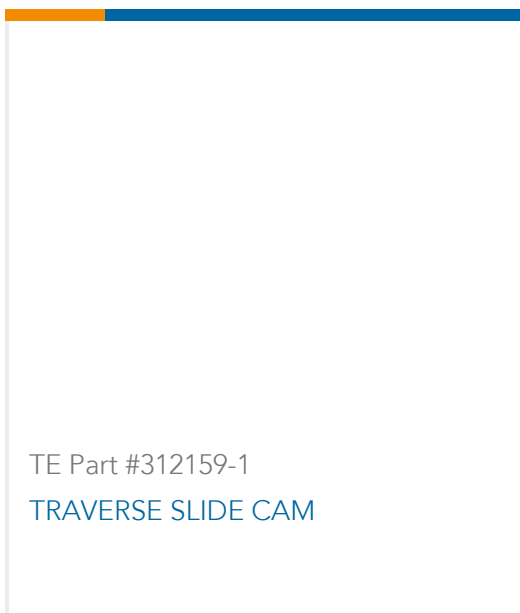

TE Part #312159-1
TRAVERSE SLIDE CAM

Documents



Product Drawings

2CIR MINI U-M-N-L PLUG RED

English

CAD Files

3D PDF

3D

Customer View Model

[ENG_CVM_CVM_1-172165-2_H.2d_dxf.zip](#)

English

Customer View Model

[ENG_CVM_CVM_1-172165-2_H.3d_igs.zip](#)

English

Customer View Model

[ENG_CVM_CVM_1-172165-2_H.3d_stp.zip](#)

English

By downloading the CAD file I accept and agree to the [Terms and Conditions](#) of use.

Product Specifications

Engineering Report

English

Product Environmental Compliance

[MD_1-172165-2_042120162349_dmtec](#)

English

[MD_1-172165-2_042120162349_dmtec](#)

English

Instruction Sheets

Instruction Sheet (U.S.)

English