

1-170823-3 ✓ ACTIVE

FASTON | FASTON 187

TE Internal #: 1-170823-3

Crimp Terminal Housings, Receptacle, Receptacle, 1 Position,
Straight, UL 94V-2, Natural, Soft PVC, -40 – 105 °C [-40 – 221 °F],
FASTON 187

[View on TE.com >](#)



Terminals & Splices > Terminal Housings, Insulation Sleeves & Blocks > Crimp Terminal Housings



Terminal Type: **Receptacle**

Connector & Housing Type: **Receptacle**

Number of Positions: **1**

Terminal Orientation: **Straight**

UL Flammability Rating: **UL 94V-2**

Features

Product Type Features

Sealable	No
Connector & Housing Type	Receptacle

Configuration Features

Number of Positions	1
---------------------	---

Body Features

Primary Product Color	Natural
-----------------------	---------

Contact Features

Terminal Type	Receptacle
Terminal Orientation	Straight
Contact Mating Retention	Without

Mechanical Attachment

Mating Alignment	Without
------------------	---------

Housing Features

--	--



Housing Material	Soft PVC
------------------	----------

Dimensions

Product Length	23 mm[.906 in]
Compatible Insulation Diameter Range	1.8 mm[.071 in]

Usage Conditions

Operating Temperature Range	-40 – 105 °C[-40 – 221 °F]
-----------------------------	----------------------------

Industry Standards

UL Flammability Rating	UL 94V-2
------------------------	----------

Product Compliance

[For compliance documentation, visit the product page on TE.com>](#)

















EU RoHS Directive 2011/65/EU	Compliant
EU ELV Directive 2000/53/EC	Compliant
China RoHS 2 Directive MIIT Order No 32, 2016	No Restricted Materials Above Threshold
EU REACH Regulation (EC) No. 1907/2006	Current ECHA Candidate List: JUNE 2023 (235) Candidate List Declared Against: JUNE 2023 (235) SVHC > Threshold: Dioctyltin dilaurate derivs (.3% in Component Part)
Halogen Content	Not Low Halogen - contains Br or Cl > 900 ppm.
Solder Process Capability	Not applicable for solder process capability

Product Compliance Disclaimer

This information is provided based on reasonable inquiry of our suppliers and represents our current actual knowledge based on the information they provided. This information is subject to change. The part numbers that TE has identified as EU RoHS compliant have a maximum concentration of 0.1% by weight in homogenous materials for lead, hexavalent chromium, mercury, PBB, PBDE, DBP, BBP, DEHP, DIBP, and 0.01% for cadmium, or qualify for an exemption to these limits as defined in the Annexes of Directive 2011/65/EU (RoHS2). Finished electrical and electronic equipment products will be CE marked as required by Directive 2011/65/EU. Components may not be CE marked. Additionally, the part numbers that TE has identified as EU ELV compliant have a maximum concentration of 0.1% by weight in homogenous materials for lead, hexavalent chromium, and mercury, and 0.01% for cadmium, or qualify for an exemption to these limits as defined in the Annexes of Directive 2000/53/EC (ELV). Regarding the REACH Regulation, the information TE provides on SVHC in articles for this part number is based on the latest European Chemicals Agency (ECHA) 'Guidance on requirements for substances in articles' posted at this URL: <https://echa.europa.eu/guidance-documents/guidance-on-reach>

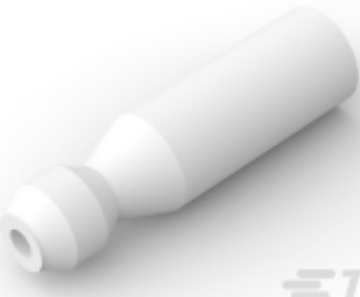
Compatible Parts



 <p>TE Part # 170823-1 110 FASTON SLEEVE,TAB, TRANSPARENT,NAT</p>	 <p>TE Part # 170891-2 250 FASTON HSG.,FLAG,REC., NATRUAL</p>	 <p>TE Part # 1-170823-9 250 FASTON SLEEVE,REC., TRANSPARENT,NAT</p>	 <p>TE Part # 170823-4 250 FASTON SLEEVE,REC., TRANSPARENT</p>
 <p>TE Part # 1-170823-4 187 FASTON SLEEVE,REC., TRANSPARENT,NAT</p>	 <p>TE Part # 1-170823-5 250 FASTON SLEEVE,REC., TRANSPARENT</p>	 <p>TE Part # 170823-3 250 FASTON SLEEVE,REC., TRANSPARENT</p>	 <p>TE Part # 170823-2 250 FASTON SLEEVE,REC., TRANSPARENT</p>
 <p>TE Part # 170891-1 250 FASTON HSG.,FLAG,REC., NATRUAL</p>	 <p>TE Part # 170823-6 250 FASTON SLEEVE,REC., TRANSPARENT</p>	 <p>TE Part # 170892-4 187 FASTON HSG.,REC.,NATRUAL</p>	 <p>TE Part # 170892-1 187 FASTON HSG.,REC.,NATRUAL</p>
 <p>TE Part # 1-170823-6 250 FASTON SLEEVE,REC., TRANSPARENT</p>	 <p>TE Part # 1-170823-1 110 FASTON SLEEVE,REC., TRANSPARENT,NAT</p>	 <p>TE Part # 1-170823-8 250 FASTON SLEEVE,REC., TRANSPARENT</p>	 <p>TE Part # 170823-9 110 FASTON SLEEVE,REC., TRANSPARENT,NAT</p>
 <p>TE Part # 170889-4 SLEEVE DIA5 SHUR PLUG NAT</p>	 <p>TE Part # 170892-2 187 FASTON HSG.,REC.,NATRUAL</p>	 <p>TE Part # 2-170823-8 187 FASTON SLEEVE,FLAG,REC., TRANSPARENT</p>	 <p>TE Part # 4-170823-1 205 FASTON SLEEVE,REC.,NATRUAL</p>

Also in the Series | **FASTON 187**



Crimp Terminal Housings(42)



Insertion & Extraction Tools(1)

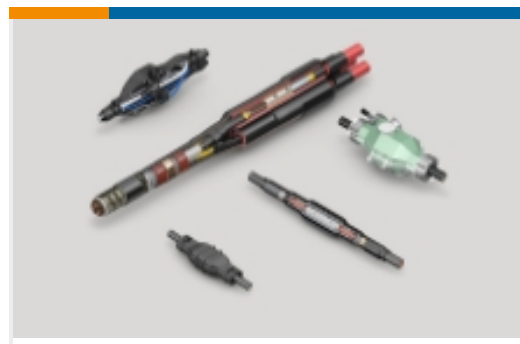

Joints & Splices(1)



PCB Terminals(42)



Quick Disconnects(209)



Splices(1)

Customers Also Bought

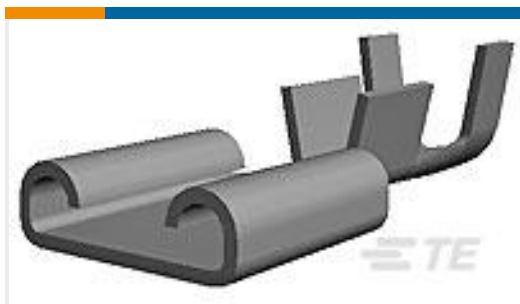

TE Part #170187-2
250 FASTON,REC.,22-18 AWG,TPBR



TE Part #42214-2
250 FASTON TAB TPBR



TE Part #170203-2
187 FASTON,REC.,24-20 AWG,TPBR

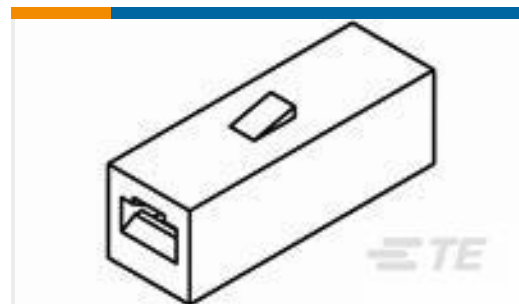

TE Part #626062
FASTIN-ON HOUSING REC PA66 NATURAL



TE Part #160655-4
FF 110 REC TERMINAL 20-15 AWG PTPPB

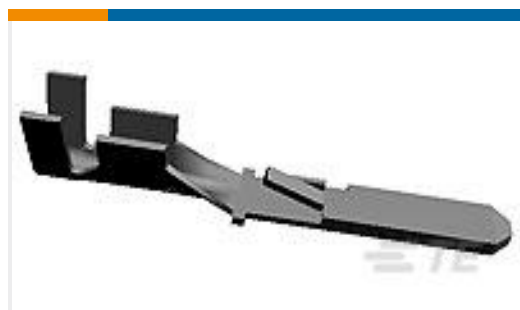

TE Part #160887-4
FF 110 TAB 0.5-1.0MM2 PTPPB



TE Part #NB19832001
RNF-100-3/32-YO-STK



TE Part #170892-4
187 FASTON HSG.,REC.,NATURAL



TE Part #2382224-1
EP 2.5 RCPT CONTACT, 26-22 AWG, Low IF



TE Part #1746825-1
ATAC CONN TERMINAL INSERT 3P

Documents



Product Drawings

[187 FASTON SLEEVE,REC.,TRANSPARENT,NAT](#)

English

CAD Files

[3D PDF](#)

3D

Customer View Model

[ENG_CVM_CVM_1-170823-3_F.2d_dxf.zip](#)

English

Customer View Model

[ENG_CVM_CVM_1-170823-3_F.3d_igs.zip](#)

English

Customer View Model

[ENG_CVM_CVM_1-170823-3_F.3d_stp.zip](#)

English

By downloading the CAD file I accept and agree to the [Terms and Conditions](#) of use.

Datasheets & Catalog Pages

[FASTON Housings](#)

English

Product Environmental Compliance

[MD_1-170823-3_01042018125_dmtec](#)

English

[MD_1-170823-3_01042018125_dmtec](#)

English