



AMP | MCON Interconnection System

TE Internal #: 1-1703498-1

Housing for Male Terminals, Wire-to-Wire, 2 Position, .157 in [4 mm] Centerline, Sealable, Black, Wire & Cable, Power, MCON Interconnection System

[View on TE.com >](#)

Connectors > Automotive Connectors > Automotive Housings



Connector System: **Wire-to-Wire**

Number of Positions: **2**

Connector & Housing Type: **Housing for Male Terminals**

Centerline (Pitch): **4 mm [.157 in]**

Sealable: **Yes**

Features

Product Type Features

Mixed & Hybrid Connector	No
Connector Shape	Rectangular
Connector System	Wire-to-Wire
Connector & Housing Type	Housing for Male Terminals
Sealable	Yes
Connector & Contact Terminates To	Wire & Cable
Primary Locking Feature	On the Terminal

Configuration Features

Number of Positions	2
Number of Rows	1

Electrical Characteristics

Operating Voltage	14 VDC
Nominal Voltage Architecture	12 V

Body Features

Cable Exit Angle	180°
Primary Product Color	Black
Connector & Keying Code	A

Contact Features



Contact Size	1.2mm
Contact Type	Tab
Contact Current Rating (Max)	25 A

Mechanical Attachment

Terminal Position Assurance	Yes
Strain Relief	Without
Mating Alignment Type	Keyed
Mating Alignment	With
Connector Mounting Type	Cable Mount (Free-Hanging)

Housing Features

Housing Material	PBT GF
Centerline (Pitch)	4 mm [.157 in]

Dimensions

Connector Height	14.95 mm [.589 in]
Product Width	44 mm [1.732 in]
Product Length	14.8 mm [.583 in]

Usage Conditions

Operating Temperature (Max)	130 °C [266 °F]
Operating Temperature Range	-40 – 130 °C [-40 – 266 °F]

Operation/Application

Circuit Application	Power
---------------------	-------

Packaging Features

Packaging Quantity	1500
Packaging Method	Box

Other

Serviceable	Yes
Connector Position Assurance Capable	No

Product Compliance

For compliance documentation, visit the product page on [TE.com](https://www.te.com)>

EU RoHS Directive 2011/65/EU	Compliant
EU ELV Directive 2000/53/EC	Compliant







China RoHS 2 Directive MIIT Order No 32, 2016	No Restricted Materials Above Threshold
EU REACH Regulation (EC) No. 1907/2006	Current ECHA Candidate List: JUNE 2023 (235) Candidate List Declared Against: JUNE 2023 (235) Does not contain REACH SVHC
Halogen Content	BFR/CFR/PVC Free, but Br/Cl >900 ppm in other sources.
Solder Process Capability	Not applicable for solder process capability

Product Compliance Disclaimer

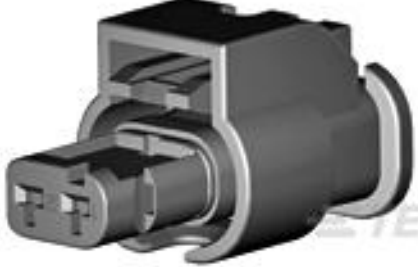
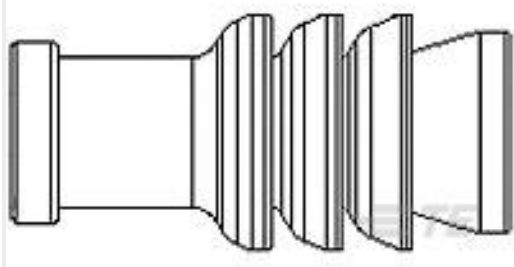
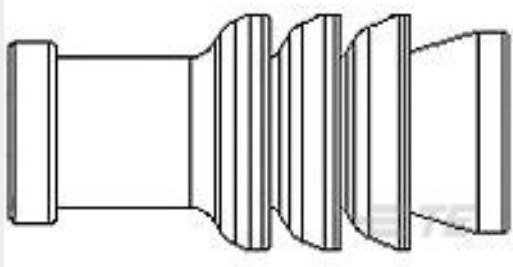
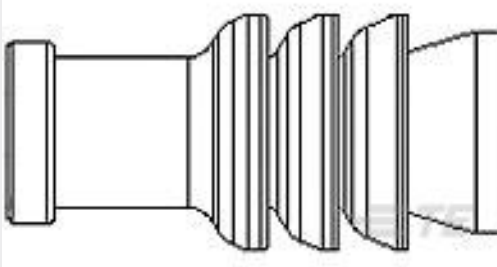
This information is provided based on reasonable inquiry of our suppliers and represents our current actual knowledge based on the information they provided. This information is subject to change. The part numbers that TE has identified as EU RoHS compliant have a maximum concentration of 0.1% by weight in homogenous materials for lead, hexavalent chromium, mercury, PBB, PBDE, DBP, BBP, DEHP, DIBP, and 0.01% for cadmium, or qualify for an exemption to these limits as defined in the Annexes of Directive 2011/65/EU (RoHS2). Finished electrical and electronic equipment products will be CE marked as required by Directive 2011/65/EU. Components may not be CE marked. Additionally, the part numbers that TE has identified as EU ELV compliant have a maximum concentration of 0.1% by weight in homogenous materials for lead, hexavalent chromium, and mercury, and 0.01% for cadmium, or qualify for an exemption to these limits as defined in the Annexes of Directive 2000/53/EC (ELV). Regarding the REACH Regulation, the information TE provides on SVHC in articles for this part number is based on the latest European Chemicals Agency (ECHA) 'Guidance on requirements for substances in articles' posted at this URL: <https://echa.europa.eu/guidance-documents/guidance-on-reach>

Compatible Parts

 <p>TE Part # 1-1670916-1 2POS, MCON 1.2 LL REC SEALED</p>	 <p>TE Part # 967056-1 MQS BLINDSTOPFEN4MM</p>	 <p>TE Part # 967067-1 MQS SGL WIRE SEAL</p>	 <p>TE Part # 967067-2 MQS EINZELLEITDICHT</p>
 <p>TE Part # CAT-M4595-T273 MCON Receptacle and Tab</p>	 <p>TE Part # 3-1579028-8 EXTRACTION TOOL</p>	 <p>TE Part # 1-1579028-5 INSERTION TOOL</p>	 <p>TE Part # 1-1718643-4 2POS, MCON 1.2 LL REC SEALED</p>



Also in the Series | MCON Interconnection System

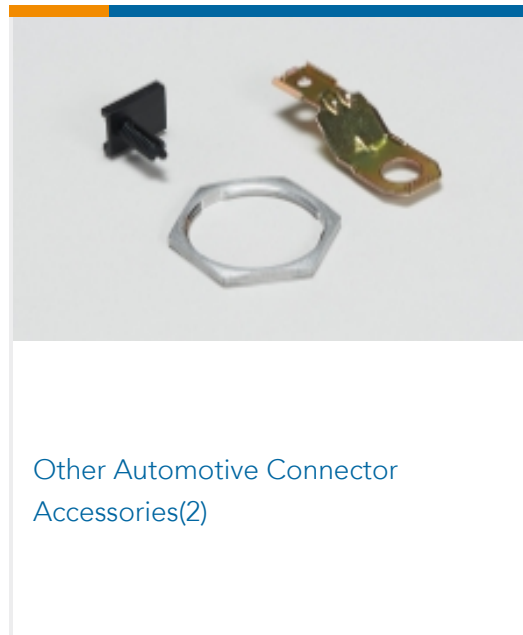
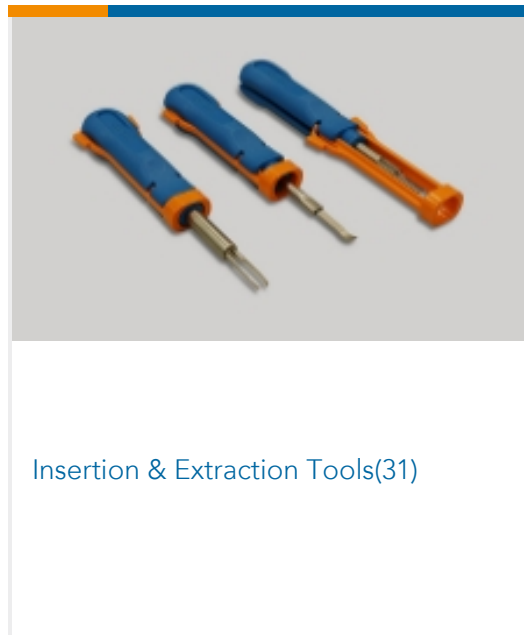
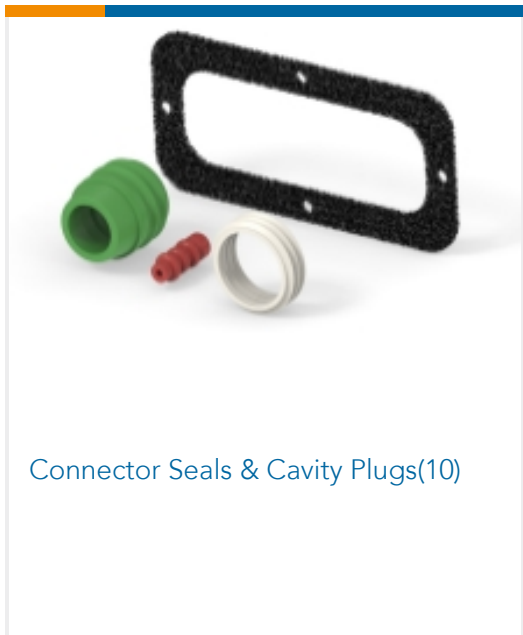
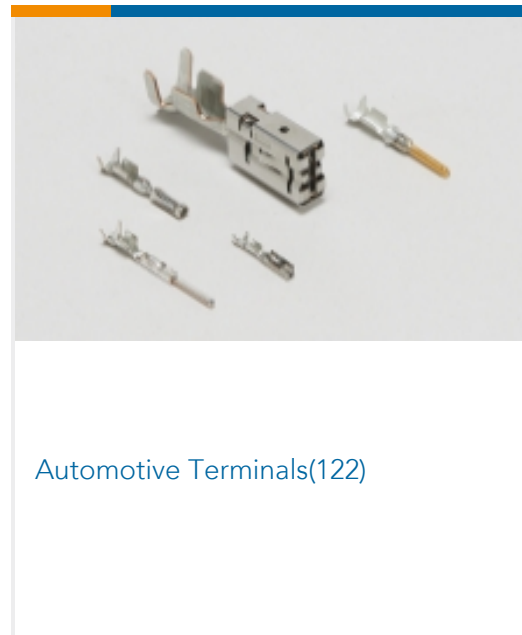
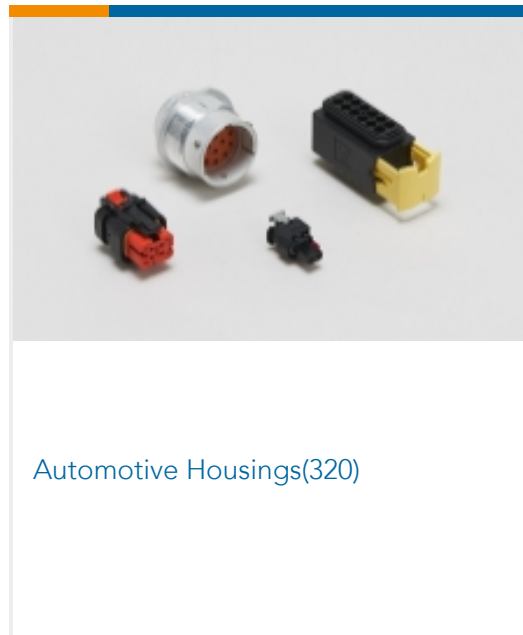
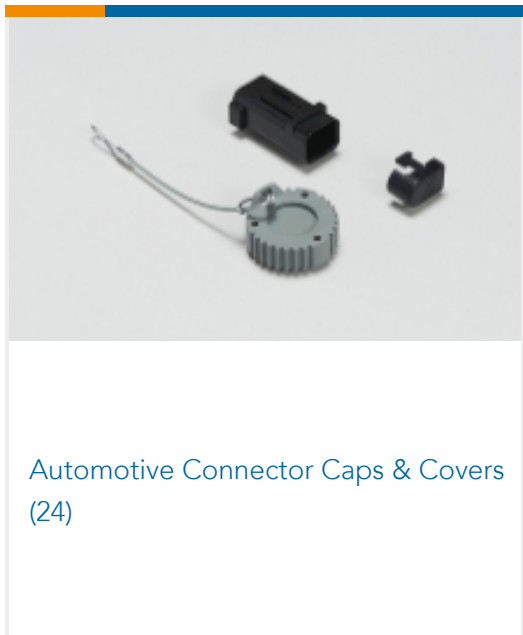

Customers Also Bought

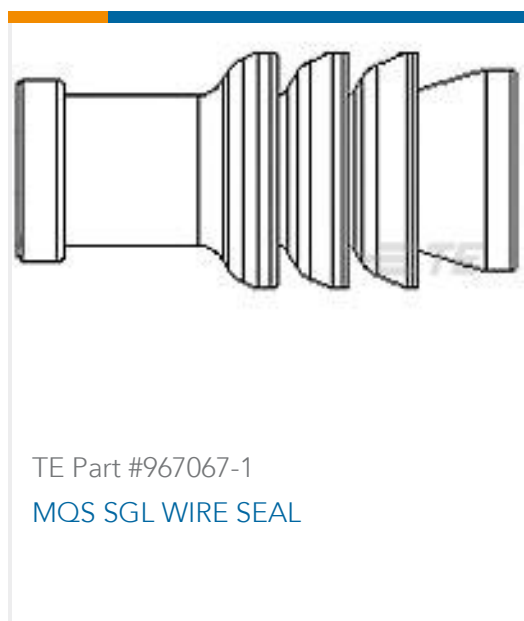

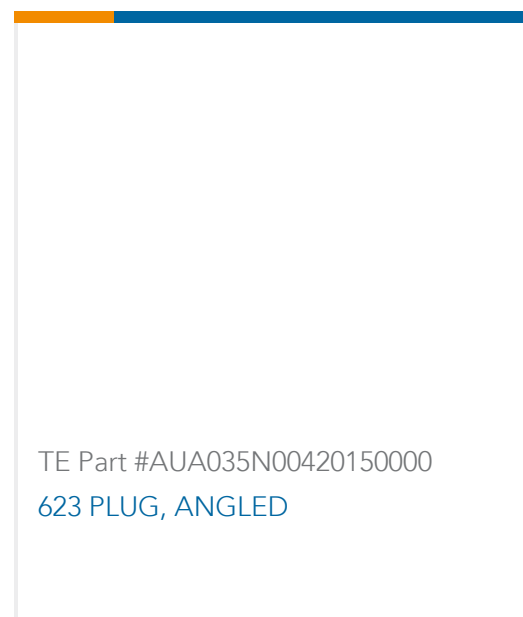
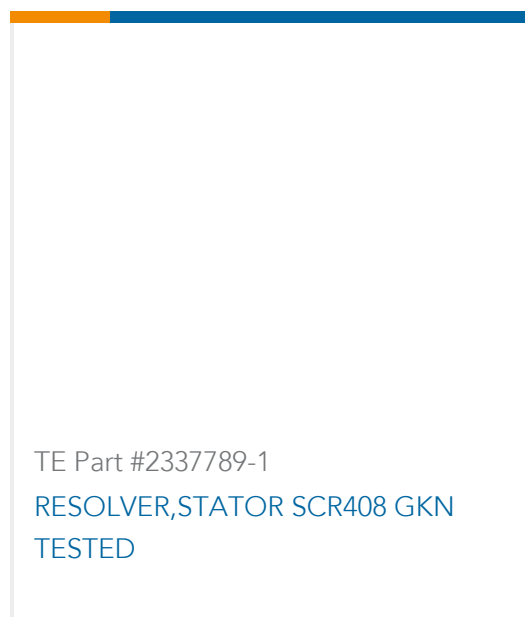

Documents

Product Drawings

[2POS, MCON 1.2 LL TAB SEALED COD A](#)

English

CAD Files

[3D PDF](#)

3D

Customer View Model

[ENG_CVM_CVM_1-1703498-1_C.2d_dxf.zip](#)

English

Customer View Model

[ENG_CVM_CVM_1-1703498-1_C.3d_igs.zip](#)

English

Customer View Model

[ENG_CVM_CVM_1-1703498-1_C.3d_stp.zip](#)

English

By downloading the CAD file I accept and agree to the [Terms and Conditions](#) of use.

Datasheets & Catalog Pages

[MCON Interconnection System](#)

English

Product Specifications

[Product Specification](#)

English