



CGS | CGS HS

TE Internal #: 1-1630001-2

10 Ω, Wire Wound, Power Resistor, 87.5 x 47.5 x 26 mm, 2

Termination, Loose Piece - Tray, 5 %, 100 W, ±50 ppm/°C, Solder

Lug Termination, CGS HS

[View on TE.com >](#)

Passive Components > Resistors > Chassis Mount Resistors > Power Resistors: Aluminum Housed, HSA



Resistor Type: **Power Resistor**

Passive Component Dimensions: **87.5 x 47.5 x 26 mm**

Number of Terminations: **2**

Packaging Method: **Loose Piece - Tray**

Passive Component Tolerance: **5 %**

[All Power Resistors: Aluminum Housed, HSA \(384\)](#)

Features

Product Type Features

Resistor Type	Power Resistor
Element Type	Wire Wound

Configuration Features

Number of Resistors	1
---------------------	---

Electrical Characteristics

Voltage Rating	1900 VDC
Passive Component Tolerance	5 %
Resistance Class	Up to 1kΩ
Resistance Value	10 Ω
Power Rating	100 W

Termination Features

Number of Terminations	2
Chassis Mount Resistor Termination Type	Solder Lug

Mechanical Attachment

Chassis Mount Resistor Mount Style	Chassis Mount
------------------------------------	---------------

Dimensions

--	--

Passive Component Dimensions	87.5 x 47.5 x 26 mm
------------------------------	---------------------

Usage Conditions

Temperature Coefficient	± 50 ppm/ $^{\circ}$ C
-------------------------	----------------------------

Packaging Features

Packaging Method	Loose Piece - Tray
------------------	--------------------

Product Compliance

[For compliance documentation, visit the product page on TE.com>](#)

EU RoHS Directive 2011/65/EU	Compliant
EU ELV Directive 2000/53/EC	Compliant
China RoHS 2 Directive MIIT Order No 32, 2016	No Restricted Materials Above Threshold
EU REACH Regulation (EC) No. 1907/2006	Current ECHA Candidate List: JUNE 2023 (235) Candidate List Declared Against: JUNE 2023 (235) Does not contain REACH SVHC
Halogen Content	Low Halogen - Br, Cl, F, I < 900 ppm per homogenous material. Also BFR/CFR/PVC Free
Solder Process Capability	Not applicable for solder process capability

Product Compliance Disclaimer

This information is provided based on reasonable inquiry of our suppliers and represents our current actual knowledge based on the information they provided. This information is subject to change. The part numbers that TE has identified as EU RoHS compliant have a maximum concentration of 0.1% by weight in homogenous materials for lead, hexavalent chromium, mercury, PBB, PBDE, DBP, BBP, DEHP, DIBP, and 0.01% for cadmium, or qualify for an exemption to these limits as defined in the Annexes of Directive 2011/65/EU (RoHS2). Finished electrical and electronic equipment products will be CE marked as required by Directive 2011/65/EU. Components may not be CE marked. Additionally, the part numbers that TE has identified as EU ELV compliant have a maximum concentration of 0.1% by weight in homogenous materials for lead, hexavalent chromium, and mercury, and 0.01% for cadmium, or qualify for an exemption to these limits as defined in the Annexes of Directive 2000/53/EC (ELV). Regarding the REACH Regulation, the information TE provides on SVHC in articles for this part number is based on the latest European Chemicals Agency (ECHA) 'Guidance on requirements for substances in articles' posted at this URL: <https://echa.europa.eu/guidance-documents/guidance-on-reach>

Compatible Parts





TE Part # CAT-C339-H85913B
Power Resistors: Aluminum Housed, HSC



TE Part # CAT-C339-H85913
Power Resistors: Aluminum Housed, HSA

Also in the Series | CGS HS



Automotive Housings(31)

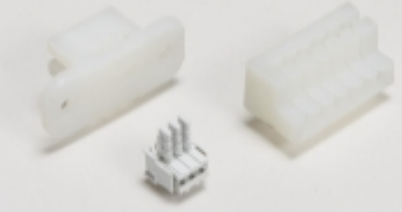

Card Edge Connector Housings(2)



Chassis Mount Resistors(603)



FFC Connectors(1)

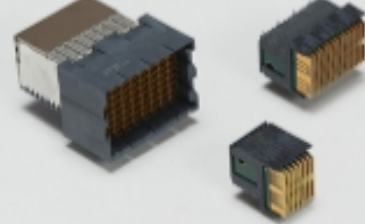

High Speed Backplane Connectors(11)



PCB Headers & Receptacles(2)



Plug & Socket Lighting Connector Accessories(1)



RJ45 Connectors(1)



Wire-to-Board Connector Assemblies & Housings(2)

Customers Also Bought



TE Part #D369-R66-NS0
369 6 WAY REC, NO CONTACTS, SKT



TE Part #1630013-3
NHSC150 6R8 5%



TE Part #2042274-2
ELCON MINI 2P VERT HEADER,W/O CODING



TE Part #1982299-4
ELCON MINI 2P CABLE CONN,W/O CODING

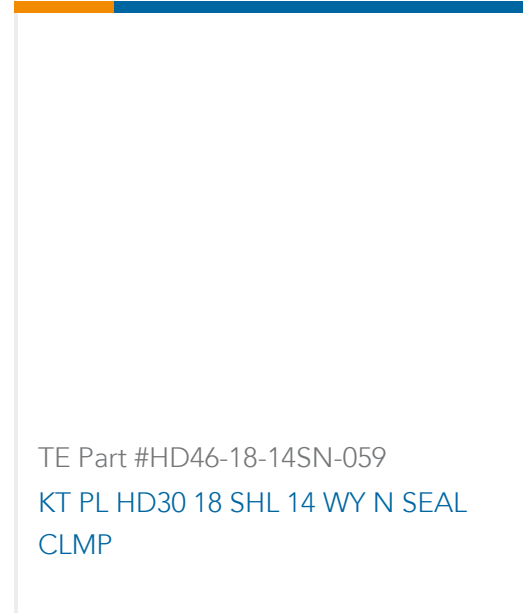
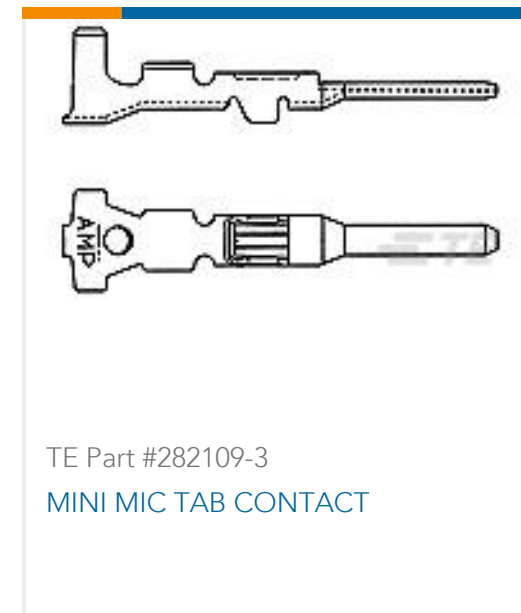
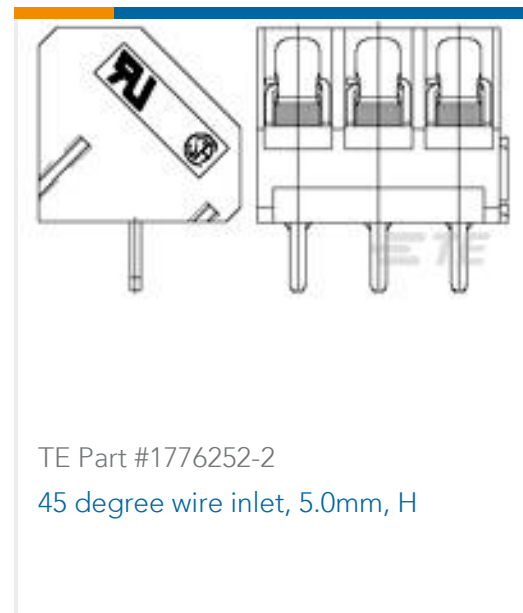
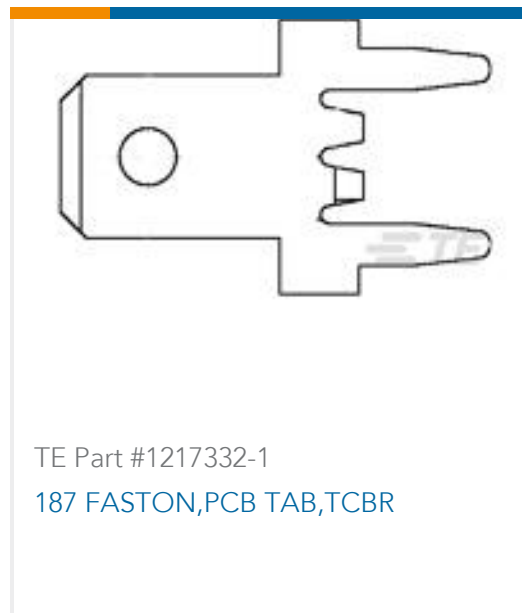

Documents

Product Drawings

[NHSC100 10R 5%](#)

English

CAD Files

Customer View Model

[ENG_CVM_CVM_1-1630001-2_L.2d_dxf.zip](#)

English

3D PDF

3D

Customer View Model

[ENG_CVM_CVM_1-1630001-2_L.3d_igs.zip](#)

English

Customer View Model

[ENG_CVM_CVM_1-1630001-2_L.3d_stp.zip](#)

English

By downloading the CAD file I accept and agree to the [Terms and Conditions](#) of use.

Datasheets & Catalog Pages

[1309350_PASSIVE_COMPONENT](#)

English

[8-1773459-4_POWER_FILTERING_AND_RESISTIVE_SOLUTIONS_FOR_ELEVATORS_AND_ESCALATORS](#)

English