



AMP MCP Connector System

TE Internal #: 1-1241418-3

Automotive Terminals, Receptacle, Mating Tab Width 6.3 mm / 5.8 mm / 4.8 mm [.228 in / .189 in / .248 in], AMP MCP Connector System

[View on TE.com >](#)

Terminals & Splices > Automotive Terminals > AMP MCP, RECEPTACLE AND TAB

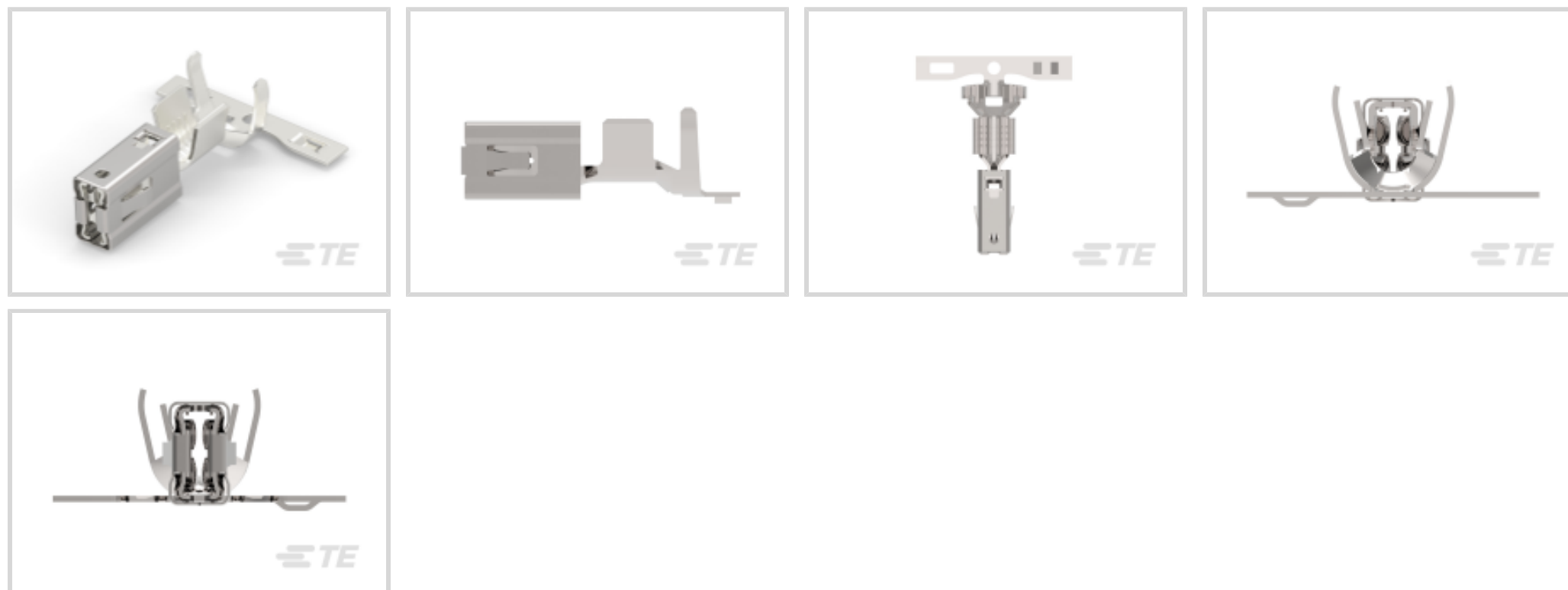

Terminal Type: **Receptacle**

Mating Tab Width: 4.8 mm, 5.8 mm, 6.3 mm [.189 in, .228 in, .248 in]

Mating Tab Thickness: .8 mm [.031 in]

Terminal Transmits: 25 – 40 A (Power)

Wire Size: 11 – 9 AWG

[All AMP MCP, RECEPTACLE AND TAB \(129\)](#)

**Features**

**Product Type Features**

Receptacle Style	180°
Sealable	Yes
Primary Locking Feature	Locking Lance

**Body Features**

Terminal Seal Type	Single Wire Seal (SWS)
--------------------	------------------------

**Contact Features**

Contact Size	4.8mm, 6.3mm
Contact Fabrication	Stamped & Formed
Wire Contact Termination Area Plating Material	Tin
Typical Current Rating	37 A
Crimp Type	F-Crimp
Terminal Type	Receptacle



Mating Tab Width	4.8 mm, 5.8 mm, 6.3 mm [.189 in][.228 in][.248 in]
Mating Tab Thickness	.8 mm [.031 in]
Interface Plating	Silver (Ag)

### Termination Features

Termination Method to Wire & Cable	Crimp
Product Terminates To	Wire

### Dimensions

Compatible Insulation Diameter Range	3.4 – 4.3 mm [.132 – .168 in]
Wire Size	4 – 6 mm <sup>2</sup>
Wire Size Search	9 AWG, 10 AWG, 11 AWG

### Usage Conditions

Insulation Option	Uninsulated
Operating Temperature (Max)	80 °C, 85 °C, 90 °C, 100 °C, 105 °C, 110 °C, 120 °C, 125 °C, 130 °C, 140 °C [176 °F][185 °F][194 °F][212 °F][221 °F][230 °F][248 °F][257 °F][266 °F][284 °F]
Operating Temperature Range	-40 – 140 °C [-40 – 284 °F]

### Operation/Application

Conforms to KOMAX Automatic Component Insertion Guideline	Yes, per Version 5.0 (March 2018)
Compatible With Wire Base Material	Copper

### Industry Standards

Agency/Standard	LV214
-----------------	-------

### Packaging Features

Packaging Quantity	1500
Packaging Method	Reel

### Other

Terminal Transmits	25 – 40 A (Power)
--------------------	-------------------

### Product Compliance

[For compliance documentation, visit the product page on TE.com>](#)

EU RoHS Directive 2011/65/EU	Compliant
EU ELV Directive 2000/53/EC	Compliant



China RoHS 2 Directive MIIT Order No 32, 2016

No Restricted Materials Above Threshold

EU REACH Regulation (EC) No. 1907/2006

Current ECHA Candidate List: JUNE 2023 (235)

Candidate List Declared Against: JUNE 2023 (235)

Does not contain REACH SVHC

Halogen Content

Low Halogen - Br, Cl, F, I < 900 ppm per homogenous material. Also BFR/CFR/PVC Free

Solder Process Capability

Not reviewed for solder process capability

Product Compliance Disclaimer

This information is provided based on reasonable inquiry of our suppliers and represents our current actual knowledge based on the information they provided. This information is subject to change. The part numbers that TE has identified as EU RoHS compliant have a maximum concentration of 0.1% by weight in homogenous materials for lead, hexavalent chromium, mercury, PBB, PBDE, DBP, BBP, DEHP, DIBP, and 0.01% for cadmium, or qualify for an exemption to these limits as defined in the Annexes of Directive 2011/65/EU (RoHS2). Finished electrical and electronic equipment products will be CE marked as required by Directive 2011/65/EU. Components may not be CE marked. Additionally, the part numbers that TE has identified as EU ELV compliant have a maximum concentration of 0.1% by weight in homogenous materials for lead, hexavalent chromium, and mercury, and 0.01% for cadmium, or qualify for an exemption to these limits as defined in the Annexes of Directive 2000/53/EC (ELV). Regarding the REACH Regulation, the information TE provides on SVHC in articles for this part number is based on the latest European Chemicals Agency (ECHA) 'Guidance on requirements for substances in articles' posted at this URL: <https://echa.europa.eu/guidance-documents/guidance-on-reach>

## Compatible Parts



TE Part # CAT-L489-CH8172  
LEAVYSEAL Housings



TE Part # CAT-H3399-CH8172  
Heavy Duty Sealed Connector Series Housings



TE Part # 1-1418507-2  
SOCKET HSG 4POS.,AMP MCP2.8 /MCP6.3K



TE Part # 1-1579007-3  
EXTRACTION TOOL



TE Part # 1719043-1  
SINGLE WIRE SEAL, GREEN



TE Part # 1394512-1  
EINZELLEITDICHTG, BL



TE Part # 2305570-1  
Strip Terminal Cutter-Side Feed-No Crimp



TE Part # 1-1718628-1  
AMP MCP 2.8 HSG. 4POS., ASS'Y



TE Part # 1-2344950-1  
95POS, HYBRID, REC HSG, ASSY, COD A



TE Part # 2-2344950-1  
95POS, HYBRID, REC HSG, ASSY, COD B



TE Part # 2151466-1  
OCEAN\_2.0\_APPLICATOR-S-160F2700



TE Part # 2151466-2  
OCEAN\_2.0\_APPLICATOR-S-160F2700



TE Part # 5-2151466-1  
OCEAN\_2.0\_APPLICATOR-S-160F2700



TE Part # 5-2151466-2  
OCEAN\_2.0\_APPLICATOR-S-160F2700



TE Part # 7-2151466-1  
OCEAN\_2.0\_APPLICATOR-S-160F2700



TE Part # 7-2151466-2  
OCEAN\_2.0\_APPLICATOR-S-160F2700



**KIT**  
REPRESENTATION ONLY

TE Part # 7-2151466-7  
OCEAN\_2.0\_SPARE\_PART\_KIT-160F2700



**KIT**  
REPRESENTATION ONLY

TE Part # 7-2836147-7  
OC-160F2700-752-CRIMPTOOLINGKIT



TE Part # 2-2151466-1  
OCEAN\_2.0\_APPLICATOR-S-160F2700



TE Part # 2-2151466-2  
OCEAN\_2.0\_APPLICATOR-S-160F2700

Also in the Series | AMP MCP Connector System



Automotive Connector Caps & Covers (25)



Automotive Connector Locks & Position Assurance(7)



Automotive Housings(360)



Automotive Terminals(135)



Connector Seals & Cavity Plugs(7)



Insertion & Extraction Tools(13)

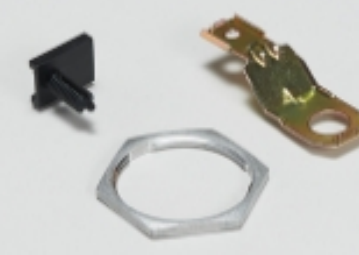

Other Automotive Connector Accessories(2)



PCB Headers & Receptacles(30)

Customers Also Bought



TE Part #1-1564542-1  
2POS,AMP MCP6.3/4.8K,REC HSG,A



TE Part #1719043-1  
SINGLE WIRE SEAL,GREEN



TE Part #2-2112966-2  
TIMER, RECEPTACLE AND TAB



TE Part #2141828-1  
MQS0,63 Sn tab LL unseal. 0,13-0,17



TE Part #1564982-3  
AMP MCP 2.8K, CONTACT



TE Part #2236060-1  
COVER,ASSY

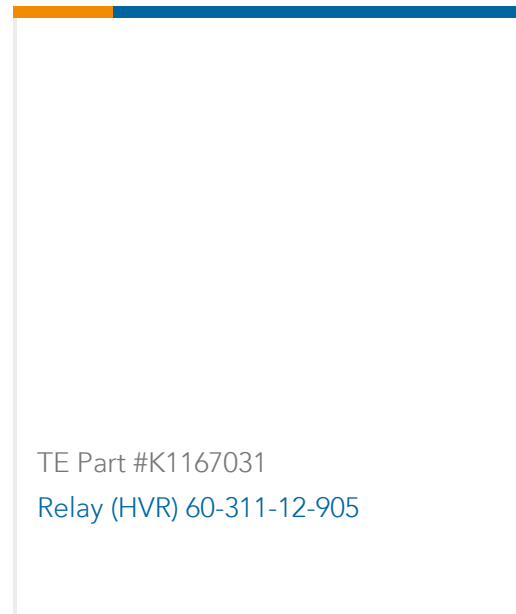

TE Part #K1167031  
Relay (HVR) 60-311-12-905

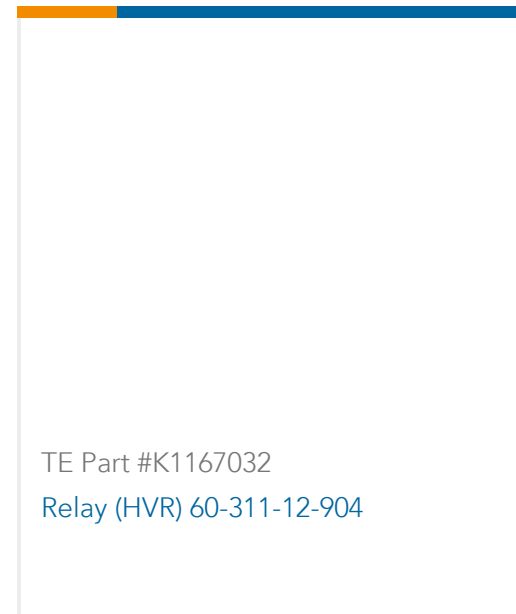

TE Part #K1167032  
Relay (HVR) 60-311-12-904

## Documents

### Product Drawings

[AMP MCP 6.3/4.8K, CONTACT, SWS](#)

English

### CAD Files

[3D PDF](#)

3D

Customer View Model

[ENG\\_CVM\\_CVM\\_1-1241418-3\\_A.2d\\_dxf.zip](#)

English

Customer View Model

[ENG\\_CVM\\_CVM\\_1-1241418-3\\_A.3d\\_igs.zip](#)

English

Customer View Model

[ENG\\_CVM\\_CVM\\_1-1241418-3\\_A.3d\\_stp.zip](#)

English

By downloading the CAD file I accept and agree to the [Terms and Conditions](#) of use.

### Datasheets & Catalog Pages

[HDSCS Catalog](#)

English

[CONNECTOR SELECTOR](#)

English

### Product Specifications

[Application Specification](#)

German



## Application Specification

English