

BACA-AMP-140 ✓ ACTIVE

AMPMODU | AMPMODU IV/V

TE Internal #: 1-104481-1

Connector Contact, Socket, Wire-to-Board, 32 – 28 AWG Wire Size,
59.2 – 177.62 CMA Wire Size, .03 – .09 mm² Wire Size, Gold, Reel,
AMPMODU IV/V

[View on TE.com >](#)



Connectors > PCB Connectors > Wire-to-Board Connectors > Wire-to-Board Connector Contacts



Contact Type: **Socket**

Connector System: **Wire-to-Board**

Wire Size: **.03 – .09 mm²**

Features

Product Type Features

Applied Pressure	Standard
Connector System	Wire-to-Board
Connector & Contact Terminates To	Wire & Cable

Configuration Features

Compatible With Wire & Cable Type	Discrete Wire
-----------------------------------	---------------

Electrical Characteristics

Termination Resistance	12 mΩ
Insulation Resistance	5000 MΩ
Dielectric Withstanding Voltage (Max)	750 V
Operating Voltage	300 VAC

Contact Features

Mating Square Post Dimension	.64 mm[.025 in]
	30 μin
Wire Contact Termination Area Plating Material	Tin
Contact Base Material	Copper Alloy



Contact Type	Socket
Contact Mating Area Plating Material	Gold
Contact Current Rating (Max)	3 A

Termination Features

Termination Method to Wire & Cable	Crimp
------------------------------------	-------

Mechanical Attachment

Wire Insulation Support	With
-------------------------	------

Dimensions

Compatible Insulation Diameter Range	.64 – 1.52 mm [.025 – .06 in]
Wire Size	.03 – .09 mm ²

Usage Conditions

Operating Temperature Range	-65 – 105 °C [-85 – 221 °F]
-----------------------------	-----------------------------

Operation/Application

Circuit Application	Power & Signal
---------------------	----------------

Industry Standards

Approved Standards	CSA LR7189, UL E28476
--------------------	-----------------------

Packaging Features

Packaging Quantity	15000
Packaging Method	Reel

Product Compliance

[For compliance documentation, visit the product page on TE.com>](#)

EU RoHS Directive 2011/65/EU	Compliant
EU ELV Directive 2000/53/EC	Compliant
China RoHS 2 Directive MIIT Order No 32, 2016	No Restricted Materials Above Threshold
EU REACH Regulation (EC) No. 1907/2006	Current ECHA Candidate List: JUNE 2023 (235) Candidate List Declared Against: JUNE 2023 (235) Does not contain REACH SVHC
Halogen Content	Low Halogen - Br, Cl, F, I < 900 ppm per homogenous material. Also BFR/CFR/PVC Free
Solder Process Capability	Not applicable for solder process capability



Product Compliance Disclaimer

This information is provided based on reasonable inquiry of our suppliers and represents our current actual knowledge based on the information they provided. This information is subject to change. The part numbers that TE has identified as EU RoHS compliant have a maximum concentration of 0.1% by weight in homogenous materials for lead, hexavalent chromium, mercury, PBB, PBDE, DBP, BBP, DEHP, DIBP, and 0.01% for cadmium, or qualify for an exemption to these limits as defined in the Annexes of Directive 2011/65/EU (RoHS2). Finished electrical and electronic equipment products will be CE marked as required by Directive 2011/65/EU. Components may not be CE marked. Additionally, the part numbers that TE has identified as EU ELV compliant have a maximum concentration of 0.1% by weight in homogenous materials for lead, hexavalent chromium, and mercury, and 0.01% for cadmium, or qualify for an exemption to these limits as defined in the Annexes of Directive 2000/53/EC (ELV). Regarding the REACH Regulation, the information TE provides on SVHC in articles for this part number is based on the latest European Chemicals Agency (ECHA) 'Guidance on requirements for substances in articles' posted at this URL: <https://echa.europa.eu/guidance-documents/guidance-on-reach>

Compatible Parts



TE Part # 91518-1
 CCI AMPMODU SHORT POINT REC
 32-22 ASSY



TE Part # 1-104482-8
 40 SHORT PT RCPT HSG DR .100CL



TE Part # 104483-4
 26 SHORT PT RCPT HSG DR .100CL



TE Part # 104257-9
 10 MTE RCPT HSG SR LATCH .100



TE Part # 1-104257-3
 14 MTE RCPT HSG SR LATCH .100



TE Part # 104257-6
 07 MTE RCPT HSG SR LATCH .100



TE Part # 104257-7
 08 MTE RCPT HSG SR LATCH .100



TE Part # 1-104257-5
 16 MTE RCPT HSG SR LATCH .100



TE Part # 104257-2
 03 MTE RCPT HSG SR LATCH .100



TE Part # 104257-5
 06 MTE RCPT HSG SR LATCH .100



TE Part # 103648-7
 08 MTE RCPT HSG SR RIB .100CL



TE Part # 104257-3
 04 MTE RCPT HSG SR LATCH .100



Also in the Series | AMPMODU IV/V

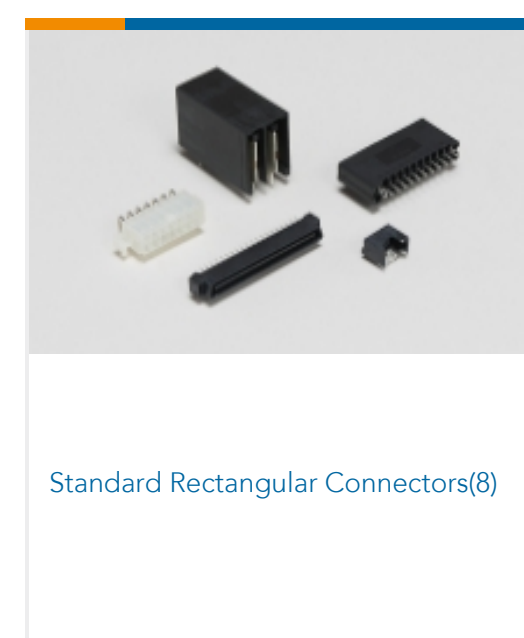
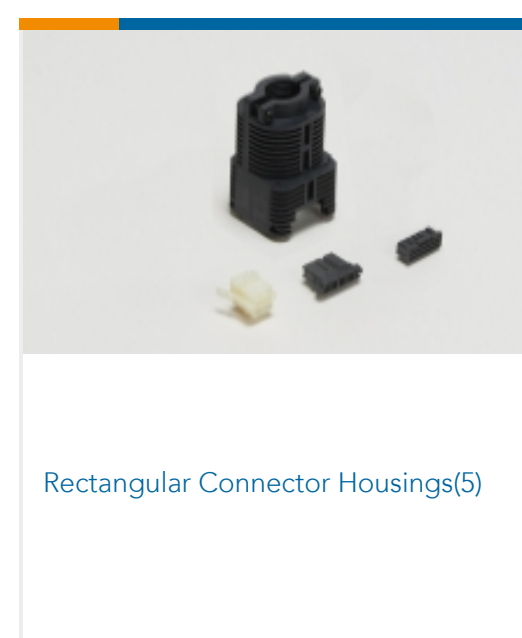
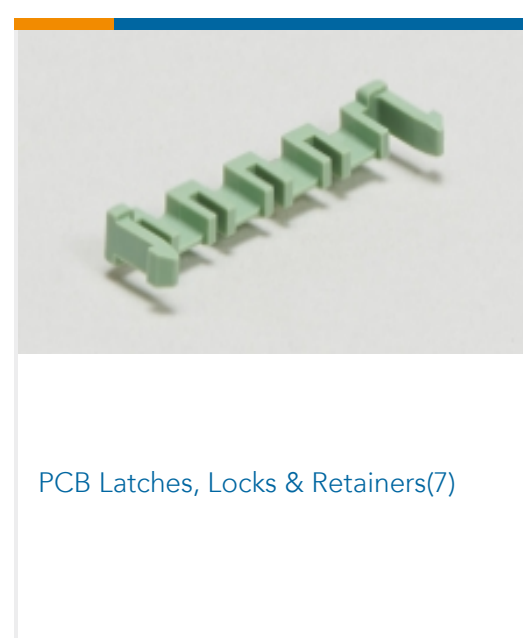
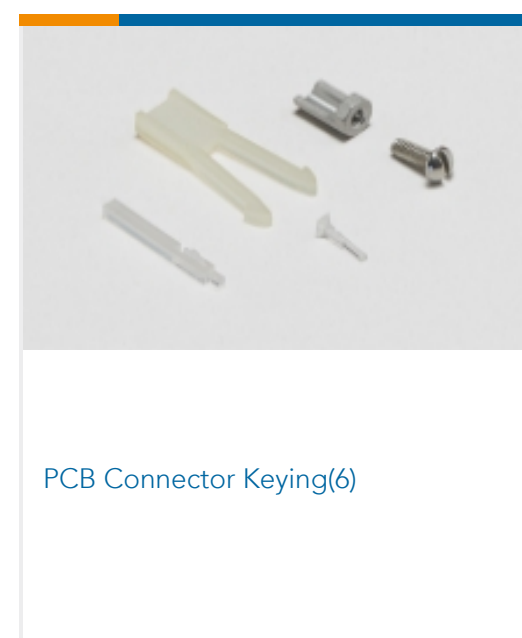
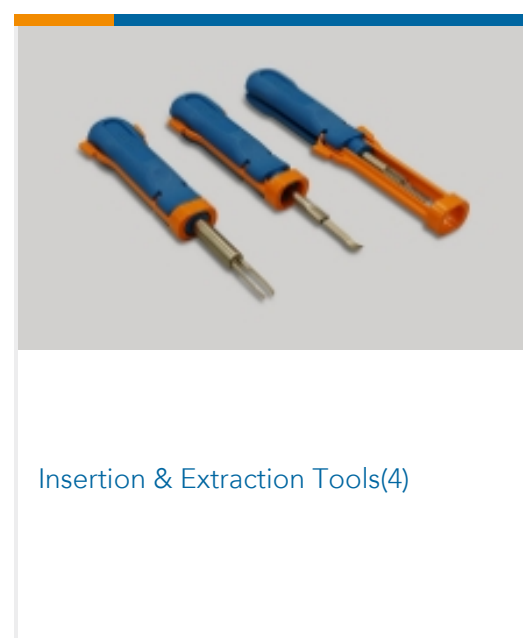
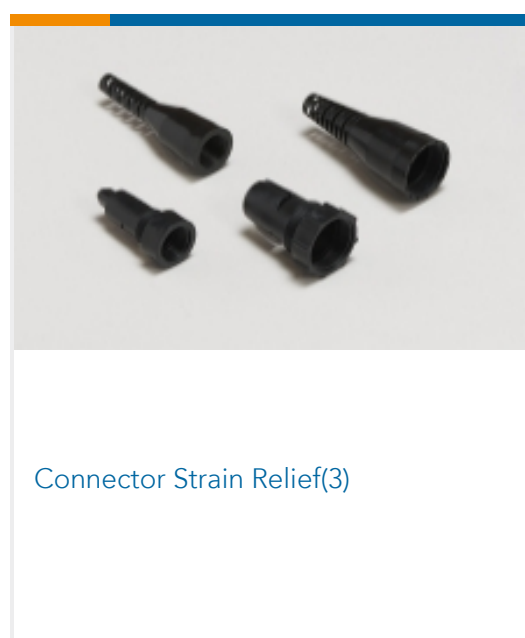
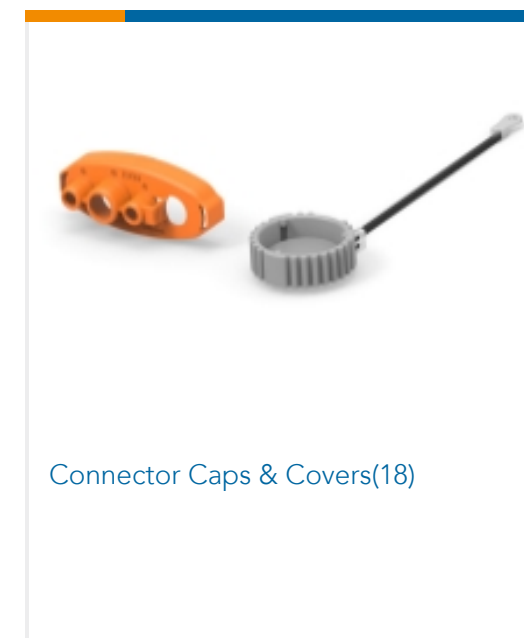
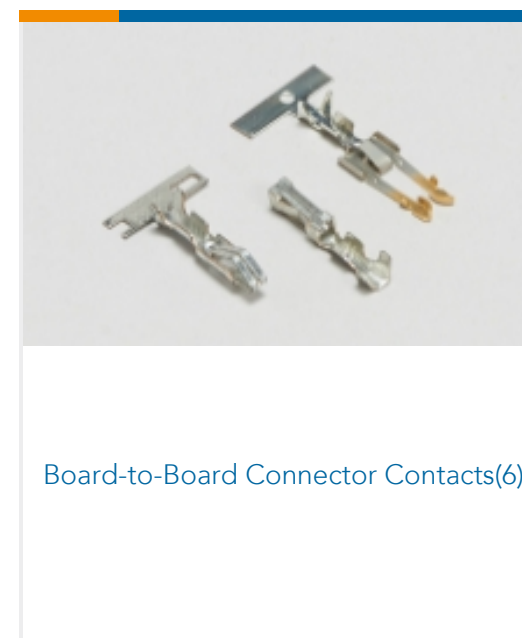
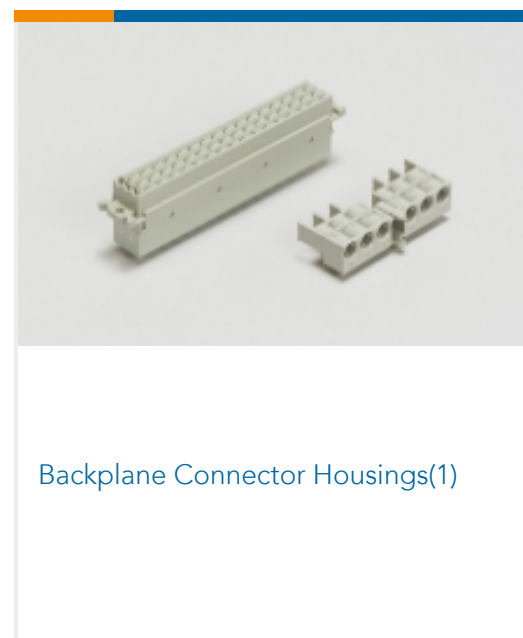
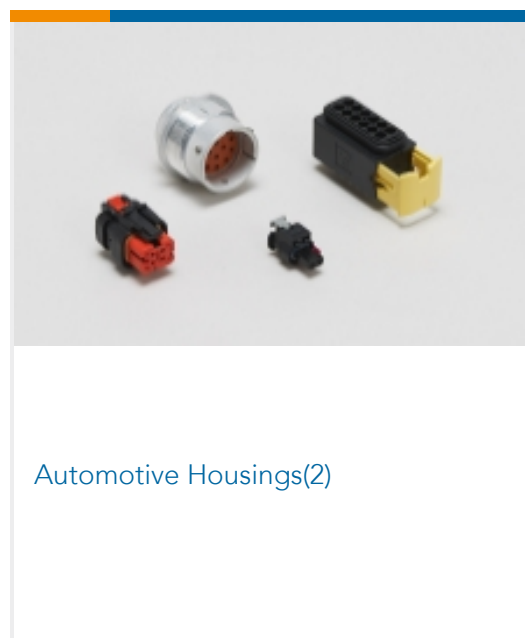



Wire-to-Board Connector Assemblies & Housings(447)



Wire-to-Board Connector Contacts (322)

Customers Also Bought



TE Part #1-66332-4
III+ PIN,24-20,TIN ,STRIP

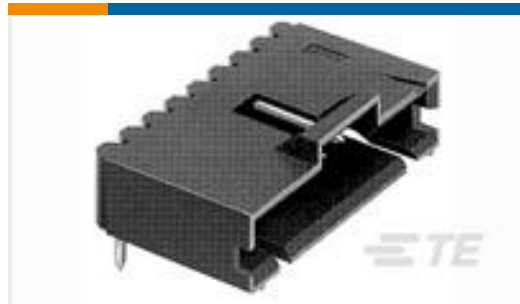

TE Part #5-104935-3
03 MTE HDR SRRA LATCH



TE Part #350732-4
06P UMNL PIN HDR ASSY 94VO LF



TE Part #350825-4
03P UMNL HDR ASSY PC 94VO LF

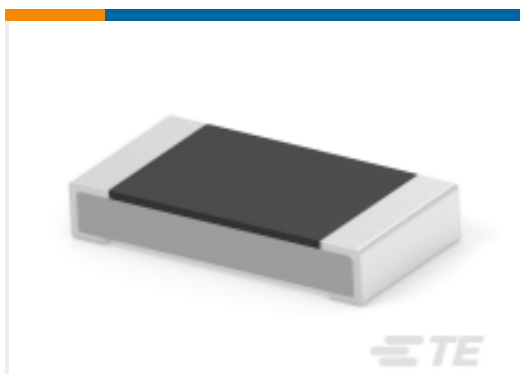

TE Part #2176392-9
RQ 1206 162K 0.1% 10PPM 5K RL

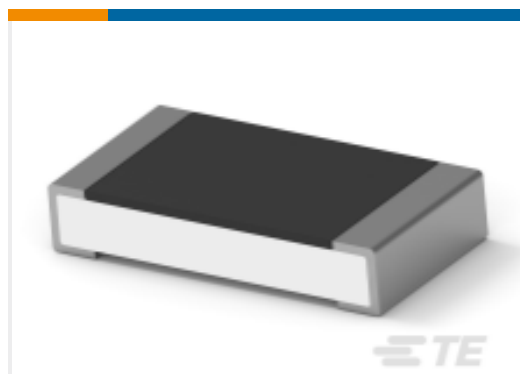

TE Part #2-2176391-1
RQ 1206 20K 0.1% 10PPM 5K RL

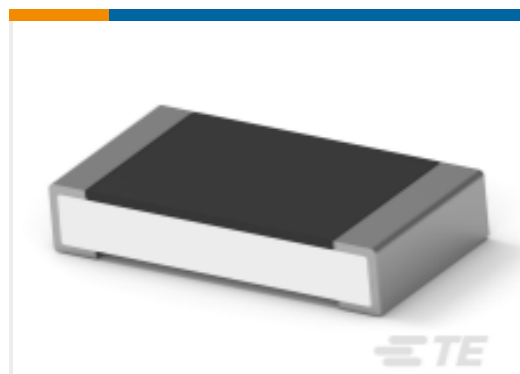

TE Part #7-2176391-7
RQ 1206 76K8 0.1% 10PPM 5K RL

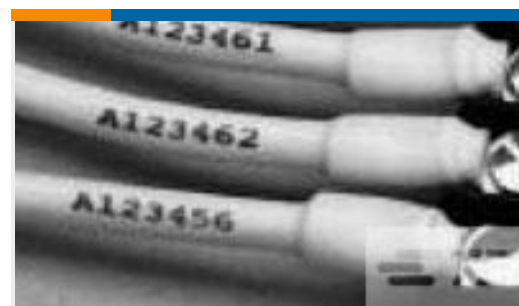

TE Part #CV4186-000
RNF-100-1/4-BK-SP-SH



TE Part #350834-4
06P UMNL HDR ASSY PC 94VO LF



TE Part #2267473-4
SIZE 13 PERIPHERAL SEAL, CPC

Documents

Product Drawings

[SHORT POINT CONT 30 DPLX STMPD LF](#)

English

CAD Files

[Customer View Model](#)

[ENG_CVM_1-104481-1_N.2d_dxf.zip](#)

English

[3D PDF](#)



English

Customer View Model

[ENG_CVM_1-104481-1_N.3d_igs.zip](#)

English

Customer View Model

[ENG_CVM_1-104481-1_N.3d_stp.zip](#)

English

By downloading the CAD file I accept and agree to the [Terms and Conditions](#) of use.

Datasheets & Catalog Pages

[AMPMODU_INTERCONNECTION_SYSTEM_SECTION5_CONT](#)

English

[AMPMODU MTE INTERCONNECT SYSTEM](#)

English

Product Specifications

[Application Specification](#)

English

Product Environmental Compliance

[MD_1-104481-1_03192018733_dmtec](#)

English

[MD_1-104481-1_03192018733_dmtec](#)

English