

S1030-TAPE-3/4X33FT ✓ ACTIVE

RAYCHEM

TE Internal #: 095226-000

Hot Melt Tape, Polyolefin Adhesive, -80 – 80 °C

[View on TE.com >](#)



Wire Protection & Management > Adhesives & Sealants > Hot Melt Tape

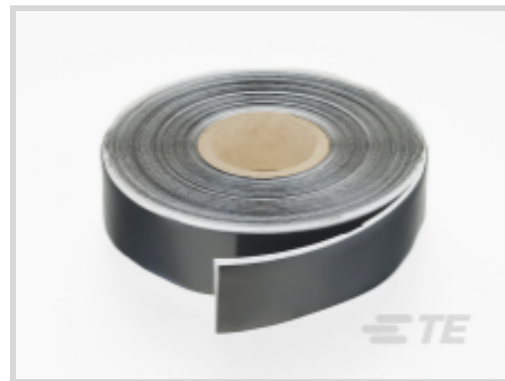

Adhesive Type: **Polyolefin Adhesive**

Operating Temperature Range: **-80 – 80 °C**

Features

Product Type Features

Adhesive Type	Polyolefin Adhesive
---------------	---------------------

Dimensions

Product Length	10 m[33 ft]
Product Width	19 mm[.75 in]

Usage Conditions

Installation Temperature	120 °C
Operating Temperature Range	-80 – 80 °C

Industry Standards

Adhesive Specification	RK-6017, RT-1050/6
------------------------	--------------------

Packaging Features

Packaging Method	Roll
------------------	------

Other

Adhesives & Sealants Comment	Good low temperature flexibility.
Adhesive Code	180, S1030

Product Compliance

[For compliance documentation, visit the product page on TE.com>](#)

EU RoHS Directive 2011/65/EU	Compliant
EU ELV Directive 2000/53/EC	Compliant
China RoHS 2 Directive MIIT Order No 32, 2016	No Restricted Materials Above Threshold

EU REACH Regulation (EC) No. 1907/2006

Current ECHA Candidate List: JUNE 2023 (235)

Candidate List Declared Against: JUNE 2023 (235)

Does not contain REACH SVHC

Halogen Content

Low Halogen - Br, Cl, F, I < 900 ppm per homogenous material. Also BFR/CFR/PVC Free

Solder Process Capability

Not applicable for solder process capability

Product Compliance Disclaimer

This information is provided based on reasonable inquiry of our suppliers and represents our current actual knowledge based on the information they provided. This information is subject to change. The part numbers that TE has identified as EU RoHS compliant have a maximum concentration of 0.1% by weight in homogenous materials for lead, hexavalent chromium, mercury, PBB, PBDE, DBP, BBP, DEHP, DIBP, and 0.01% for cadmium, or qualify for an exemption to these limits as defined in the Annexes of Directive 2011/65/EU (RoHS2). Finished electrical and electronic equipment products will be CE marked as required by Directive 2011/65/EU. Components may not be CE marked. Additionally, the part numbers that TE has identified as EU ELV compliant have a maximum concentration of 0.1% by weight in homogenous materials for lead, hexavalent chromium, and mercury, and 0.01% for cadmium, or qualify for an exemption to these limits as defined in the Annexes of Directive 2000/53/EC (ELV). Regarding the REACH Regulation, the information TE provides on SVHC in articles for this part number is based on the latest European Chemicals Agency (ECHA) 'Guidance on requirements for substances in articles' posted at this URL: <https://echa.europa.eu/guidance-documents/guidance-on-reach>

Compatible Parts



TE Part # CAT-R21-7310723
Low Profile Heat Shrink Boots: Poly Molded, Lipped, Straight



TE Part # CAT-R21-73106549
Bulbous Heat Shrink Boots: Lipped, Right Angle

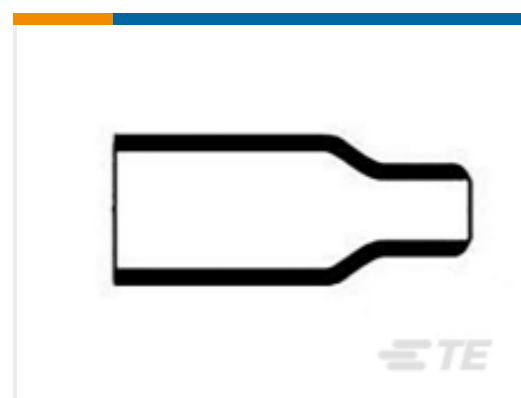

TE Part # CAT-R21-731
Heat Shrink Boots: Non Lipped, Straight

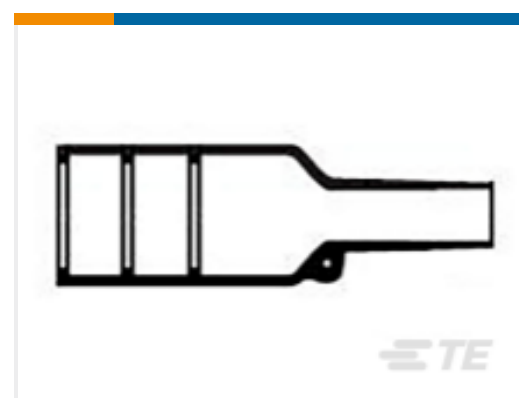

TE Part # CAT-R21-731072
Bulbous Heat Shrink Boots: Lipped, Straight



TE Part # CAT-R21-7310654
Heat Shrink Boots: Non Lipped, Right Angle

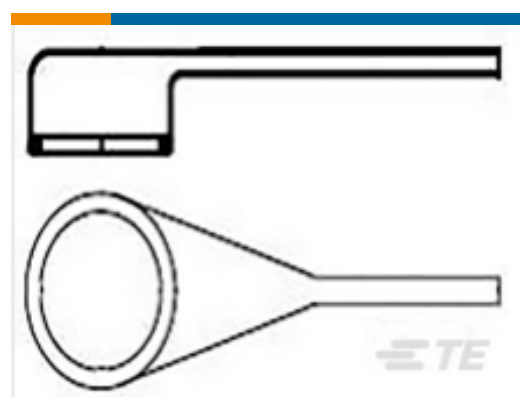

TE Part # CAT-R21-7310554
Heat Shrink Boots: Lipped, Right Angle

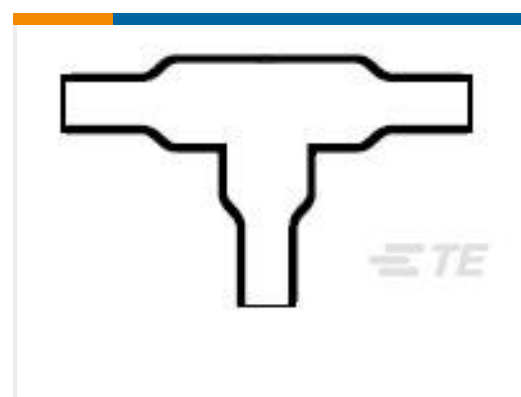

TE Part # 740740-000
301A034-100-0

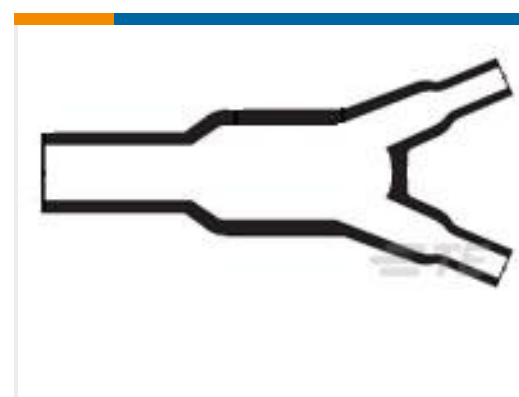

TE Part # 827914-000
382A034-100-0



TE Part # 439087-000
101A062-100-0



TE Part # 322629-000
101A073-100-0

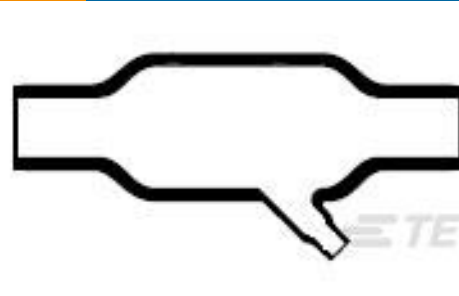

TE Part # 301221-000
342A024-100-0

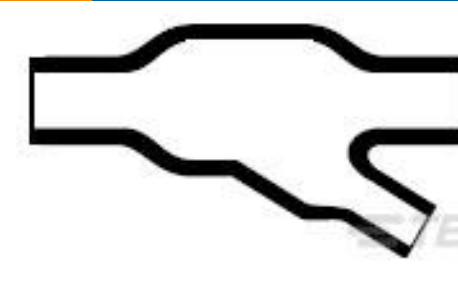

TE Part # 599886-000
362A014-100-0

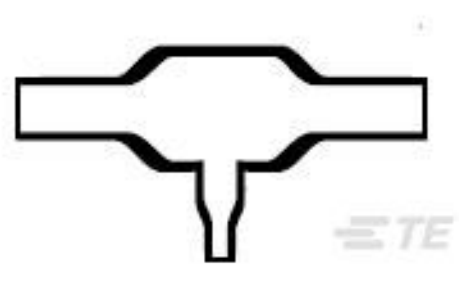

TE Part # 559769-000
322A134-100-0



TE Part # 590655-000
101A094-100-0

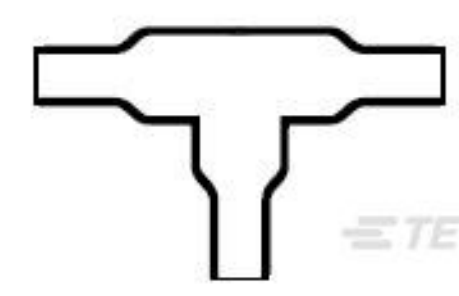

TE Part # 630918-000
301A011-100-0

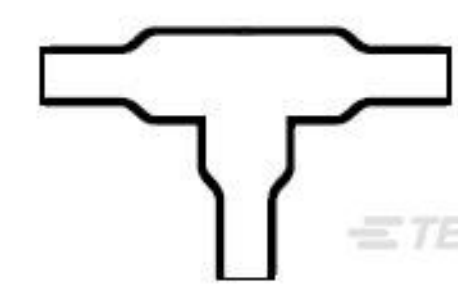

TE Part # 246977-000
301A022-100-0

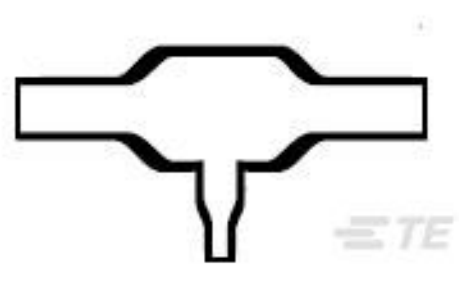

TE Part # 580522-000
322A112-100-0

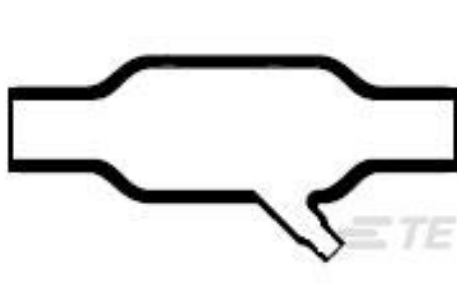

TE Part # 940811-000
342A012-100-0



TE Part # 515995-000
342A034-100-0

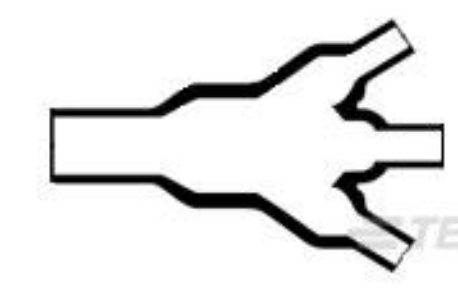

TE Part # 391025-000
462A011-100-0

Customers Also Bought

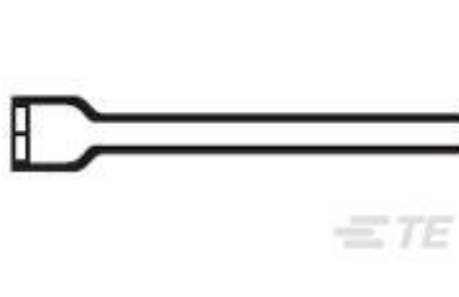

TE Part #904734-000
202F211-71-0



TE Part #6609108-2
PE0S0DZ6C M0=C7019



TE Part #2-2176414-9
7W STD M/OX 5% 300R



TE Part #3-2176414-0
7W STD M/OX 5% 330R



TE Part #625006-000
D-136-21



TE Part #K1060274
Relay 26-06-13

TE Part #ZPF00000000097199
086-0607-08



TE Part #YDBC54H-2221PNV001
HERM RECP

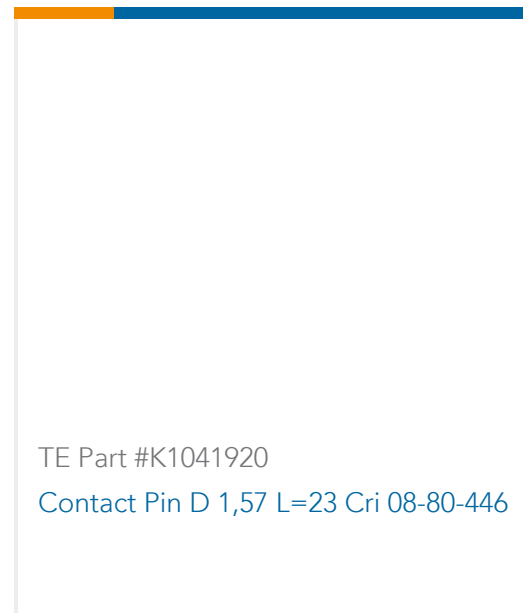
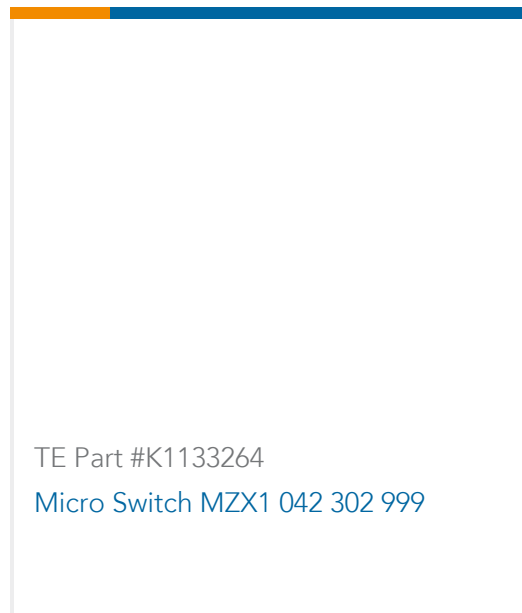

Documents

Product Drawings

[S1030-TAPE-3/4X33FT](#)

English

Datasheets & Catalog Pages

[Adhesives Selection Guide](#)

English

Product Specifications

[S1030 ADHESIVE TAPE](#)

English

[Thermofit Adhesive and Sealant Thermofit S-1030](#)

English

Product Environmental Compliance

[Safety Datasheet](#)

English

[Safety Datasheet](#)

English