

SERIES: PRMC3-S | DESCRIPTION: DC-DC CONVERTER
FEATURES

- 3 W isolated output
- smaller package
- single/dual regulated outputs
- 3,000 Vdc isolation
- continuous short circuit protection
- temperature range (-40~105°C)
- efficiency up to 84%
- EN/BS EN 62368-1 certified

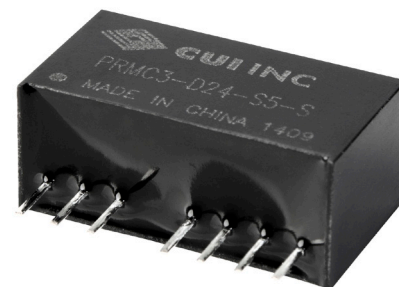

MODEL	input voltage		output voltage (Vdc)	output current		output power max (W)	ripple and noise ¹ max (mVp-p)	efficiency typ (%)
	typ (Vdc)	range (Vdc)		min (mA)	max (mA)			
PRMC3-D5-S5-S ²	5	4.5~9	5	25	500	2.5	100	73
PRMC3-D5-S9-S ²	5	4.5~9	9	14	278	2.5	100	74
PRMC3-D5-S12-S ²	5	4.5~9	12	10	208	2.5	100	77
PRMC3-D5-S15-S ²	5	4.5~9	15	8	167	2.5	100	74
PRMC3-D5-D5-S ²	5	4.5~9	±5	±13	±250	2.5	100	74
PRMC3-D5-D12-S ²	5	4.5~9	±12	±5	±104	2.5	100	77
PRMC3-D5-D15-S ²	5	4.5~9	±15	±4	±83	2.5	100	77
PRMC3-D12-S3-S ²	12	9~18	3.3	38	758	2.5	100	74
PRMC3-D12-S5-S ²	12	9~18	5	30	600	3	100	76
PRMC3-D12-S12-S ²	12	9~18	12	13	250	3	100	82
PRMC3-D12-S15-S ²	12	9~18	15	10	200	3	100	83
PRMC3-D12-D5-S ²	12	9~18	±5	±15	±300	3	100	78
PRMC3-D12-D12-S ²	12	9~18	±12	±6	±125	3	100	79
PRMC3-D12-D15-S ²	12	9~18	±15	±5	±100	3	100	80
PRMC3-D24-S3-S ²	24	18~36	3.3	38	758	2.5	100	74
PRMC3-D24-S5-S ²	24	18~36	5	30	600	3	100	81
PRMC3-D24-S9-S ²	24	18~36	9	17	333	3	100	83
PRMC3-D24-S12-S ²	24	18~36	12	13	250	3	100	83
PRMC3-D24-S15-S ²	24	18~36	15	10	200	3	100	83
PRMC3-D24-S24-S ²	24	18~36	24	6	125	3	100	83
PRMC3-D24-D5-S ²	24	18~36	±5	±15	±300	3	100	79
PRMC3-D24-D12-S ²	24	18~36	±12	±6	±125	3	100	83
PRMC3-D24-D15-S ²	24	18~36	±15	±5	±100	3	100	83
PRMC3-D48-S5-S	48	36~75	5	30	600	3	100	76
PRMC3-D48-S12-S	48	36~75	12	13	250	3	100	80
PRMC3-D48-S15-S	48	36~75	15	10	200	3	100	84

MODEL (CONTINUED)

MODEL (CONTINUED)	input voltage		output voltage	output current		output power	ripple and noise ¹	efficiency
	typ (Vdc)	range (Vdc)	(Vdc)	min (mA)	max (mA)	max (W)	typ (mVp-p)	typ (%)
PRMC3-D48-D5-S	48	36~75	±5	±15	±300	3	100	79
PRMC3-D48-D12-S	48	36~75	±12	±6	±125	3	100	82
PRMC3-D48-D15-S	48	36~75	±15	±5	±100	3	100	82

Notes: 1. Ripple and noise are measured at 20 MHz BW by "parallel cable" method with 1 µF ceramic and 10 µF electrolytic capacitors on the output.
2. Model is not CE certified.

PART NUMBER KEY

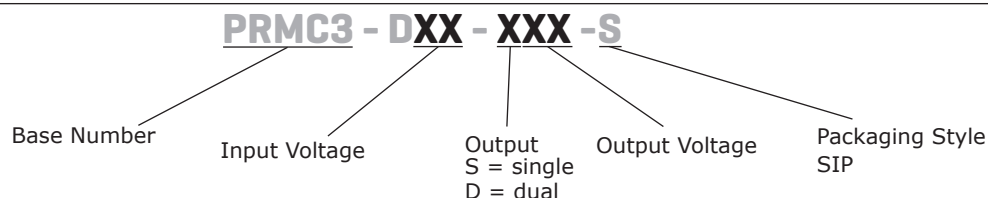

INPUT

parameter	conditions/description	min	typ	max	units
operating input voltage	5 Vdc input models	4.5	5	9	Vdc
	12 Vdc input models	9	12	18	Vdc
	24 Vdc input models	18	24	36	Vdc
	48 Vdc input models	36	48	75	Vdc
start-up voltage	5 Vdc input models	3.5	4	4.5	Vdc
	12 Vdc input models	4.5	8	9	Vdc
	24 Vdc input models	11	16	18	Vdc
	48 Vdc input models	24	33	36	Vdc
surge voltage	for maximum of 1 second				
	5 Vdc input models	-0.7		12	Vdc
	12 Vdc input models	-0.7		25	Vdc
	24 Vdc input models	-0.7		50	Vdc
filter	capacitance filter				
CTRL ³	models ON (CTRL open or insulated)				
	models OFF (connect voltage, current into CTRL is 5~10mA)				

Notes: 3. See application notes on page 6.

OUTPUT

parameter	conditions/description	min	typ	max	units
line regulation	full load, input voltage from low to high		±0.2	±0.5	%
load regulation	5% to 100% load		±0.2	±0.5	%
voltage accuracy	5% to 100% load		±1	±3	%
no-load voltage accuracy ⁴	input voltage range		±1.5	±5	%
voltage balance ⁵	dual output, balanced loads		±0.5	±1	%
switching frequency	100% load, nominal input voltage, PFM mode		250		KHz
transient recovery time	25% load step change		0.5	3	ms
transient response deviation	25% load step change		±2.5	±5	%
temperature coefficient	100% load		±0.02	±0.03	%/°C

Notes: 4. The max no-load voltage accuracy for PRMC3-D12-S3-S is ±8%
5. For dual output models, unbalanced loads should not exceed ±5%. If ±5% is exceeded, it may not meet all specifications.

PROTECTIONS

parameter	conditions/description	min	typ	max	units
short circuit protection	continuous, automatic recovery				

SAFETY AND COMPLIANCE

parameter	conditions/description	min	typ	max	units
isolation voltage	input to output for 1 minute at 1 mA max.	3,000			Vdc
isolation resistance	input to output at 500 Vdc	1,000			MΩ
safety approvals	certified to 62368-1: EN, BS EN				
conducted emissions	CISPR22/EN55022, class B (external circuit required, see Figure 1-b)				
radiated emissions	CISPR22/EN55022, class B (external circuit required, see Figure 1-b)				
ESD	IEC/EN61000-4-2, class B, contact ± 4kV				
radiated immunity	IEC/EN61000-4-3, class A, 10V/m				
EFT/burst	IEC/EN61000-4-4, class B, ± 2kV (external circuit required, see Figure 1-a)				
surge	IEC/EN61000-4-5, class B, ± 2kV (external circuit required, see Figure 1-a)				
conducted immunity	IEC/EN61000-4-6, class A, 3 Vr.m.s				
voltage dips & interruptions	IEC/EN61000-4-29, class B, 0%-70%				
MTBF	as per MIL-HDBK-217F @ 25°C	1,000,000			hours
RoHS	2011/65/EU				

ENVIRONMENTAL

parameter	conditions/description	min	typ	max	units
operating temperature	see derating curve	-40		105	°C
storage temperature		-55		125	°C
storage humidity	non-condensing			95	%
temperature rise	at full load, Ta=25°C		25		°C

SOLDERABILITY

parameter	conditions/description	min	typ	max	units
hand soldering	1.5 mm from case for 10 seconds			300	°C
wave soldering	see wave soldering profile			260	°C

MECHANICAL

parameter	conditions/description	min	typ	max	units
dimensions	22.00 x 9.50 x 12.00 (0.866 x 0.374 x 0.472 inch)				mm
case material	plastic (UL94-V0)				
weight			4.9		g

MECHANICAL DRAWING

units: mm[inch]
 tolerance: ±0.25[±0.010]
 pin section tolerance: ±0.10[±0.004]

PIN CONNECTIONS		
PIN	Single Output	Dual Output
1	GND	GND
2	Vin	Vin
3	CTRL	CTRL
5	NC	NC
6	+Vo	+Vo
7	0V	0V
8	CS	-Vo

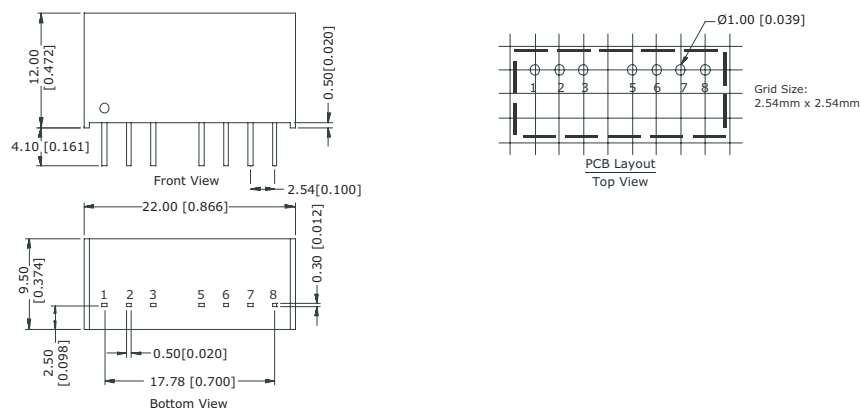

NC: No Connection

DERATING CURVES

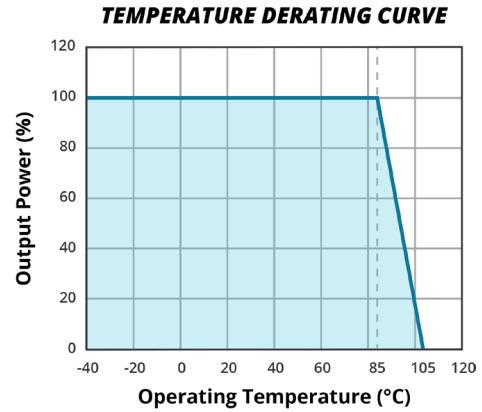
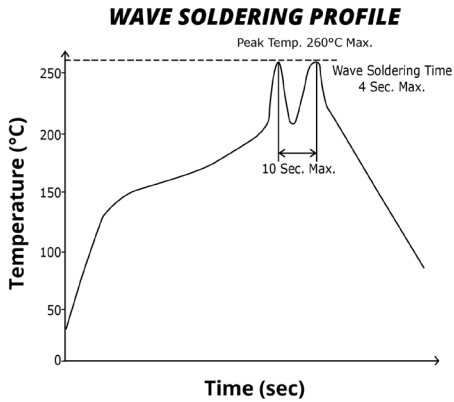

EMC RECOMMENDED CIRCUIT

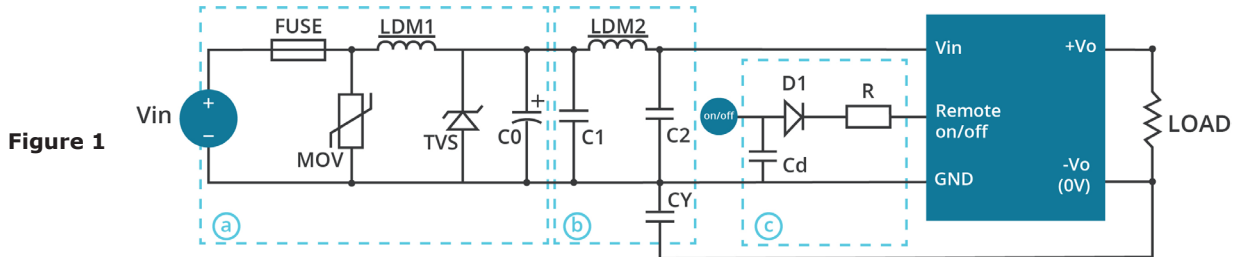

Figure 1

Recommended external circuit components				
Vin (Vdc)	5	12	24	48
FUSE	choose according to practical input current			
MOV	--	--	10D560	10D101
LDM1	--	--	56μH	56μH
TVS	SMCJ13A	SMCJ28A	SMCJ48A	SMCJ90A
C0	680μF/16V	680μF/25V	120μF/50V	120μF/100V
C1	4.7μF/50V	4.7μF/50V	4.7μF/50V	4.7μF/100V
LDM2	12μH	12μH	12μH	12μH
C2	4.7μF/50V	4.7μF/50V	4.7μF/50V	4.7μF/100V
CY	1nF/3kV	1nF/3kV	1nF/3kV	1nF/3kV
D1	RB160M-60/1A	RB160M-60/1A	RB160M-60/1A	RB160M-60/1A
R	Follows: $R = \frac{V_C - V_D - 1.0}{I_C} - 300$			
Cd	47nF/100V	47nF/100V	47nF/100V	47nF/100V

Table 1

Note: Figure 1-c is on/off control circuit. See page 6 for details.

TEST CONFIGURATION

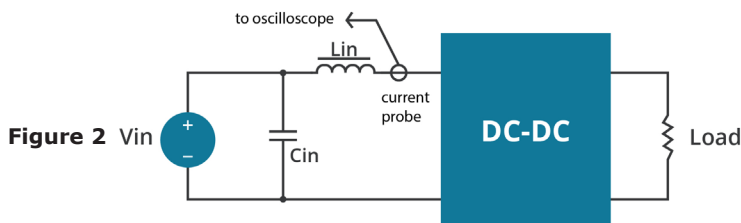

Figure 2

Table 2

External components	
Lin	4.7μH
Cin	220μF, ESR < 1.0Ω at 100 KHz

Note: Input reflected-ripple current is measured with an inductor Lin and Capacitor Cin to simulate source impedance.

APPLICATION NOTES

1. Output load requirement

To ensure this module can operate efficiently and reliably, the minimum output load may not be less than 5% of the full load during operation. If the actual output power is low, connect a resistor at the output end in parallel to increase the load.

2. Recommended circuit

This series has been tested according to the following recommended testing circuit before leaving the factory. This series should be tested under load (see Figure 3 and Table 3). If you want to further decrease the input/output ripple, you can increase the capacitance accordingly or choose capacitors with low ESR. However, the capacitance of the output filter capacitor must be appropriate. If the capacitance is too high, a startup problem might arise. For every channel of the output, to ensure safe and reliable operation, the maximum capacitance must be less than the maximum capacitive load (see Table 4).



Figure 3

Table 3

Vin (Vdc)	Cin1 (μF)	Cin2 (μF)	Lin (μH)	Cs ¹ (μF)	Cout (μF)	Lout ² (μH)	Cd (nF/V)
5	100	47	4.7~12	10~22	100	2.2~10	47/100
12	100	47	4.7~12	10~22	100	2.2~10	47/100
24	10	1	4.7~12	10~22	100	2.2~10	47/100
48	10	1	4.7~12	10~22	100	2.2~10	47/100

Note: 1. For single output only
2. For dual output only

Table 4

Single Vout (Vdc)	Max. Capacitive Load (μF)	Dual Vout (Vdc)	Max. Capacitive Load ¹ (μF)
3.3	2700	--	--
5	2200	5	1000
9	1000	--	--
12	680	12	470
15	470	15	330
24	330	--	--

Note: 1. For each output.

3. CTRL Terminal

When open or applied high impedance, the converter will turn on. When it's pulled high, the converter will shutdown. The input current should be between 5~10mA. Exceeding the maximum 20mA will cause permanent damage to the converter. The value for R can be derived as follows:

$$R = \frac{V_c - V_D - 1.0}{I_c} - 300$$

V_c: Control pin input voltage
V_D: Forward voltage drop of diode D1
I_c: Input current to control pin
R: Resistor of control circuit

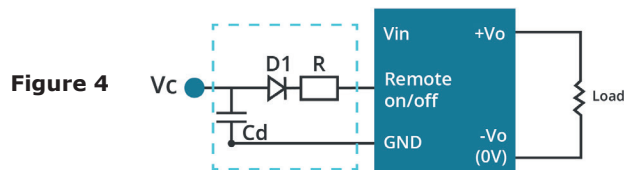

Figure 4

4. Input Current

When it is used in an unregulated condition, make sure that the input fluctuations and ripple voltage do not exceed the module standard. Refer to Figure 5 and Table 5 for the startup current of this dc-dc module.

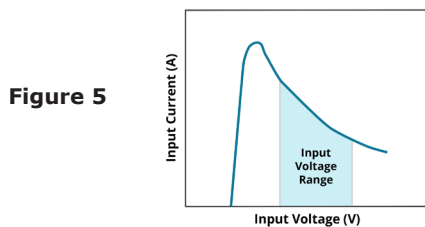

Figure 5

Table 5

Vin (Vdc)	I _p (mA)
5	1110
12	640
24	325
48	160

Note: 1. Minimum load shouldn't be less than 5%, otherwise ripple may increase dramatically. Operation under minimum load will not damage the converter, however, they may not meet all specifications listed.
2. Maximum capacitive load is tested at input voltage range and full load.
3. All specifications are measured at Ta=25°C, humidity<75%, nominal input voltage and rated output load unless otherwise specified.

REVISION HISTORY

rev.	description	date
1.0	initial release	05/05/2014
1.01	safeties updated in features and safety approvals line	01/19/2021
1.02	derating curve and circuit figures updated	11/15/2021
1.03	CE certification updated for 5, 12, 24V models	12/06/2022

The revision history provided is for informational purposes only and is believed to be accurate.



CUI INC

a bel group

Headquarters
20050 SW 112th Ave.
Tualatin, OR 97062
800.275.4899

Fax 503.612.2383
cui.com
techsupport@cui.com

CUI offers a two (2) year limited warranty. Complete warranty information is listed on our website.

CUI reserves the right to make changes to the product at any time without notice. Information provided by CUI is believed to be accurate and reliable. However, no responsibility is assumed by CUI for its use, nor for any infringements of patents or other rights of third parties which may result from its use.

CUI products are not authorized or warranted for use as critical components in equipment that requires an extremely high level of reliability. A critical component is any component of a life support device or system whose failure to perform can be reasonably expected to cause the failure of the life support device or system, or to affect its safety or effectiveness.