

SERIES: PBO-15C | **DESCRIPTION:** INTERNAL AC-DC POWER SUPPLY

FEATURES

- wide input range (85~305 VAC or 100 – 430 VDC)
- available in straight-pin and bent-pin configurations
- wide operating temperature range (-40 to +85 C)
- over-voltage, over-current, short-circuit protection
- IEC/EN/UL 62368 certified
- designed to meet IEC/EN/UL 60335 requirements
- safety class II
- ideal for Industrial Control & Smart Home applications

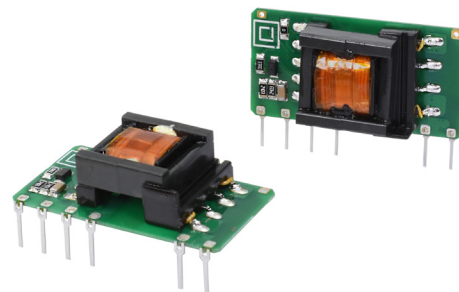

MODEL	output voltage	output current	output power	ripple and noise ¹	efficiency ²
	(Vdc)	max (A)	max (W)	typ (mVp-p)	typ (%)
PBO-15C-3	3.3	3.0	9.9	150	75.0
PBO-15C-5	5.0	2.8	14.0	150	77.0
PBO-15C-9	9.0	1.67	15.0	150	82.0
PBO-15C-12	12.0	1.25	15.0	150	82.0
PBO-15C-15	15.0	1.0	15.0	150	84.0
PBO-15C-24	24.0	0.625	15.0	150	85.0

Note: 1. At full load, nominal input, 20 MHz bandwidth oscilloscope, see Application Circuit.
2. At 230 Vac input.

PART NUMBER KEY

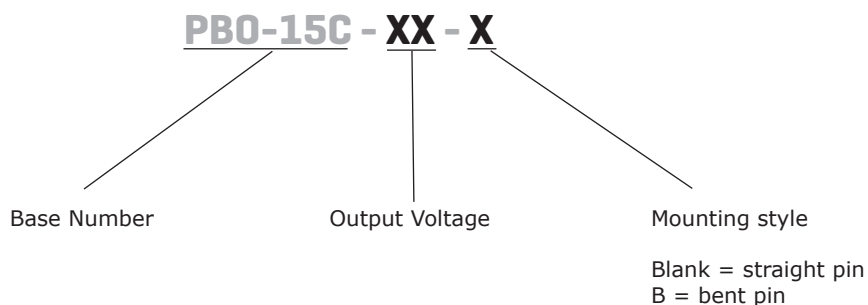

INPUT

parameter	conditions/description	min	typ	max	units
voltage	AC input	85		305	Vac
	DC input	100		430	Vdc
frequency		47		63	Hz
current	at 115 Vac			0.4	A
	at 230 Vac			0.25	A
inrush current	at 115 Vac		18		A
	at 230 Vac		35		A
no load power consumption	at 230 Vac			0.25	W

OUTPUT

parameter	conditions/description	min	typ	max	units
capacitive load	3.3 Vdc output models			20,000	μF
	5 Vdc output models			15,000	μF
	9 Vdc output models			5,000	μF
	12 Vdc output models			4,000	μF
	15 Vdc output models			2,000	μF
	24 Vdc output models			1,000	μF
initial set point accuracy	3.3 Vdc output		±3		%
	other outputs		±2		%
line regulation	at full load		±0.5		%
load regulation	0% ~ 100% load, 3.3 Vdc output		±2		%
	0% ~ 100% load, 5 Vdc output		±1.5		%
	0% ~ 100% load, other outputs		±1		%
hold-up time	at 115 Vac		10		ms
	at 230 Vac		40		ms
switching frequency			65		kHz
temperature coefficient			±0.02		%/°C

PROTECTIONS

parameter	conditions/description	min	typ	max	units
over voltage protection	output voltage clamp				
	3.3 & 5 Vdc output models			9.0	Vdc
	9 Vdc output models			12.0	Vdc
	12 Vdc output models			16.0	Vdc
	15 Vdc output models			20.0	Vdc
	24 Vdc output models			30.0	Vdc
over current protection	auto recovery	110			%
short circuit protection	continuous, auto recovery				

SAFETY & COMPLIANCE

parameter	conditions/description	min	typ	max	units
isolation voltage	input to output for 1 minute, leakage current <5mA	3,000			Vac
safety approvals	certified to 62368: IEC, EN, UL				
	designed to meet 60335: IEC, EN, UL				
safety class	class II				
EMI/EMC	CISPR32/EN55032 CLASS A (Recommended circuit 1, 4)				
	CISPR32/EN55032 CLASS B (Recommended circuit 2, 3)				
ESD	IEC/EN 61000-4-2 Contact ±6kV perf. criteria B				
radiated immunity	IEC/EN61000-4-3 10V/m perf. criteria A				

SAFETY & COMPLIANCE (CONTINUED)

parameter	conditions/description	min	typ	max	units
EFT/burst	IEC/EN61000-4-4 ±2KV (Recommended circuit 1, 2) perf. criteria B IEC/EN61000-4-4 ±4KV (Recommended circuit 3, 4) perf. criteria B				
surge	IEC/EN61000-4-5 line to line ±1KV (Recommended circuit 1, 2) perf. criteria B IEC/EN61000-4-5 line to line±2KV (Recommended circuit 3, 4) perf. criteria B				
conducted immunity	IEC/EN61000-4-6 10Vr.m.s perf. criteria A				
voltage dips and interruptions	IEC/EN61000-4-11 0%, 70% perf. criteria B				
MTBF	as per MIL-HDBK-217F at 25 °C	1,000,000			hours
RoHS	yes				

ENVIRONMENTAL

parameter	conditions/description	min	typ	max	units
operating temperature		-40		85	°C
storage temperature		-40		105	°C
storage humidity				95	%

SOLDERABILITY

parameter	conditions/description	min	typ	max	units
wave soldering	for 5~10 seconds	255	260	265	°C
manual welding	for 3~5 seconds	350	360	370	°C

DERATING CURVE

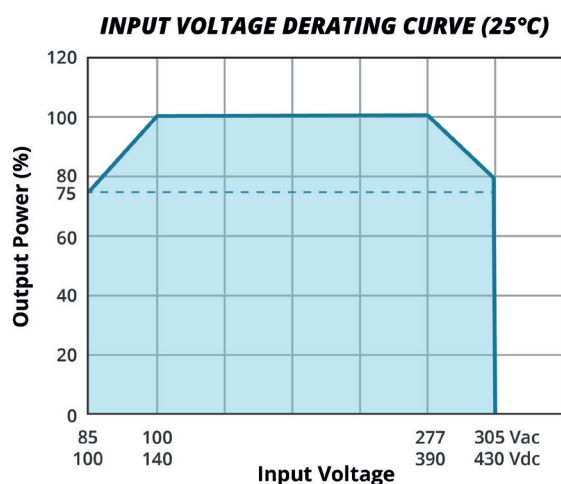
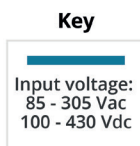
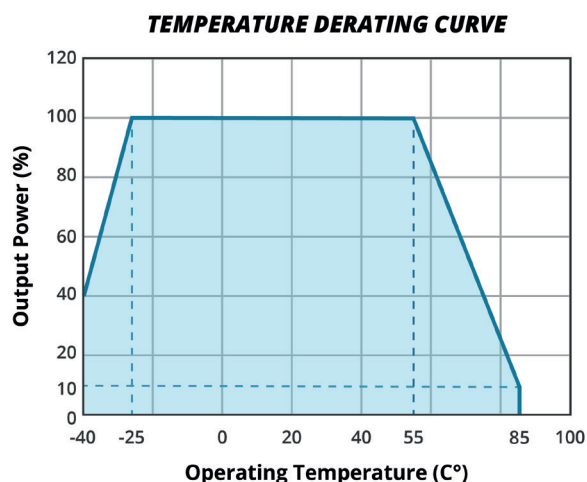

MECHANICAL

parameter	conditions/description	min	typ	max	units
dimensions	44.50 x 24.00 x 15.00 mm (1.751 x 0.944 x 0.590 inches)				inch
weight			11		g
cooling	free air convection				

MECHANICAL DRAWING

Straight-pin configuration

units: mm [inch]
 pin section tolerance: ± 0.10 [± 0.004]
 general tolerance: ± 0.50 [± 0.020]

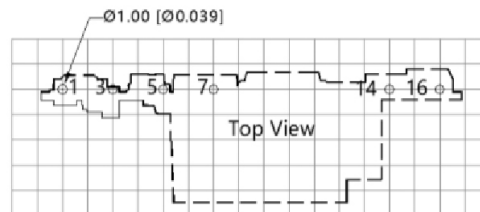
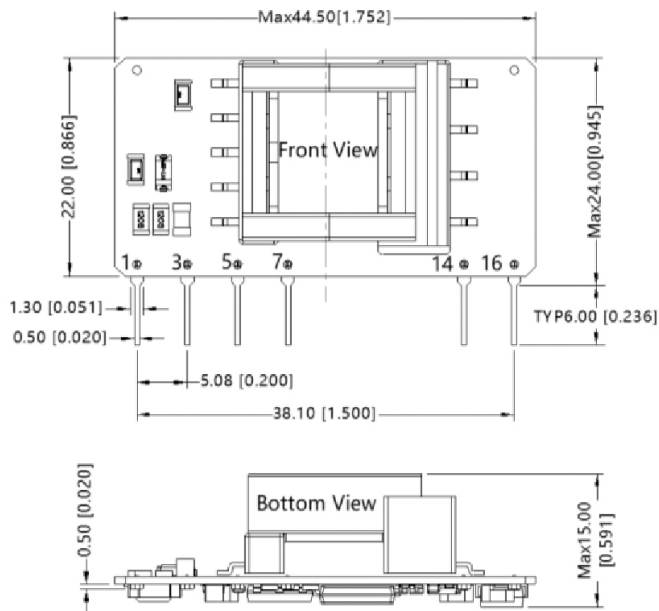

Note: Grid 2.54*2.54mm

Note: The separation between all primary and secondary circuits must be maintained as follows to maintain the safety requirements:
 Creepage: >6.4 mm
 Clearance: >4.0 mm

PIN CONNECTIONS	
PIN	Function
1	AC (N)
3	AC (L)
5	+V (cap)
7	-V (cap)
14	-Vo
16	+Vo

Bent-pin configuration

units: mm [inch]
 pin section tolerance: ± 0.10 [± 0.004]
 general tolerance: ± 0.50 [± 0.020]

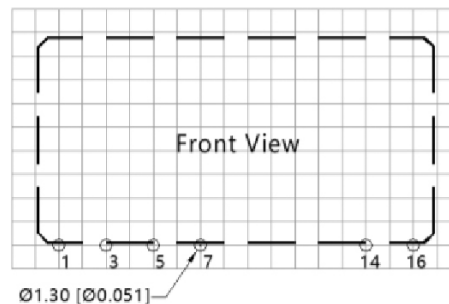
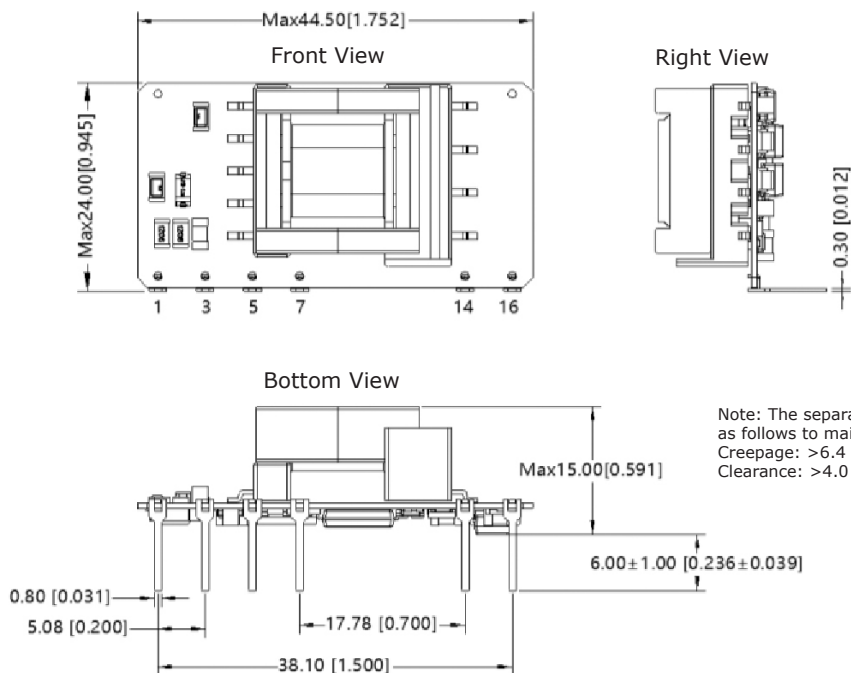

Note: Grid 2.54*2.54mm

Note: The separation between all primary and secondary circuits must be maintained as follows to maintain the safety requirements:
 Creepage: >6.4 mm
 Clearance: >4.0 mm

PIN CONNECTIONS	
PIN	Function
1	AC (N)
3	AC (L)
5	+V (cap)
7	-V (cap)
14	-Vo
16	+Vo

APPLICATION DESIGN REFERENCE

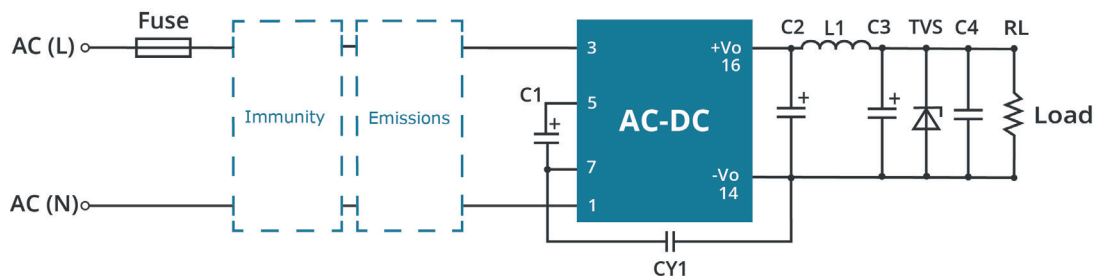

Note: All applications must follow this minimum circuit implementation. Additional environmental and application-specific variations are listed in the following pages.

PBO-15C Series additional component selection guide

Part no.	FUSE (required)	C1 (required)	C2 (required)	L1 (required)	C3 ¹ (required)	C4	CY1 (required)	TVS
PBO-15C-3	1A/300V	33μF/450V	470μF/16V (solid-state capacitor)	2.2μH (Max 22mΩ)	220μF/16V	0.1μF/50V	2.2nF/400Vac	SMBJ7.0A
PBO-15C-5								SMBJ7.0A
PBO-15C-9								SMBJ12A
PBO-15C-12			SMBJ20A					
PBO-15C-15			SMBJ20A					
PBO-15C-24			SMBJ30A					

Note: 1. C3 is recommended to be a high frequency electrolytic capacitor with low ESR.

PBO-15C Series Environmental and EMC selection guide

Recommended circuit	Typical application	Input voltage range	Environment temperature	Emissions	Immunity
1	General purpose	85~305Vac	-40°C to 85°C	Class A	Class III
2	Smart home, home appliances, intelligent building, intelligent agriculture		-25°C to 55°C	Class B	Class III
3	Indoor industrial		-25°C to 55°C	Class B	Class IV
4	Outdoor, video monitoring, charging point, communications, security		-40°C to 85°C	Class A	Class IV

Circuit 1

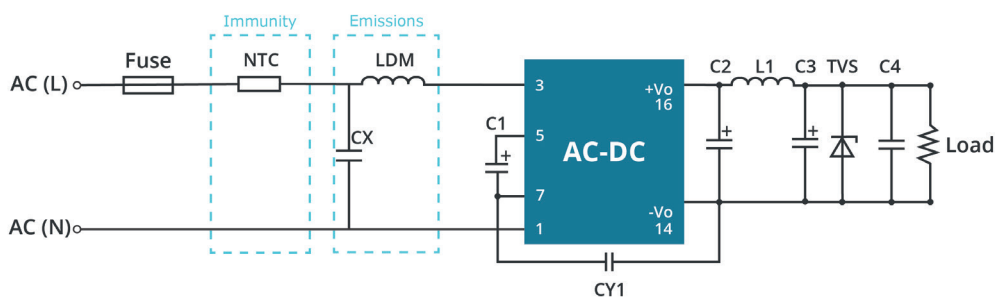

Table 1

Ambient temperature range	Imunity Class	Emissions Class
-40°C ~ 85°C	Class III	Class A

Component	Recommended value
NTC	10D - 10
LDM	1.2mH (min: 0.4A, max: 4Ω)
CX	0.1μF/310Vac
FUSE (required)	1A/300V, slow blow

Circuit 2

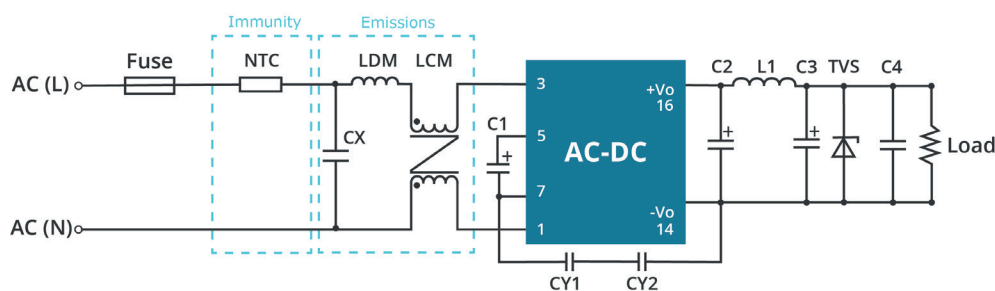

Table 2

Ambient temperature range	Imunity Class	Emissions Class
-25°C ~ 55°C	Class III	Class B

Component	Recommended value
NTC	10D - 10
CY1 (CY2)	2.2nF/400Vac
LCM	10mH (min: 0.4A, max: 600mΩ)
LDM	0.33mH (min: 0.4A, max: 1Ω)
CX	0.22μF/310Vac
FUSE (required)	1A/300V, slow blow

Note: When designing applications for household use (e.g. Smart Home or Home Appliance application), two Y-Caps (CY1 & CY2 valued at 2.2nF/400Vac each) are required in series to satisfy 60335 household safety requirements. Non-household applications can use one Y-Cap (CY1 valued at 2.2 nF/400Vac).

APPLICATION DESIGN REFERENCE (CONTINUED)

Circuit 3

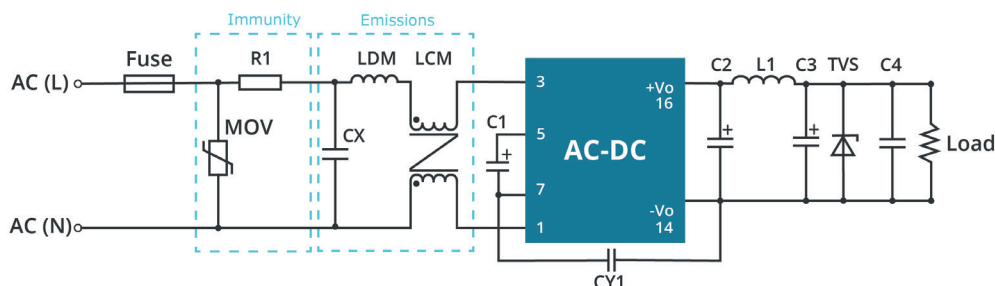

Table 3

Ambient temperature range	Immunity Class	Emissions Class
-25°C ~ 55°C	Class IV	Class B

Component	Recommended value
MOV	S14K350
CY1	2.2nF/400Vac
CX	0.22μF/310Vac
LCM	10mH (min: 0.4A, max: 600mΩ)
LDM	0.33mH (min: 0.4A, max: 1Ω)
R1	12Ω/3W
FUSE (required)	2A/300V, slow blow

Circuit 4

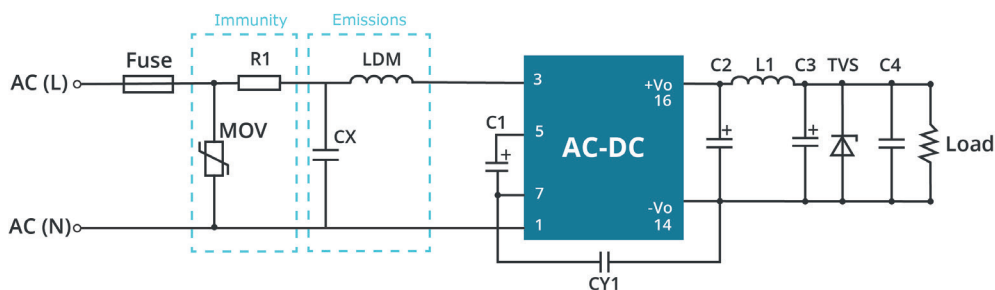

Table 4

Ambient temperature range	Immunity Class	Emissions Class
-40°C ~ 85°C	Class IV	Class A

Component	Recommended value
MOV	S14K350
LDM	1.2mH (min: 0.4A, max: 4Ω)
CX	0.1μF/310Vac
R1	12Ω/3W
FUSE (required)	2A/300V, slow blow

REVISION HISTORY

rev.	description	date
1.0	initial release	08/25/2020
1.01	datasheet update	12/14/2020
1.02	derating curves and circuit figures updated	01/24/2022

The revision history provided is for informational purposes only and is believed to be accurate.



Headquarters
20050 SW 112th Ave.
Tualatin, OR 97062
800.275.4899

Fax 503.612.2383
cui.com
techsupport@cui.com

CUI offers a two (2) year limited warranty. Complete warranty information is listed on our website.

CUI reserves the right to make changes to the product at any time without notice. Information provided by CUI is believed to be accurate and reliable. However, no responsibility is assumed by CUI for its use, nor for any infringements of patents or other rights of third parties which may result from its use.

CUI products are not authorized or warranted for use as critical components in equipment that requires an extremely high level of reliability. A critical component is any component of a life support device or system whose failure to perform can be reasonably expected to cause the failure of the life support device or system, or to affect its safety or effectiveness.