

## OPA2313-Q1 Low-Power, Rail-to-Rail In/Out, 500- $\mu$ V Typical Offset, 1-MHz Operational Amplifier for Cost-Sensitive Systems

### 1 Features

- AEC-Q100 Qualified for Automotive Applications
  - Device Temperature Grade 1:  $-40^{\circ}\text{C}$  to  $+125^{\circ}\text{C}$   $T_A$
- Precision Amplifier for Cost-Sensitive Systems
- Low  $I_Q$ : 50  $\mu\text{A}/\text{ch}$
- Wide Supply Range: 1.8 V to 5.5 V
- Low Noise: 25  $\text{nV}/\sqrt{\text{Hz}}$  at 1 kHz
- Gain Bandwidth: 1 MHz
- Rail-to-Rail Input/Output
- Low Input Bias Current: 0.2 pA
- Low Offset Voltage: 0.5 mV
- Unity-Gain Stable
- Internal RFI/EMI Filter

### 2 Applications

- Infotainment
- Engine Control Unit
- Automotive Lighting
- Low-Side Sensing
- Battery Management Systems
- Passive Safety
- Capacitive Sensing
- Fuel Pumps

### 3 Description

The OPA2313-Q1 dual-channel operational amplifier combines low power consumption with good performance. This enables it to be used in a wide range of applications, such as infotainment, engine control units, automotive lighting and more. The OPA2313-Q1 features rail-to-rail input and output (RRIO) swings, low quiescent current (50  $\mu\text{A}$ , typical), wide bandwidth (1 MHz) and very low noise (25  $\text{nV}/\sqrt{\text{Hz}}$  at 1 kHz), making it attractive for a variety of applications that require a good balance between cost and performance. Furthermore, low input bias current enables this device to be used in applications with megaohm source impedances.

The robust design of the OPA2313-Q1 provides ease-of-use to the circuit designer: unity-gain stability with capacitive loads of up to 150 pF, integrated RFI/EMI rejection filter, no phase reversal in overdrive conditions, and high electrostatic discharge (ESD) protection (4-kV HBM).

The device is optimized for operation at voltages as low as 1.8 V ( $\pm 0.9$  V) and up to 5.5 V ( $\pm 2.75$  V), and is specified over the extended temperature range of  $-40^{\circ}\text{C}$  to  $+125^{\circ}\text{C}$ .

#### Device Information<sup>(1)</sup>

PART NUMBER	PACKAGE	BODY SIZE (NOM)
OPA2313-Q1	SOIC (8)	4.90 mm x 3.91 mm
	VSSOP (8)	3.00 mm x 3.00 mm

(1) For all available packages, see the orderable addendum at the end of the data sheet.

#### EMIRR IN+ vs Frequency

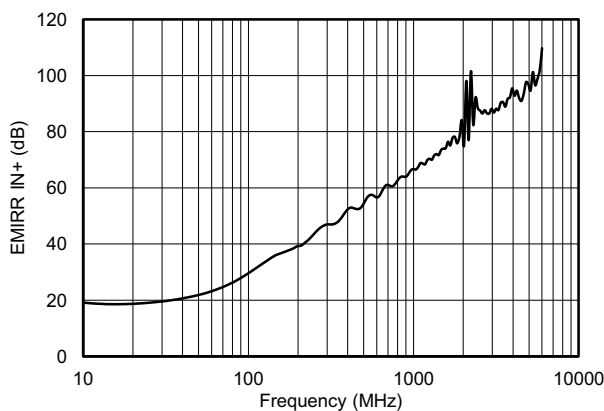

## Table of Contents

<b>1 Features</b> .....	<b>1</b>	7.4 Device Functional Modes.....	<b>18</b>
<b>2 Applications</b> .....	<b>1</b>	<b>8 Application and Implementation</b> .....	<b>19</b>
<b>3 Description</b> .....	<b>1</b>	8.1 Application Information.....	<b>19</b>
<b>4 Revision History</b> .....	<b>2</b>	8.2 Typical Application .....	<b>19</b>
<b>5 Pin Configuration and Functions</b> .....	<b>3</b>	8.3 System Examples .....	<b>20</b>
<b>6 Specifications</b> .....	<b>4</b>	<b>9 Power Supply Recommendations</b> .....	<b>21</b>
6.1 Absolute Maximum Ratings .....	4	<b>10 Layout</b> .....	<b>22</b>
6.2 ESD Ratings.....	4	10.1 Layout Guidelines .....	22
6.3 Recommended Operating Conditions.....	4	10.2 Layout Example .....	22
6.4 Thermal Information .....	4	<b>11 Device and Documentation Support</b> .....	<b>23</b>
6.5 Electrical Characteristics: 5.5 V .....	5	11.1 Documentation Support .....	23
6.6 Electrical Characteristics: 1.8 V .....	7	11.2 Receiving Notification of Documentation Updates	23
6.7 Typical Characteristics: Tables of Graphs .....	9	11.3 Community Resources.....	23
6.8 Typical Characteristics.....	10	11.4 Trademarks .....	23
<b>7 Detailed Description</b> .....	<b>16</b>	11.5 Electrostatic Discharge Caution.....	23
7.1 Overview .....	16	11.6 Glossary .....	23
7.2 Functional Block Diagram .....	16	<b>12 Mechanical, Packaging, and Orderable</b>	
7.3 Feature Description.....	17	<b>Information</b> .....	<b>23</b>

## 4 Revision History

DATE	REVISION	NOTES
December 2018	*	Initial release.

## 5 Pin Configuration and Functions

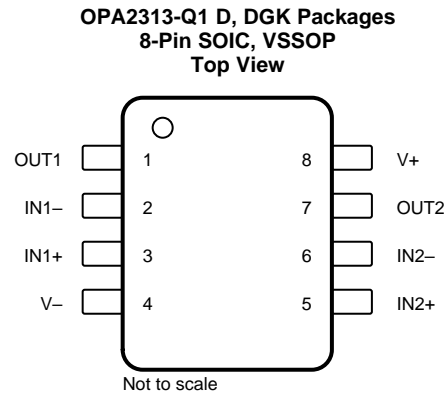

**Pin Functions: OPA2313-Q1**

PIN		I/O	DESCRIPTION
NAME	NO.		
IN1-	2	I	Inverting input, channel 1
IN1+	3	I	Noninverting input, channel 1
IN2-	6	I	Inverting input, channel 2
IN2+	5	I	Noninverting input, channel 2
OUT1	1	O	Output, channel 1
OUT2	7	O	Output, channel 2
V-	4	—	Negative (lowest) supply or ground (for single-supply operation)
V+	8	—	Positive (highest) supply

## 6 Specifications

### 6.1 Absolute Maximum Ratings

over operating free-air temperature range (unless otherwise noted)<sup>(1)</sup>

		MIN	MAX	UNIT
Voltage	Supply voltage (V+) – (V–)	0	7	V
	Signal input terminals <sup>(2)</sup>	(V–) – (0.5)	(V+) + 0.5	
Current	Signal input terminals <sup>(2)</sup>	–10	10	mA
	Output short circuit <sup>(3)</sup>	Continuous		
Temperature	Operating, T <sub>A</sub>	–40	150	°C
	Junction, T <sub>J</sub>		150	
	Storage, T <sub>stg</sub>	–65	150	

- (1) Stresses beyond those listed under *Absolute Maximum Ratings* may cause permanent damage to the device. These are stress ratings only, which do not imply functional operation of the device at these or any other conditions beyond those indicated under *Recommended Operating Conditions*. Exposure to absolute-maximum-rated conditions for extended periods may affect device reliability.
- (2) Input pins are diode-clamped to the power-supply rails. Input signals that may swing more than 0.5 V beyond the supply rails must be current limited to 10 mA or less.
- (3) Short-circuit to ground, one amplifier per package.

### 6.2 ESD Ratings

		VALUE	UNIT
V <sub>(ESD)</sub> Electrostatic discharge	Human-body model (HBM), per ANSI/ESDA/JEDEC JS-001 <sup>(1)</sup> HBM ESD Classification Level 3A	±4000	V
	Charged-device model (CDM), per JEDEC specification JESD22-C101 <sup>(2)</sup> CDM ESD Classification Level C6	±1000	

- (1) JEDEC document JEP155 states that 500-V HBM allows safe manufacturing with a standard ESD control process.
- (2) JEDEC document JEP157 states that 250-V CDM allows safe manufacturing with a standard ESD control process.

### 6.3 Recommended Operating Conditions

over operating free-air temperature range (unless otherwise noted)

		MIN	MAX	UNIT
V <sub>S</sub>	Supply voltage (V+) – (V–)	1.8	5.5	V
T <sub>A</sub>	Specified temperature	–40	125	°C

### 6.4 Thermal Information

THERMAL METRIC <sup>(1)</sup>		OPA2313-Q1		UNIT
		D (SOIC)	DGK (VSSOP)	
		8 Pins	8 Pins	
R <sub>θJA</sub>	Junction-to-ambient thermal resistance	138.4	191.2	°C/W
R <sub>θJC(top)</sub>	Junction-to-case (top) thermal resistance	89.5	61.9	°C/W
R <sub>θJB</sub>	Junction-to-board thermal resistance	78.6	111.9	°C/W
ψ <sub>JT</sub>	Junction-to-top characterization parameter	29.9	5.1	°C/W
ψ <sub>JB</sub>	Junction-to-board characterization parameter	78.1	110.2	°C/W

- (1) For more information about traditional and new thermal metrics, see the [Semiconductor and IC Package Thermal Metrics](#) application report.

## 6.5 Electrical Characteristics: 5.5 V<sup>(1)</sup>

For  $V_S = (V+) - (V-) = 5.5\text{ V}$  at  $T_A = 25^\circ\text{C}$ ,  $R_L = 10\text{ k}\Omega$  connected to  $V_S / 2$ , and  $V_{CM} = V_{OUT} = V_S / 2$ , (unless otherwise noted)<sup>(1)</sup>

PARAMETER		TEST CONDITIONS	MIN	TYP	MAX	UNIT
<b>OFFSET VOLTAGE</b>						
$V_{OS}$	Input offset voltage			0.5	2.5	mV
$dV_{OS}/dT$	Input offset voltage vs temperature	$T_A = -40^\circ\text{C}$ to $125^\circ\text{C}$		2		$\mu\text{V}/^\circ\text{C}$
PSRR	Power-supply rejection ratio	$T_A = -40^\circ\text{C}$ to $125^\circ\text{C}$	74	90		dB
	Channel separation, dc	At dc		10		$\mu\text{V}/\text{V}$
<b>INPUT VOLTAGE RANGE</b>						
$V_{CM}$	Common-mode voltage range	No phase reversal, rail-to-rail input	$(V-) - 0.2$		$(V+) + 0.2$	V
CMRR	Common-mode rejection ratio	$(V-) - 0.2\text{ V} < V_{CM} < (V+) - 1.3\text{ V}$	$T_A = -40^\circ\text{C}$ to $125^\circ\text{C}$	70	85	dB
		$V_{CM} = -0.2\text{ V}$ to $5.7\text{ V}$	$T_A = -40^\circ\text{C}$ to $125^\circ\text{C}$	64	80	
<b>INPUT BIAS CURRENT</b>						
$I_B$	Input bias current			$\pm 0.2$	$\pm 10$	pA
			$T_A = -40^\circ\text{C}$ to $85^\circ\text{C}$ <sup>(2)</sup>		$\pm 50$	
			$T_A = -40^\circ\text{C}$ to $125^\circ\text{C}$ <sup>(2)</sup>		$\pm 600$	
$I_{OS}$	Input offset current			$\pm 0.2$	$\pm 10$	pA
			$T_A = -40^\circ\text{C}$ to $85^\circ\text{C}$ <sup>(2)</sup>		$\pm 50$	
			$T_A = -40^\circ\text{C}$ to $125^\circ\text{C}$ <sup>(2)</sup>		$\pm 600$	
<b>NOISE</b>						
	Input voltage noise (peak-to-peak)	$f = 0.1\text{ Hz}$ to $10\text{ Hz}$		6		$\mu\text{V}_{PP}$
$e_n$	Input voltage noise density	$f = 10\text{ kHz}$		22		$\text{nV}/\sqrt{\text{Hz}}$
		$f = 1\text{ kHz}$		25		
$i_n$	Input current noise density	$f = 1\text{ kHz}$		5		$\text{fA}/\sqrt{\text{Hz}}$
<b>INPUT CAPACITANCE</b>						
$C_{IN}$	Differential			1		pF
	Common-mode			5		
<b>OPEN-LOOP GAIN</b>						
$A_{OL}$	Open-loop voltage gain	$0.05\text{ V} < V_O < (V+) - 0.05\text{ V}$ , $R_L = 100\text{ k}\Omega$		90	104	dB
		$0.3\text{ V} < V_O < (V+) - 0.3\text{ V}$ , $R_L = 2\text{ k}\Omega$		100	110	
		$0.1\text{ V} < V_O < (V+) - 0.1\text{ V}$	$T_A = -40^\circ\text{C}$ to $125^\circ\text{C}$	104	116	
	Phase margin	$V_S = 5\text{ V}$ , $G = +1$		65		$^\circ$
<b>FREQUENCY RESPONSE</b>						
GBW	Gain-bandwidth product	$V_S = 5\text{ V}$ , $C_L = 10\text{ pF}$		1		MHz
SR	Slew rate	$V_S = 5\text{ V}$ , $G = +1$		0.5		$\text{V}/\mu\text{s}$
$t_S$	Settling time	To 0.1%, $V_S = 5\text{ V}$ , 2-V step, $G = +1$		5		$\mu\text{s}$
		To 0.01%, $V_S = 5\text{ V}$ , 2-V step, $G = +1$		6		
	Overload recovery time	$V_S = 5\text{ V}$ , $V_{IN} \times \text{Gain} > V_S$		3		
THD+N	Total harmonic distortion + noise <sup>(3)</sup>	$V_S = 5\text{ V}$ , $V_O = 1\text{ V}_{RMS}$ , $G = +1$ , $f = 1\text{ kHz}$		0.0045%		
<b>OUTPUT</b>						
$V_O$	Voltage output swing from supply rails	$R_L = 100\text{ k}\Omega$ <sup>(2)</sup>		5	20	mV
		$R_L = 100\text{ k}\Omega$ <sup>(2)</sup>	$T_A = -40^\circ\text{C}$ to $125^\circ\text{C}$		30	
		$R_L = 2\text{ k}\Omega$ <sup>(2)</sup>		75	100	
		$R_L = 2\text{ k}\Omega$ <sup>(2)</sup>	$T_A = -40^\circ\text{C}$ to $125^\circ\text{C}$		125	
$I_{SC}$	Short-circuit current			$\pm 15$		mA
			$T_A = -40^\circ\text{C}$ to $125^\circ\text{C}$		$\pm 12$	
$R_O$	Open-loop output impedance			2300		$\Omega$

(1) Parameters with minimum or maximum specification limits are 100% production tested at  $25^\circ\text{C}$ , unless otherwise noted. Over-temperature limits are based on characterization and statistical analysis.

(2) Specified by design and characterization; not production tested.

(3) Third-order filter; bandwidth = 80 kHz at  $-3\text{ dB}$ .

**Electrical Characteristics: 5.5 V<sup>(1)</sup> (continued)**

For  $V_S = (V+) - (V-) = 5.5\text{ V}$  at  $T_A = 25^\circ\text{C}$ ,  $R_L = 10\text{ k}\Omega$  connected to  $V_S / 2$ , and  $V_{CM} = V_{OUT} = V_S / 2$ , (unless otherwise noted)<sup>(1)</sup>

PARAMETER		TEST CONDITIONS	MIN	TYP	MAX	UNIT
<b>POWER SUPPLY</b>						
$V_S$	Specified voltage range		1.8 ( $\pm 0.9$ )		5.5 ( $\pm 2.75$ )	V
$I_Q$	Quiescent current per amplifier	$V_S = 5\text{ V}$ , $I_O = 0\text{ mA}$		50	60	$\mu\text{A}$
		$V_S = 5\text{ V}$ , $I_O = 0\text{ mA}$	$T_A = -40^\circ\text{C}$ to $125^\circ\text{C}$		85	
	Power-on time	$V_S = 0\text{ V}$ to $5\text{ V}$ , to 90% $I_Q$ level		10		$\mu\text{s}$

## 6.6 Electrical Characteristics: 1.8 V<sup>(1)</sup>

For  $V_S = (V+) - (V-) = 1.8\text{ V}$  at  $T_A = 25^\circ\text{C}$ ,  $R_L = 10\text{ k}\Omega$  connected to  $V_S / 2$ ,  $V_{CM} = V_{S+} - 1.3\text{ V}$ , and  $V_{OUT} = V_S / 2$ , (unless otherwise noted)<sup>(1)</sup>

PARAMETER		TEST CONDITIONS		MIN	TYP	MAX	UNIT
<b>OFFSET VOLTAGE</b>							
$V_{OS}$	Input offset voltage				0.5	2.5	mV
$dV_{OS}/dT$	Input offset voltage vs temperature		$T_A = -40^\circ\text{C}$ to $125^\circ\text{C}$		2		$\mu\text{V}/^\circ\text{C}$
PSRR	Power-supply rejection ratio		$T_A = -40^\circ\text{C}$ to $125^\circ\text{C}$	74	90		dB
	Channel separation, dc	At dc			10		$\mu\text{V}/\text{V}$
<b>INPUT VOLTAGE RANGE</b>							
$V_{CM}$	Common-mode voltage range	No phase reversal, rail-to-rail input		$(V-) - 0.2$		$(V+) + 0.2$	V
CMRR	Common-mode rejection ratio	$(V-) - 0.2\text{ V} < V_{CM} < (V+) - 1.3\text{ V}$	$T_A = -40^\circ\text{C}$ to $125^\circ\text{C}$	70	85		dB
		$V_S = 1.8\text{ V}$ , $V_{CM} = -0.2\text{ V}$ to $1.8\text{ V}$		58	73		
		$V_{CM} = -0.2\text{ V}$ to $1.6\text{ V}$	$T_A = -40^\circ\text{C}$ to $125^\circ\text{C}$	58	70		
<b>INPUT BIAS CURRENT</b>							
$I_B$	Input bias current				$\pm 0.2$	$\pm 10$	pA
			$T_A = -40^\circ\text{C}$ to $85^\circ\text{C}$ <sup>(2)</sup>			$\pm 50$	
			$T_A = -40^\circ\text{C}$ to $125^\circ\text{C}$ <sup>(2)</sup>			$\pm 600$	
$I_{OS}$	Input offset current				$\pm 0.2$	$\pm 10$	pA
			$T_A = -40^\circ\text{C}$ to $85^\circ\text{C}$ <sup>(2)</sup>			$\pm 50$	
			$T_A = -40^\circ\text{C}$ to $125^\circ\text{C}$ <sup>(2)</sup>			$\pm 600$	
<b>NOISE</b>							
	Input voltage noise (peak-to-peak)	$f = 0.1\text{ Hz}$ to $10\text{ Hz}$			6		$\mu\text{V}_{PP}$
$e_n$	Input voltage noise density	$f = 10\text{ kHz}$			22		$\text{nV}/\sqrt{\text{Hz}}$
		$f = 1\text{ kHz}$			25		
$i_n$	Input current noise density	$f = 1\text{ kHz}$			5		$\text{fA}/\sqrt{\text{Hz}}$
<b>INPUT CAPACITANCE</b>							
$C_{IN}$	Differential				1		pF
	Common-mode				5		
<b>OPEN-LOOP GAIN</b>							
$A_{OL}$	Open-loop voltage gain	$0.05\text{ V} < V_O < (V+) - 0.05\text{ V}$ , $R_L = 100\text{ k}\Omega$		100	110		dB
		$0.1\text{ V} < V_O < (V+) - 0.1\text{ V}$	$T_A = -40^\circ\text{C}$ to $125^\circ\text{C}$	90	110		
<b>FREQUENCY RESPONSE</b>							
GBW	Gain-bandwidth product	$C_L = 10\text{ pF}$			0.9		MHz
SR	Slew rate	$G = +1$			0.45		$\text{V}/\mu\text{s}$
$t_s$	Settling time	To 0.1%, $V_S = 5\text{ V}$ , 2-V step, $G = +1$			5		$\mu\text{s}$
		To 0.01%, $V_S = 5\text{ V}$ , 2-V step, $G = +1$			6		
	Overload recovery time	$V_S = 5\text{ V}$ , $V_{IN} \times \text{Gain} > V_S$			3		
THD+N	Total harmonic distortion + noise <sup>(3)</sup>	$V_S = 5\text{ V}$ , $V_O = 1\text{ V}_{RMS}$ , $G = +1$ , $f = 1\text{ kHz}$			0.0045%		
<b>OUTPUT</b>							
$V_O$	Voltage output swing from supply rails	$R_L = 100\text{ k}\Omega$ <sup>(2)</sup>			5	15	mV
		$R_L = 100\text{ k}\Omega$ <sup>(2)</sup>	$T_A = -40^\circ\text{C}$ to $125^\circ\text{C}$			30	
		$R_L = 2\text{ k}\Omega$ <sup>(2)</sup>			25	50	
		$R_L = 2\text{ k}\Omega$ <sup>(2)</sup>	$T_A = -40^\circ\text{C}$ to $125^\circ\text{C}$			125	
$I_{SC}$	Short-circuit current				$\pm 6$		mA
$R_O$	Open-loop output impedance				2300		$\Omega$

(1) Parameters with minimum or maximum specification limits are 100% production tested at  $25^\circ\text{C}$ , unless otherwise noted. Over-temperature limits are based on characterization and statistical analysis.

(2) Specified by design and characterization; not production tested.

(3) Third-order filter; bandwidth = 80 kHz at  $-3\text{ dB}$ .

**Electrical Characteristics: 1.8 V<sup>(1)</sup> (continued)**

For  $V_S = (V+) - (V-) = 1.8\text{ V}$  at  $T_A = 25^\circ\text{C}$ ,  $R_L = 10\text{ k}\Omega$  connected to  $V_S / 2$ ,  $V_{CM} = V_{S+} - 1.3\text{ V}$ , and  $V_{OUT} = V_S / 2$ , (unless otherwise noted)<sup>(1)</sup>

PARAMETER		TEST CONDITIONS	MIN	TYP	MAX	UNIT
<b>POWER SUPPLY</b>						
$V_S$	Specified voltage range		1.8 ( $\pm 0.9$ )		5.5 ( $\pm 2.75$ )	V
$I_Q$	Quiescent current per amplifier	$V_S = 5\text{ V}$ , $I_O = 0\text{ mA}$		50	60	$\mu\text{A}$
	Power-on time	$V_S = 0\text{ V}$ to $5\text{ V}$ , to 90% $I_Q$ level		10		$\mu\text{s}$



## 6.7 Typical Characteristics: Tables of Graphs

**Table 1. Characteristic Performance Measurements**

TITLE	FIGURE
Open-Loop Gain and Phase vs Frequency	<a href="#">Figure 1</a>
Open-Loop Gain vs Temperature	<a href="#">Figure 2</a>
Quiescent Current vs Supply Voltage	<a href="#">Figure 3</a>
Quiescent Current vs Temperature	<a href="#">Figure 4</a>
Offset Voltage Production Distribution	<a href="#">Figure 5</a>
Offset Voltage Drift Distribution	<a href="#">Figure 6</a>
Offset Voltage vs Common-Mode Voltage (Maximum Supply)	<a href="#">Figure 7</a>
Offset Voltage vs Temperature	<a href="#">Figure 8</a>
CMRR and PSRR vs Frequency (RTI)	<a href="#">Figure 9</a>
CMRR and PSRR vs Temperature	<a href="#">Figure 10</a>
0.1-Hz to 10-Hz Input Voltage Noise (5.5 V)	<a href="#">Figure 11</a>
Input Voltage Noise Spectral Density vs Frequency (1.8 V, 5.5 V)	<a href="#">Figure 12</a>
Input Voltage Noise vs Common-Mode Voltage (5.5 V)	<a href="#">Figure 13</a>
Input Bias and Offset Current vs Temperature	<a href="#">Figure 14</a>
Open-Loop Output Impedance vs Frequency	<a href="#">Figure 15</a>
Maximum Output Voltage vs Frequency and Supply Voltage	<a href="#">Figure 16</a>
Output Voltage Swing vs Output Current (over Temperature)	<a href="#">Figure 17</a>
Closed-Loop Gain vs Frequency, $G = 1, -1, 10$ (1.8 V)	<a href="#">Figure 18</a>
Closed-Loop Gain vs Frequency, $G = 1, -1, 10$ (5.5 V)	<a href="#">Figure 19</a>
Small-Signal Overshoot vs Load Capacitance	<a href="#">Figure 20</a>
Phase Margin vs Capacitive Load	<a href="#">Figure 21</a>
Small-Signal Step Response, Noninverting (1.8 V)	<a href="#">Figure 22</a>
Small-Signal Step Response, Noninverting ( 5.5 V)	<a href="#">Figure 23</a>
Large-Signal Step Response, Noninverting (1.8 V)	<a href="#">Figure 24</a>
Large-Signal Step Response, Noninverting ( 5.5 V)	<a href="#">Figure 25</a>
Positive Overload Recovery	<a href="#">Figure 26</a>
Negative Overload Recovery	<a href="#">Figure 27</a>
No Phase Reversal	<a href="#">Figure 28</a>
Channel Separation vs Frequency (Dual)	<a href="#">Figure 29</a>
THD+N vs Amplitude ( $G = +1, 2\text{ k}\Omega, 10\text{ k}\Omega$ )	<a href="#">Figure 30</a>
THD+N vs Amplitude ( $G = -1, 2\text{ k}\Omega, 10\text{ k}\Omega$ )	<a href="#">Figure 31</a>
THD+N vs Frequency (0.5 $V_{RMS}$ , $G = +1, 2\text{ k}\Omega, 10\text{ k}\Omega$ )	<a href="#">Figure 32</a>
EMIRR IN+ vs Frequency	<a href="#">Figure 33</a>

### 6.8 Typical Characteristics

At  $T_A = 25^\circ\text{C}$ ,  $V_S = 5\text{ V}$ ,  $R_L = 10\text{ k}\Omega$  connected to  $V_S / 2$ , and  $V_{CM} = V_{OUT} = V_S / 2$ , unless otherwise noted.

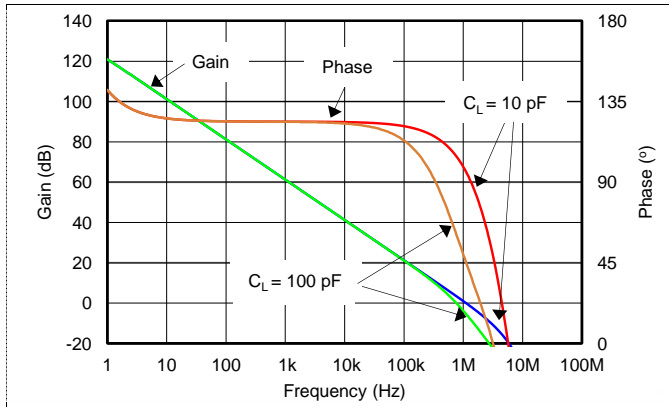

Figure 1. Open-Loop Gain and Phase vs Frequency

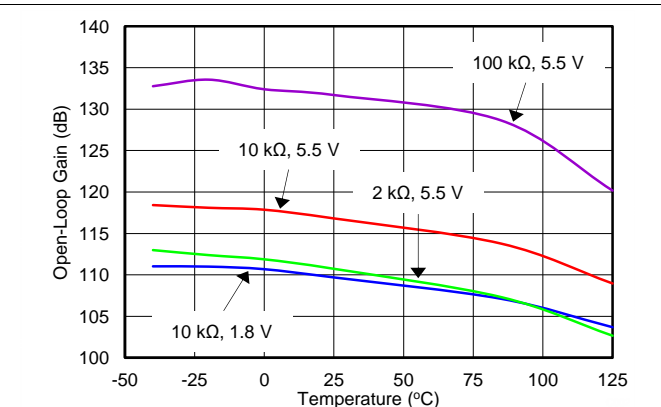

Figure 2. Open-Loop Gain vs Temperature

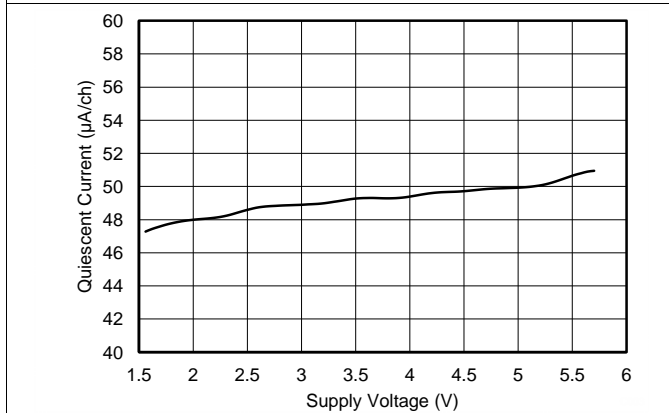

Figure 3. Quiescent Current vs Supply

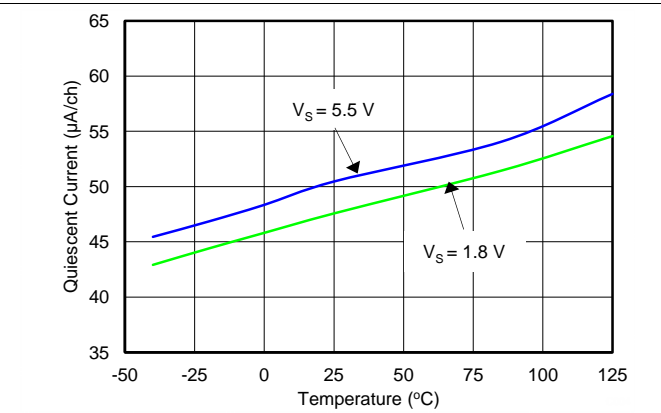

Figure 4. Quiescent Current vs Temperature

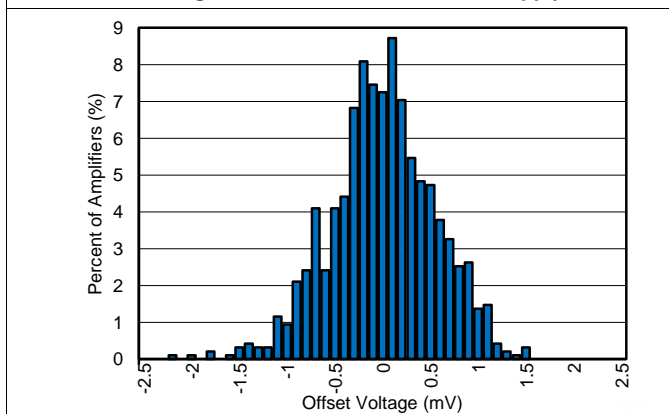

Figure 5. Offset Voltage Production Distribution

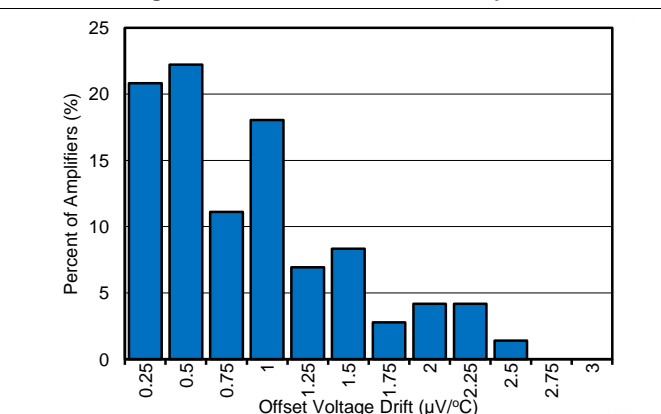

Figure 6. Offset Voltage Drift Distribution

### Typical Characteristics (continued)

At  $T_A = 25^\circ\text{C}$ ,  $V_S = 5\text{ V}$ ,  $R_L = 10\text{ k}\Omega$  connected to  $V_S / 2$ , and  $V_{CM} = V_{OUT} = V_S / 2$ , unless otherwise noted.

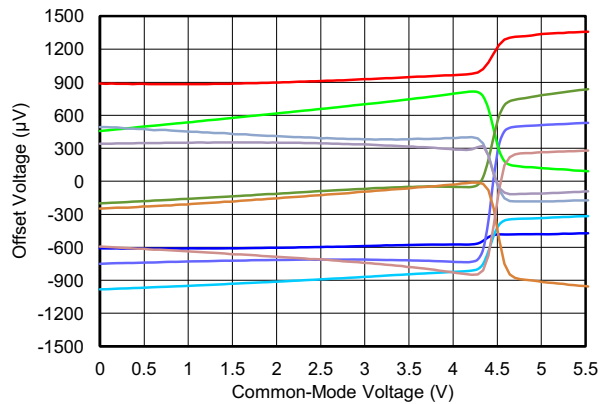

Figure 7. Offset Voltage vs Common-Mode Voltage

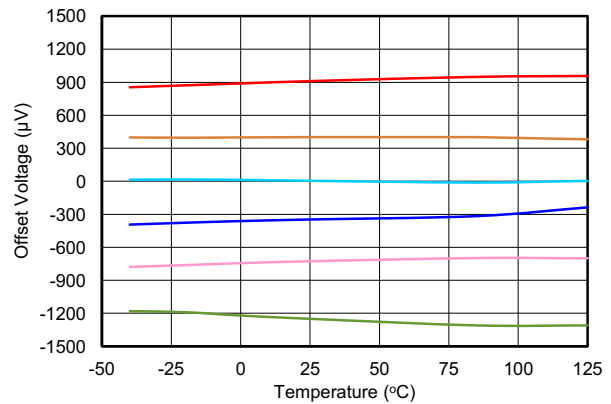

Figure 8. Offset Voltage vs Temperature

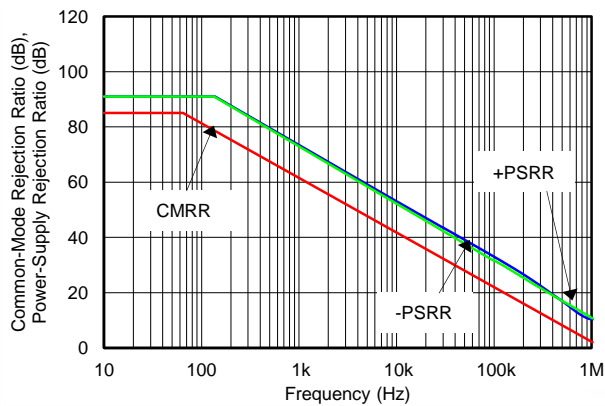

Figure 9. CMRR and PSRR vs Frequency (Referred-to-Input)

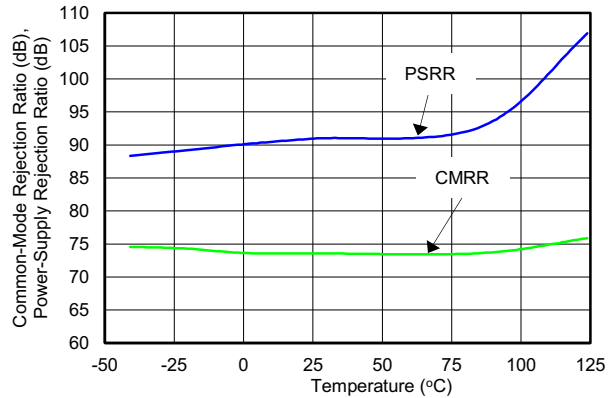

Figure 10. CMRR and PSRR vs Temperature

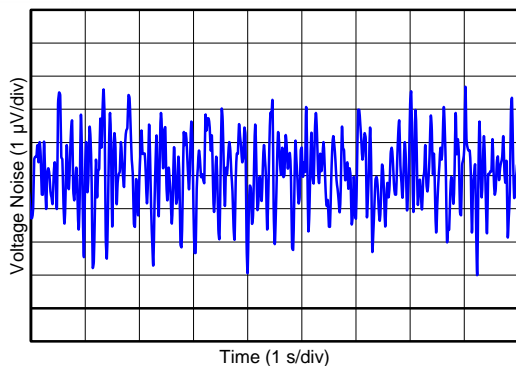

Figure 11. 0.1-Hz to 10-Hz Input Voltage Noise

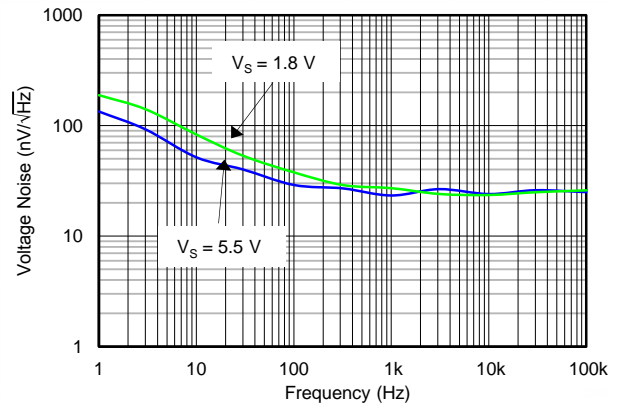

Figure 12. Input Voltage Noise Spectral Density vs Frequency

### Typical Characteristics (continued)

At  $T_A = 25^\circ\text{C}$ ,  $V_S = 5\text{ V}$ ,  $R_L = 10\text{ k}\Omega$  connected to  $V_S / 2$ , and  $V_{CM} = V_{OUT} = V_S / 2$ , unless otherwise noted.

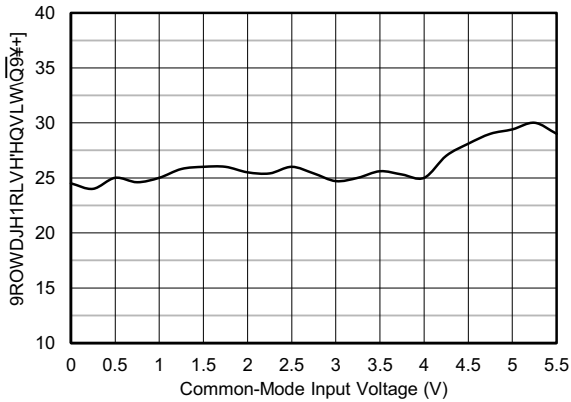

Figure 13. Voltage Noise vs Common-Mode Voltage

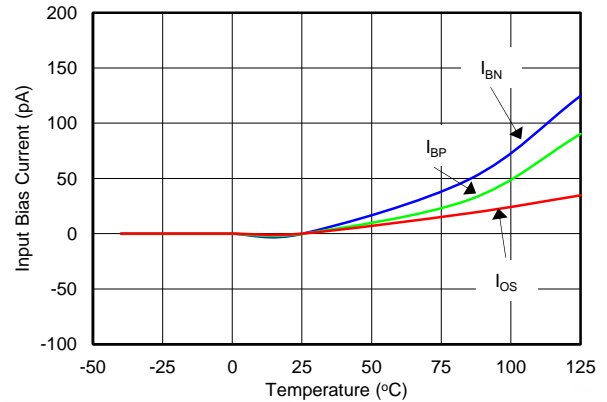

Figure 14. Input Bias and Offset Current vs Temperature

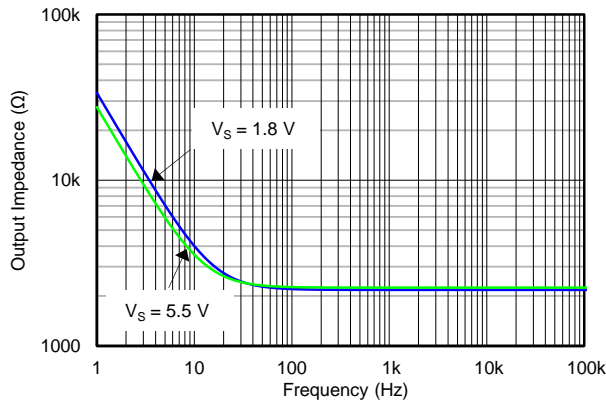

Figure 15. Open-Loop Output Impedance vs Frequency

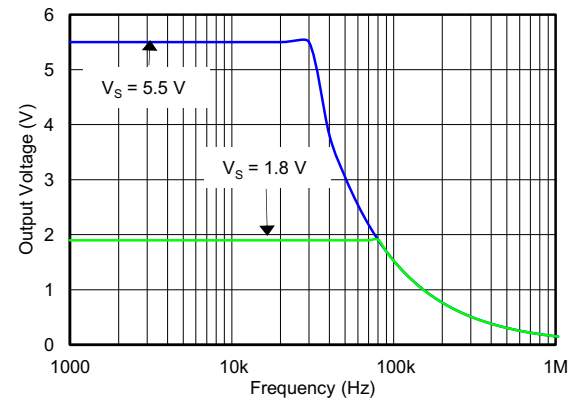

Figure 16. Maximum Output Voltage vs Frequency and Supply Voltage

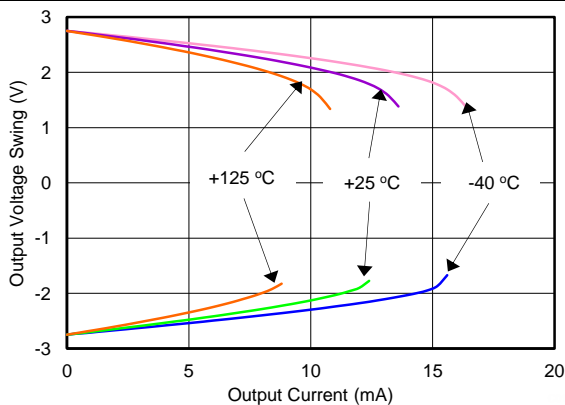

Figure 17. Output Voltage Swing vs Output Current (Over Temperature)

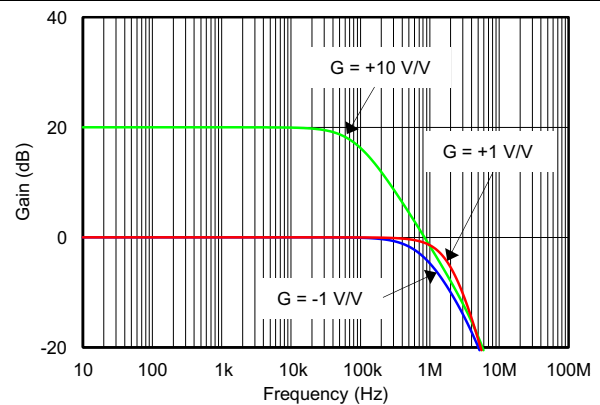

Figure 18. Closed-Loop Gain vs Frequency (Minimum Supply)

Typical Characteristics (continued)

At  $T_A = 25^\circ\text{C}$ ,  $V_S = 5\text{ V}$ ,  $R_L = 10\text{ k}\Omega$  connected to  $V_S / 2$ , and  $V_{CM} = V_{OUT} = V_S / 2$ , unless otherwise noted.

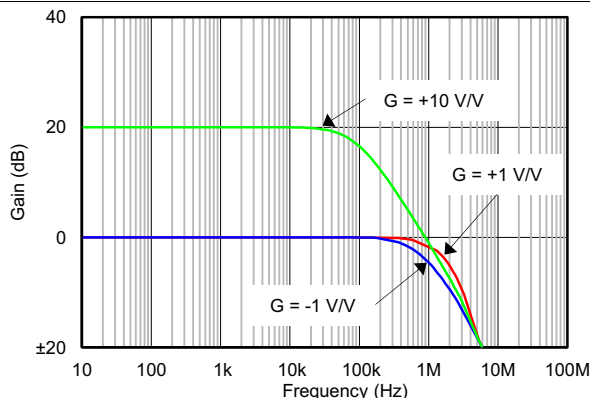

Figure 19. Closed-Loop Gain vs Frequency (Maximum Supply)

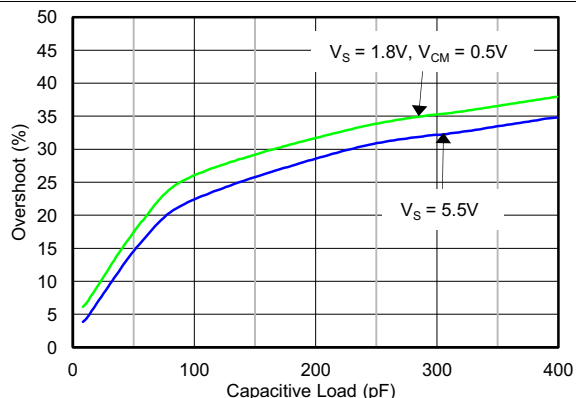

Figure 20. Small-Signal Overshoot vs Load Capacitance

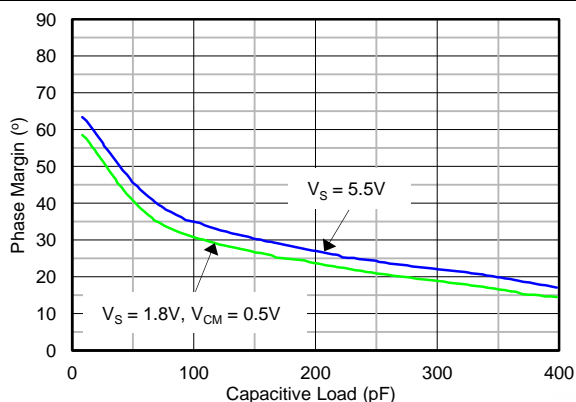

Figure 21. Phase Margin vs Capacitive Load

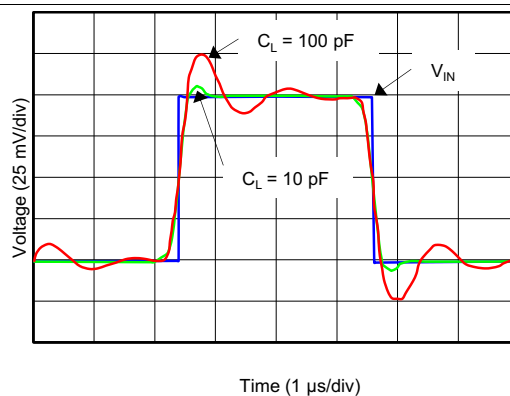

Figure 22. Small-Signal Pulse Response (Minimum Supply)

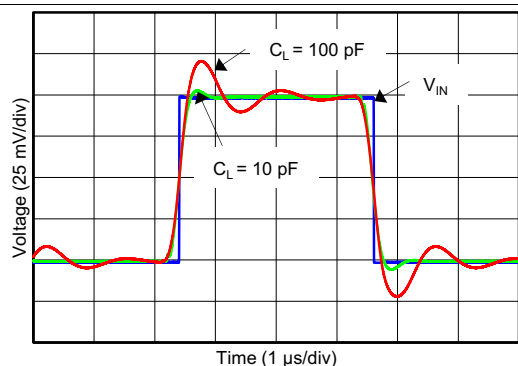

Figure 23. Small-Signal Pulse Response (Maximum Supply)

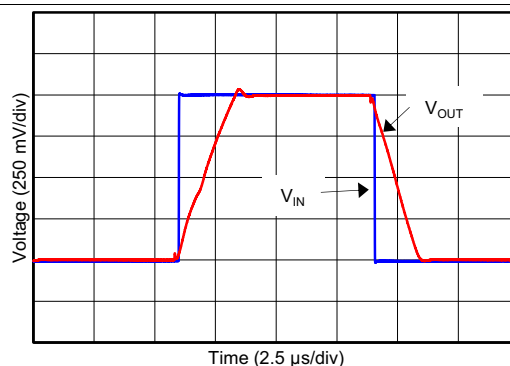
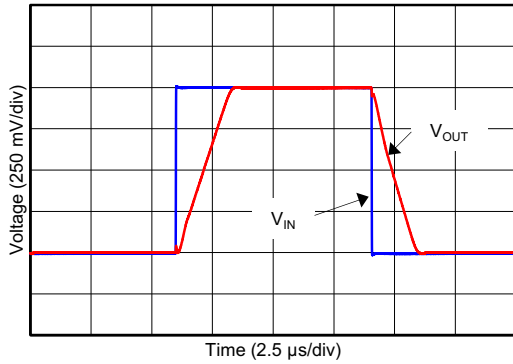

Figure 24. Large-Signal Pulse Response (Minimum Supply)

**Typical Characteristics (continued)**

At  $T_A = 25^\circ\text{C}$ ,  $V_S = 5\text{ V}$ ,  $R_L = 10\text{ k}\Omega$  connected to  $V_S / 2$ , and  $V_{CM} = V_{OUT} = V_S / 2$ , unless otherwise noted.



**Figure 25. Large-Signal Pulse Response (Maximum Supply)**

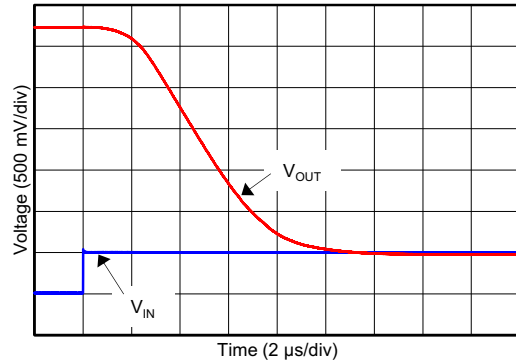

**Figure 26. Positive Overload Recovery**

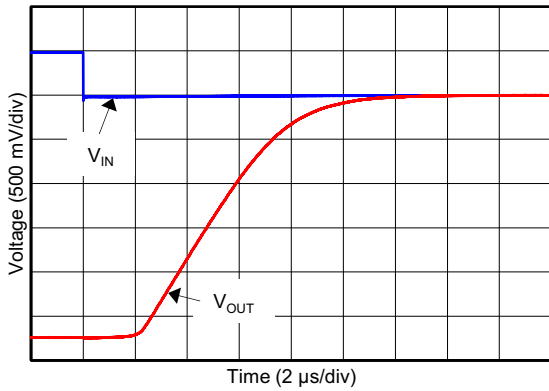

**Figure 27. Negative Overload Recovery**

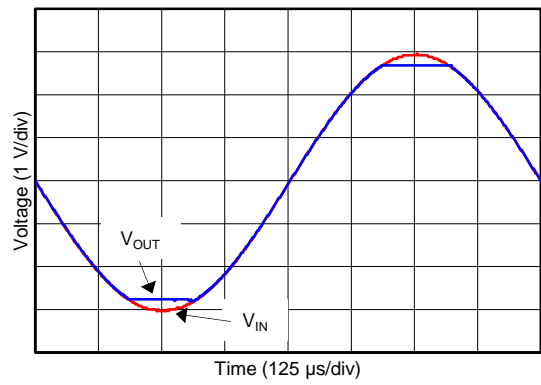

**Figure 28. No Phase Reversal**

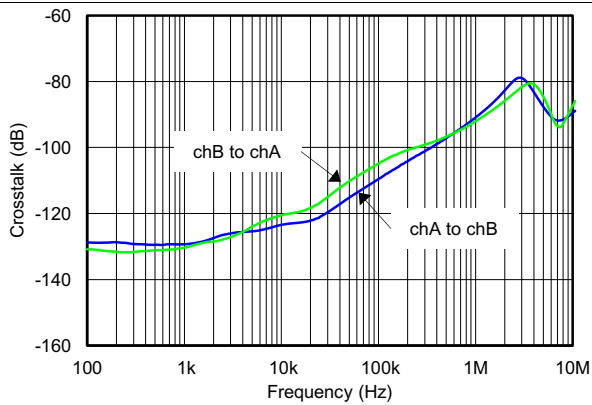

**Figure 29. Channel Separation vs Frequency**

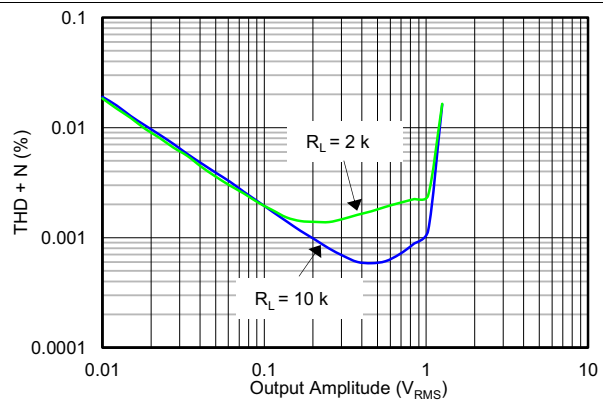

**Figure 30. THD+N vs Output Amplitude (Minimum Supply)**

Typical Characteristics (continued)

At  $T_A = 25^\circ\text{C}$ ,  $V_S = 5\text{ V}$ ,  $R_L = 10\text{ k}\Omega$  connected to  $V_S / 2$ , and  $V_{CM} = V_{OUT} = V_S / 2$ , unless otherwise noted.

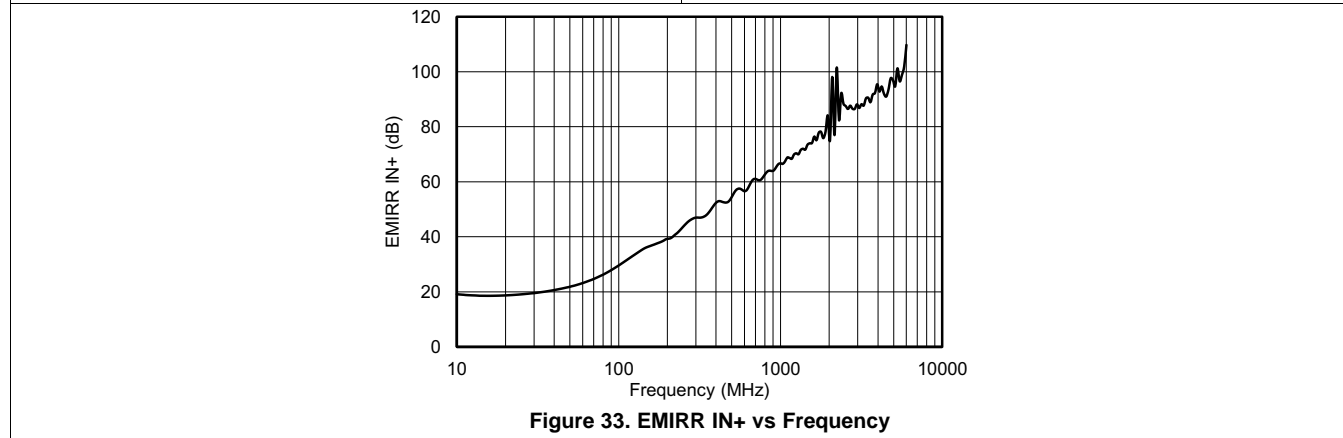
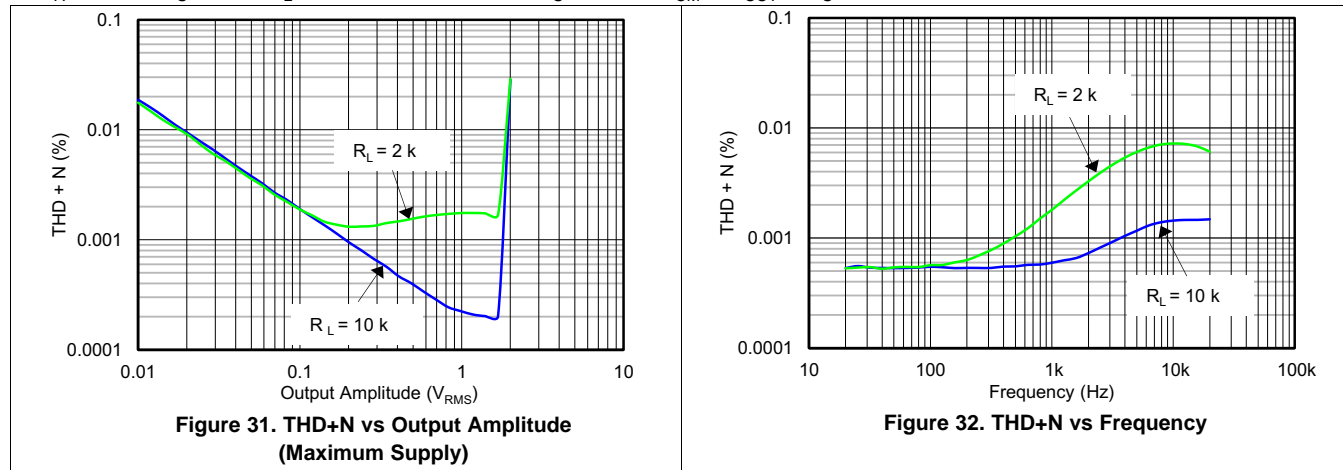

## 7 Detailed Description

### 7.1 Overview

The OPA2313-Q1 is a low-power, rail-to-rail input and output operational amplifier designed for cost-constrained applications. This device operates from 1.8 V to 5.5 V, is unity-gain stable, and suitable for a wide range of general-purpose applications. The class AB output stage is capable of driving loads greater than 10-k $\Omega$  connected to any point between V+ and ground. The input common-mode voltage range includes both rails, and allows the OPA2313-Q1 to be used in virtually any single-supply application. Rail-to-rail input and output swing significantly increases dynamic range, especially in low-supply applications, and makes this device ideal for driving sampling analog-to-digital converters (ADCs).

The OPA2313-Q1 features 1-MHz bandwidth and 0.5-V/ $\mu$ s slew rate with only 50- $\mu$ A supply current per channel, providing good ac performance at very low power consumption. Low frequency (dc) applications are also well served with a low input noise voltage of 25 nV/ $\sqrt{\text{Hz}}$  at 1 kHz, low input bias current (0.2 pA), and an input offset voltage of 0.5 mV (typical). The typical offset voltage drift is 2  $\mu$ V/ $^{\circ}\text{C}$ ; over the full temperature range the input offset voltage changes only 200  $\mu$ V (0.5 mV to 0.7 mV).

### 7.2 Functional Block Diagram

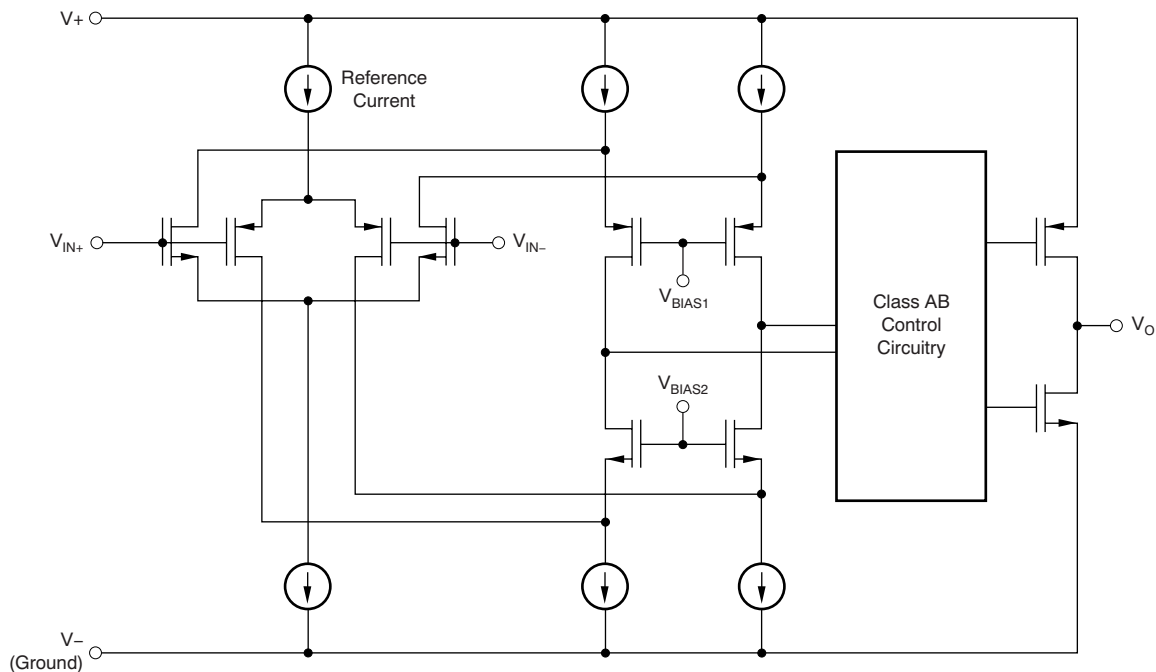



## 7.3 Feature Description

### 7.3.1 Operating Voltage

The OPA2313-Q1 device is fully specified and tested from 1.8 V to 5.5 V ( $\pm 0.9$  V to  $\pm 2.75$  V). Parameters that vary with supply voltage are illustrated in the [Typical Characteristics](#) section.

### 7.3.2 Rail-to-Rail Input

The input common-mode voltage range of the OPA2313-Q1 device extends 200 mV beyond the supply rails. This performance is achieved with a complementary input stage: an N-channel input differential pair in parallel with a P-channel differential pair, as shown in the [Functional Block Diagram](#) section. The N-channel pair is active for input voltages close to the positive rail, typically  $(V+) - 1.3$  V to 200 mV above the positive supply, while the P-channel pair is on for inputs from 200 mV below the negative supply to approximately  $(V+) - 1.3$  V. There is a small transition region, typically  $(V+) - 1.4$  V to  $(V+) - 1.2$  V, in which both pairs are on. This 200-mV transition region may vary up to 300 mV with process variation. Thus, the transition region (both stages on) may range from  $(V+) - 1.7$  V to  $(V+) - 1.5$  V on the low end, up to  $(V+) - 1.1$  V to  $(V+) - 0.9$  V on the high end. Within this transition region, PSRR, CMRR, offset voltage, offset drift, and THD may be degraded compared to device operation outside this region.

### 7.3.3 Rail-to-Rail Output

Designed as a micro-power, low-noise operational amplifier, the OPA2313-Q1 delivers a robust output drive capability. A class AB output stage with common-source transistors is used to achieve full rail-to-rail output swing capability. For resistive loads up to 10 k $\Omega$ , the output swings typically to within 5 mV of either supply rail regardless of the power-supply voltage applied. Different load conditions change the ability of the amplifier to swing close to the rails, as shown in [Figure 17](#).

### 7.3.4 Common-Mode Rejection Ratio (CMRR)

CMRR for the OPA2313-Q1 device is specified in several ways so the best match for a given application may be used; see the [Electrical Characteristics](#). First, the CMRR of the device in the common-mode range below the transition region ( $V_{CM} < (V+) - 1.3$  V) is given. This specification is the best indicator of the capability of the device when the application requires use of one of the differential input pairs. Second, the CMRR over the entire common-mode range is specified at ( $V_{CM} = -0.2$  V to 5.7 V). This last value includes the variations seen through the transition region, as shown in [Figure 7](#).

### 7.3.5 Capacitive Load and Stability

The OPA2313-Q1 device is designed to be used in applications where driving a capacitive load is required. As with all op amps, there may be specific instances where the OPA2313-Q1 device may become unstable. The particular op amp circuit configuration, layout, gain, and output loading are some of the factors to consider when establishing whether or not an amplifier is stable in operation. An op amp in the unity-gain ( $+1$ -V/V) buffer configuration that drives a capacitive load exhibits a greater tendency to be unstable than an amplifier operated at a higher noise gain. The capacitive load, in conjunction with the op amp output resistance, creates a pole within the feedback loop that degrades the phase margin. The degradation of the phase margin increases as the capacitive loading increases. When operating in the unity-gain configuration, the OPA2313-Q1 device remains stable with a pure capacitive load up to approximately 1 nF. The equivalent series resistance (ESR) of some capacitors ( $C_L$  greater than 1  $\mu$ F) is sufficient to alter the phase characteristics in the feedback loop such that the amplifier remains stable. Increasing the amplifier closed-loop gain allows the amplifier to drive increasingly larger capacitance. This increased capability is evident when observing the overshoot response of the amplifier at higher voltage gains. See the typical characteristic graph, [Figure 20](#).

## Feature Description (continued)

One technique for increasing the capacitive load drive capability of the amplifier when it operates in a unity-gain configuration is to insert a small resistor, typically  $10\ \Omega$  to  $20\ \Omega$ , in series with the output, as shown in Figure 34. This resistor significantly reduces the overshoot and ringing associated with large capacitive loads. One possible problem with this technique is that a voltage divider is created with the added series resistor and any resistor connected in parallel with the capacitive load. The voltage divider introduces a gain error at the output that reduces the output swing.

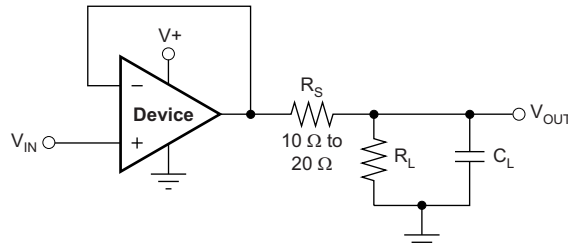

Figure 34. Improving Capacitive Load Drive

### 7.3.6 EMI Susceptibility and Input Filtering

Operational amplifiers vary with regard to the susceptibility of the device to electromagnetic interference (EMI). If conducted EMI enters the op amp, the DC offset observed at the amplifier output may shift from the nominal value while EMI is present. This shift is a result of signal rectification associated with the internal semiconductor junctions. While all op amp pin functions may be affected by EMI, the signal input pins are likely to be the most susceptible. The OPA2313-Q1 device incorporates an internal input low-pass filter that reduces the amplifiers response to EMI. Both common-mode and differential mode filtering are provided by this filter. The filter is designed for a common-mode cutoff frequency of approximately 35 MHz ( $-3\ \text{dB}$ ), with a rolloff of 20 dB per decade.

Texas Instruments has developed the ability to accurately measure and quantify the immunity of an operational amplifier over a broad frequency spectrum extending from 10 MHz to 6 GHz. The EMI rejection ratio (EMIRR) metric allows op amps to be directly compared by the EMI immunity. Figure 33 illustrates the results of this testing on the OPA2313-Q1 device. Detailed information may be found in *EMI Rejection Ratio of Operational Amplifiers*, available for download from [www.ti.com](http://www.ti.com).

### 7.3.7 Input and ESD Protection

The OPA2313-Q1 device incorporates internal electrostatic discharge (ESD) protection circuits on all pins. In the case of input and output pins, this protection primarily consists of current-steering diodes connected between the input and power-supply pins. The ESD protection diodes also provide in-circuit, input overdrive protection, as long as the current is limited to 10 mA as stated in the *Absolute Maximum Ratings*. Figure 35 shows how a series input resistor may be added to the driven input to limit the input current. The added resistor contributes thermal noise at the amplifier input and the value must be kept to a minimum in noise-sensitive applications.

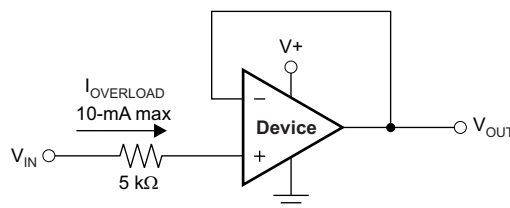

Figure 35. Input Current Protection

## 7.4 Device Functional Modes

The OPA2313-Q1 device has a single functional mode. The device is powered on as long as the power-supply voltage is between 1.8 V ( $\pm 0.9\ \text{V}$ ) and 5.5 V ( $\pm 2.75\ \text{V}$ ).

## 8 Application and Implementation

### NOTE

Information in the following applications sections is not part of the TI component specification, and TI does not warrant its accuracy or completeness. TI's customers are responsible for determining suitability of components for their purposes. Customers should validate and test their design implementation to confirm system functionality.

### 8.1 Application Information

The OPA2313-Q1 device is a low-power, rail-to-rail input and output operational amplifier. The device operates from 1.8 V to 5.5 V, is unity-gain stable, and is designed for a wide range of general-purpose applications. The class AB output stage is capable of driving loads greater than 10 kΩ connected to any point between V+ and ground. The input common-mode voltage range includes both rails, and allows the OPA2313-Q1 to be used in virtually any single-supply application.

### 8.2 Typical Application

A typical application for an operational amplifier is an inverting amplifier, as shown in [Figure 36](#). An inverting amplifier takes a positive voltage on the input and outputs a signal inverted to the input, making a negative voltage of the same magnitude. In the same manner, the amplifier also makes negative input voltages positive on the output. In addition, amplification may be added by selecting the input resistor ( $R_I$ ) and the feedback resistor ( $R_F$ ).

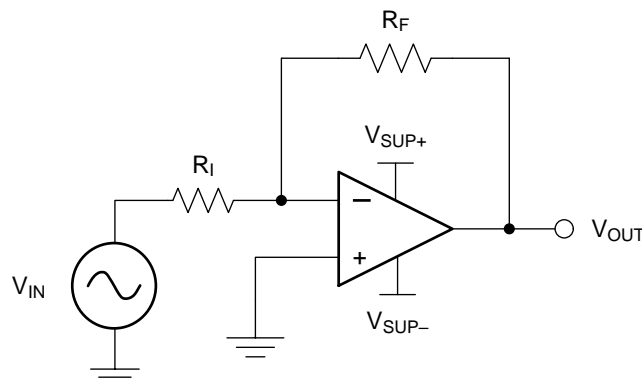

**Figure 36. Inverting Amplifier Application**

#### 8.2.1 Design Requirements

The supply voltage must be chosen to be larger than the input voltage range and the desired output range. The limits of the input common-mode range ( $V_{CM}$ ) and the output voltage swing to the rails ( $V_O$ ) must also be considered. For instance, this application scales a signal of  $\pm 0.5$  V (1 V) to  $\pm 1.8$  V (3.6 V). Setting the supply at  $\pm 2.5$  V is sufficient to accommodate this application.

#### 8.2.2 Detailed Design Procedure

Determine the gain required by the inverting amplifier using [Equation 1](#) and [Equation 2](#):

$$A_V = \frac{V_{OUT}}{V_{IN}} \tag{1}$$

$$A_V = \frac{1.8}{-0.5} = -3.6 \tag{2}$$

### Typical Application (continued)

When the desired gain is determined, choose a value for  $R_1$  or  $R_F$ . Choosing a value in the kilohm range is desirable for general-purpose applications because the amplifier circuit uses currents in the milliamp range. This milliamp current range ensures the device does not draw too much current. The trade-off is that very large resistors (100s of kilohms) draw the smallest current but generate the highest noise. Small resistors (100s of ohms) generate low noise but draw high current. This example uses 10 k $\Omega$  for  $R_1$ , resulting in a 36-k $\Omega$  resistor being used for  $R_F$ . The values are determined by Equation 3:

$$A_V = -\frac{R_F}{R_1} \tag{3}$$

### 8.2.3 Application Curve

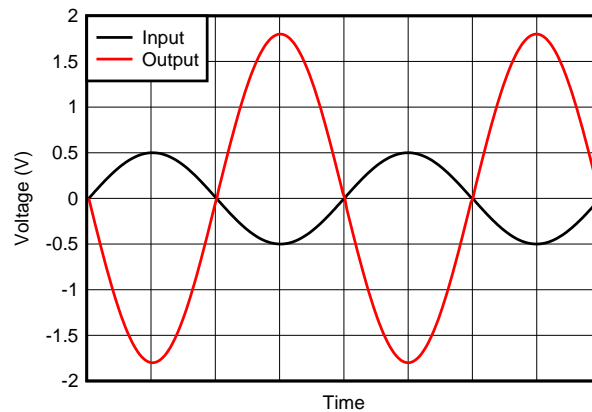
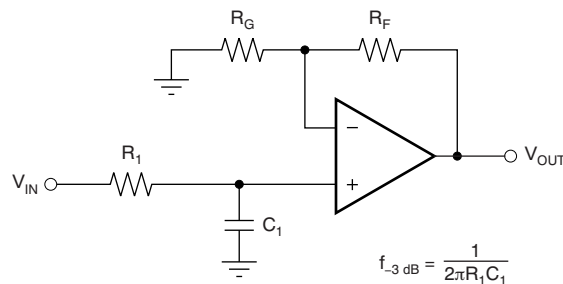

Figure 37. Inverting Amplifier Input and Output

### 8.3 System Examples

When receiving low-level signals, limiting the bandwidth of the incoming signals into the system is often required. The simplest way to establish this limited bandwidth is to place an RC filter at the noninverting terminal of the amplifier, as shown in Figure 38.



$$\frac{V_{OUT}}{V_{IN}} = \left(1 + \frac{R_F}{R_G}\right) \left(\frac{1}{1 + sR_1C_1}\right)$$

Figure 38. Single-Pole Low-Pass Filter

## System Examples (continued)

If even more attenuation is needed, a multiple pole filter is required. The Sallen-Key filter may be used for this task, as shown in Figure 39. For best results, the amplifier must have a bandwidth that is 8 to 10 times the filter frequency bandwidth. Failure to follow this guideline may result in phase shift of the amplifier.

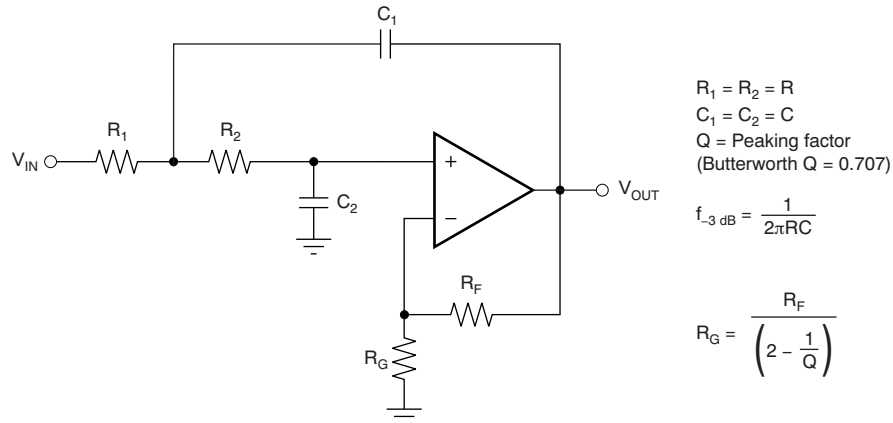

Figure 39. Two-Pole, Low-Pass, Sallen-Key Filter

## 9 Power Supply Recommendations

The OPA2313-Q1 device is specified for operation from 1.8 V to 5.5 V ( $\pm 0.9$  V to  $\pm 2.75$  V); many specifications apply from  $-40^\circ\text{C}$  to  $+125^\circ\text{C}$ . The *Typical Characteristics* section presents parameters that may exhibit significant variance with regard to operating voltage or temperature.

### CAUTION

Supply voltages larger than 7 V can permanently damage the device (see the *Absolute Maximum Ratings* table).

Place 0.1- $\mu\text{F}$  bypass capacitors close to the power-supply pins to reduce errors coupling in from noisy or high-impedance power supplies. For more detailed information on bypass capacitor placement, refer to the *Layout Guidelines* section.

## 10 Layout

### 10.1 Layout Guidelines

For best operational performance of the device, use good printed circuit board (PCB) layout practices, including:

- Noise may propagate into analog circuitry through the power pins of the circuit and the operational amplifier. Use bypass capacitors to reduce the coupled noise by providing low-impedance power sources local to the analog circuitry.
  - Connect low-ESR, 0.1- $\mu$ F ceramic bypass capacitors between each supply pin and ground, placed as close to the device as possible. A single bypass capacitor from V+ to ground is applicable for single-supply applications.
- Separate grounding for analog and digital portions of the circuitry is one of the simplest and most effective methods of noise suppression. One or more layers on multilayer PCBs are usually devoted to ground planes. A ground plane helps distribute heat and reduces EMI noise pickup. Take care to physically separate digital and analog grounds, paying attention to the flow of the ground current. For more detailed information, see [Circuit Board Layout Techniques](#).
- To reduce parasitic coupling, run the input traces as far away from the supply or output traces as possible. If the traces cannot be kept separate, crossing the sensitive trace perpendicularly is much better than crossing in parallel with the noisy trace.
- Place the external components as close to the device as possible. Keep  $R_F$  and  $R_G$  close to the inverting input to minimize parasitic capacitance, as shown in [Figure 40](#).
- Keep the length of input traces as short as possible. Remember that the input traces are the most sensitive part of the circuit.
- Consider a driven, low-impedance guard ring around the critical traces. A guard ring may significantly reduce leakage currents from nearby traces that are at different potentials.

### 10.2 Layout Example

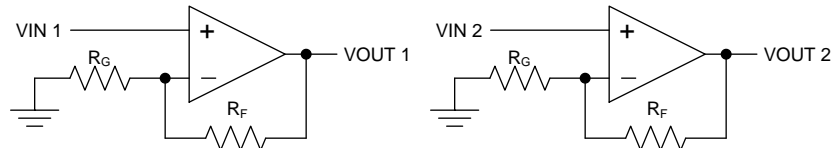

Figure 40. Schematic Representation for [Figure 41](#)

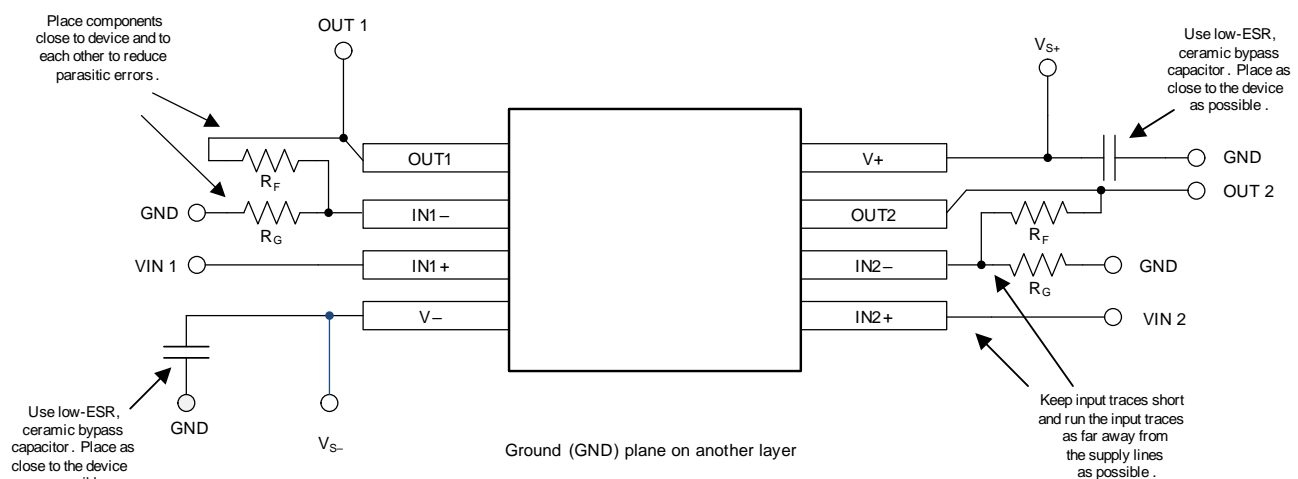

Figure 41. Layout Example

## 11 Device and Documentation Support

### 11.1 Documentation Support

#### 11.1.1 Related Documentation

For related documentation, see the following:

- [EMI Rejection Ratio of Operational Amplifiers](#)
- [Circuit Board Layout Techniques](#)

### 11.2 Receiving Notification of Documentation Updates

To receive notification of documentation updates, navigate to the device product folder on ti.com. In the upper right corner, click on *Alert me* to register and receive a weekly digest of any product information that has changed. For change details, review the revision history included in any revised document.

### 11.3 Community Resources

The following links connect to TI community resources. Linked contents are provided "AS IS" by the respective contributors. They do not constitute TI specifications and do not necessarily reflect TI's views; see TI's [Terms of Use](#).

**TI E2E™ Online Community** *TI's Engineer-to-Engineer (E2E) Community*. Created to foster collaboration among engineers. At e2e.ti.com, you can ask questions, share knowledge, explore ideas and help solve problems with fellow engineers.

**Design Support** *TI's Design Support* Quickly find helpful E2E forums along with design support tools and contact information for technical support.

### 11.4 Trademarks

E2E is a trademark of Texas Instruments.

### 11.5 Electrostatic Discharge Caution



This integrated circuit can be damaged by ESD. Texas Instruments recommends that all integrated circuits be handled with appropriate precautions. Failure to observe proper handling and installation procedures can cause damage.

ESD damage can range from subtle performance degradation to complete device failure. Precision integrated circuits may be more susceptible to damage because very small parametric changes could cause the device not to meet its published specifications.

### 11.6 Glossary

[SLYZ022](#) — *TI Glossary*.

This glossary lists and explains terms, acronyms, and definitions.

## 12 Mechanical, Packaging, and Orderable Information

The following pages include mechanical, packaging, and orderable information. This information is the most current data available for the designated devices. This data is subject to change without notice and revision of this document. For browser-based versions of this data sheet, refer to the left-hand navigation.

**PACKAGING INFORMATION**

Orderable Device	Status (1)	Package Type	Package Drawing	Pins	Package Qty	Eco Plan (2)	Lead/Ball Finish (6)	MSL Peak Temp (3)	Op Temp (°C)	Device Marking (4/5)	Samples
OPA2313QDGKRQ1	ACTIVE	VSSOP	DGK	8	2500	Green (RoHS & no Sb/Br)	NIPDAUAG	Level-2-260C-1 YEAR	-40 to 125	23131	<a href="#">Samples</a>
OPA2313QDRQ1	ACTIVE	SOIC	D	8	2500	Green (RoHS & no Sb/Br)	NIPDAU	Level-2-260C-1 YEAR	-40 to 125	O2313Q	<a href="#">Samples</a>

(1) The marketing status values are defined as follows:

**ACTIVE:** Product device recommended for new designs.

**LIFEBUY:** TI has announced that the device will be discontinued, and a lifetime-buy period is in effect.

**NRND:** Not recommended for new designs. Device is in production to support existing customers, but TI does not recommend using this part in a new design.

**PREVIEW:** Device has been announced but is not in production. Samples may or may not be available.

**OBSOLETE:** TI has discontinued the production of the device.

(2) **RoHS:** TI defines "RoHS" to mean semiconductor products that are compliant with the current EU RoHS requirements for all 10 RoHS substances, including the requirement that RoHS substance do not exceed 0.1% by weight in homogeneous materials. Where designed to be soldered at high temperatures, "RoHS" products are suitable for use in specified lead-free processes. TI may reference these types of products as "Pb-Free".

**RoHS Exempt:** TI defines "RoHS Exempt" to mean products that contain lead but are compliant with EU RoHS pursuant to a specific EU RoHS exemption.

**Green:** TI defines "Green" to mean the content of Chlorine (Cl) and Bromine (Br) based flame retardants meet JS709B low halogen requirements of <=1000ppm threshold. Antimony trioxide based flame retardants must also meet the <=1000ppm threshold requirement.

(3) MSL, Peak Temp. - The Moisture Sensitivity Level rating according to the JEDEC industry standard classifications, and peak solder temperature.

(4) There may be additional marking, which relates to the logo, the lot trace code information, or the environmental category on the device.

(5) Multiple Device Markings will be inside parentheses. Only one Device Marking contained in parentheses and separated by a "~" will appear on a device. If a line is indented then it is a continuation of the previous line and the two combined represent the entire Device Marking for that device.

(6) Lead/Ball Finish - Orderable Devices may have multiple material finish options. Finish options are separated by a vertical ruled line. Lead/Ball Finish values may wrap to two lines if the finish value exceeds the maximum column width.

**Important Information and Disclaimer:**The information provided on this page represents TI's knowledge and belief as of the date that it is provided. TI bases its knowledge and belief on information provided by third parties, and makes no representation or warranty as to the accuracy of such information. Efforts are underway to better integrate information from third parties. TI has taken and continues to take reasonable steps to provide representative and accurate information but may not have conducted destructive testing or chemical analysis on incoming materials and chemicals. TI and TI suppliers consider certain information to be proprietary, and thus CAS numbers and other limited information may not be available for release.

In no event shall TI's liability arising out of such information exceed the total purchase price of the TI part(s) at issue in this document sold by TI to Customer on an annual basis.



**OTHER QUALIFIED VERSIONS OF OPA2313-Q1 :**

- Catalog: [OPA2313](#)

## NOTE: Qualified Version Definitions:

- Catalog - TI's standard catalog product

## TAPE AND REEL INFORMATION



### QUADRANT ASSIGNMENTS FOR PIN 1 ORIENTATION IN TAPE



\*All dimensions are nominal

Device	Package Type	Package Drawing	Pins	SPQ	Reel Diameter (mm)	Reel Width W1 (mm)	A0 (mm)	B0 (mm)	K0 (mm)	P1 (mm)	W (mm)	Pin1 Quadrant
OPA2313QDGKRQ1	VSSOP	DGK	8	2500	330.0	12.4	5.3	3.4	1.4	8.0	12.0	Q1
OPA2313QDRQ1	SOIC	D	8	2500	330.0	12.4	6.4	5.2	2.1	8.0	12.0	Q1

**TAPE AND REEL BOX DIMENSIONS**

\*All dimensions are nominal

Device	Package Type	Package Drawing	Pins	SPQ	Length (mm)	Width (mm)	Height (mm)
OPA2313QDGKRQ1	VSSOP	DGK	8	2500	366.0	364.0	50.0
OPA2313QDRQ1	SOIC	D	8	2500	340.5	338.1	20.6



D0008A

# PACKAGE OUTLINE

SOIC - 1.75 mm max height

SMALL OUTLINE INTEGRATED CIRCUIT



4214825/C 02/2019

NOTES:

- Linear dimensions are in inches [millimeters]. Dimensions in parenthesis are for reference only. Controlling dimensions are in inches. Dimensioning and tolerancing per ASME Y14.5M.
- This drawing is subject to change without notice.
- This dimension does not include mold flash, protrusions, or gate burrs. Mold flash, protrusions, or gate burrs shall not exceed .006 [0.15] per side.
- This dimension does not include interlead flash.
- Reference JEDEC registration MS-012, variation AA.

# EXAMPLE BOARD LAYOUT

D0008A

SOIC - 1.75 mm max height

SMALL OUTLINE INTEGRATED CIRCUIT



LAND PATTERN EXAMPLE  
EXPOSED METAL SHOWN  
SCALE:8X



SOLDER MASK DETAILS

4214825/C 02/2019

NOTES: (continued)

6. Publication IPC-7351 may have alternate designs.

7. Solder mask tolerances between and around signal pads can vary based on board fabrication site.

# EXAMPLE STENCIL DESIGN

D0008A

SOIC - 1.75 mm max height

SMALL OUTLINE INTEGRATED CIRCUIT



SOLDER PASTE EXAMPLE  
BASED ON .005 INCH [0.125 MM] THICK STENCIL  
SCALE:8X

4214825/C 02/2019

NOTES: (continued)

8. Laser cutting apertures with trapezoidal walls and rounded corners may offer better paste release. IPC-7525 may have alternate design recommendations.
9. Board assembly site may have different recommendations for stencil design.

DGK (S-PDSO-G8)

PLASTIC SMALL-OUTLINE PACKAGE



- NOTES:
- A. All linear dimensions are in millimeters.
  - B. This drawing is subject to change without notice.
  - C. Body length does not include mold flash, protrusions, or gate burrs. Mold flash, protrusions, or gate burrs shall not exceed 0.15 per end.
  - D. Body width does not include interlead flash. Interlead flash shall not exceed 0.50 per side.
  - E. Falls within JEDEC MO-187 variation AA, except interlead flash.



- NOTES:
- A. All linear dimensions are in millimeters.
  - B. This drawing is subject to change without notice.
  - C. Publication IPC-7351 is recommended for alternate designs.
  - D. Laser cutting apertures with trapezoidal walls and also rounding corners will offer better paste release. Customers should contact their board assembly site for stencil design recommendations. Refer to IPC-7525 for other stencil recommendations.
  - E. Customers should contact their board fabrication site for solder mask tolerances between and around signal pads.



## IMPORTANT NOTICE AND DISCLAIMER

TI PROVIDES TECHNICAL AND RELIABILITY DATA (INCLUDING DATASHEETS), DESIGN RESOURCES (INCLUDING REFERENCE DESIGNS), APPLICATION OR OTHER DESIGN ADVICE, WEB TOOLS, SAFETY INFORMATION, AND OTHER RESOURCES "AS IS" AND WITH ALL FAULTS, AND DISCLAIMS ALL WARRANTIES, EXPRESS AND IMPLIED, INCLUDING WITHOUT LIMITATION ANY IMPLIED WARRANTIES OF MERCHANTABILITY, FITNESS FOR A PARTICULAR PURPOSE OR NON-INFRINGEMENT OF THIRD PARTY INTELLECTUAL PROPERTY RIGHTS.

These resources are intended for skilled developers designing with TI products. You are solely responsible for (1) selecting the appropriate TI products for your application, (2) designing, validating and testing your application, and (3) ensuring your application meets applicable standards, and any other safety, security, or other requirements. These resources are subject to change without notice. TI grants you permission to use these resources only for development of an application that uses the TI products described in the resource. Other reproduction and display of these resources is prohibited. No license is granted to any other TI intellectual property right or to any third party intellectual property right. TI disclaims responsibility for, and you will fully indemnify TI and its representatives against, any claims, damages, costs, losses, and liabilities arising out of your use of these resources.

TI's products are provided subject to TI's Terms of Sale ([www.ti.com/legal/termsofsale.html](http://www.ti.com/legal/termsofsale.html)) or other applicable terms available either on [ti.com](http://ti.com) or provided in conjunction with such TI products. TI's provision of these resources does not expand or otherwise alter TI's applicable warranties or warranty disclaimers for TI products.

Mailing Address: Texas Instruments, Post Office Box 655303, Dallas, Texas 75265  
Copyright © 2020, Texas Instruments Incorporated