

Q1PACK Module

NXH50M65L4Q1SG, NXH50M65L4Q1PTG

This high-density, integrated power module combines high-performance IGBTs with rugged anti-parallel diodes.

Features

- Extremely Efficient Trench with Fieldstop Technology
- Low Switching Loss Reduces System Power Dissipation
- Module Design Offers High Power Density
- Low Inductive Layout
- Q1PACK Packages with Solder and Pressfit Pins

Typical Applications

- Solar Inverters
- Uninterruptable Power Supplies

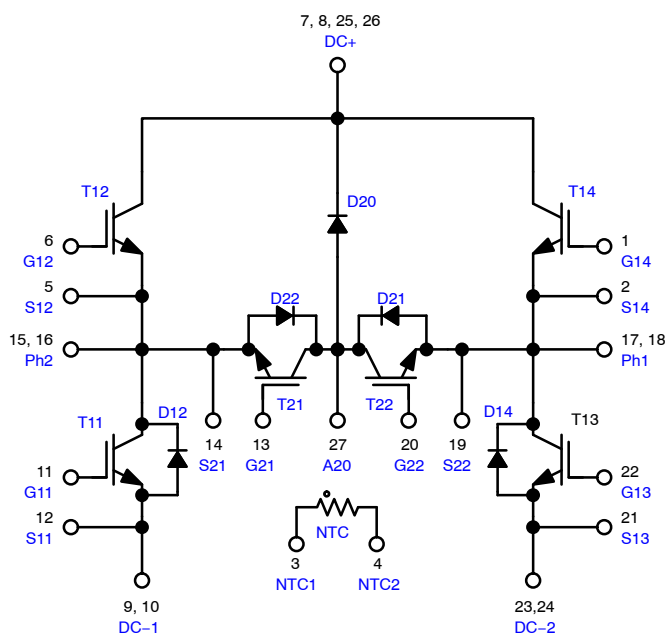

Figure 1. Schematic

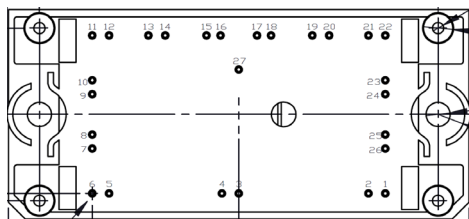
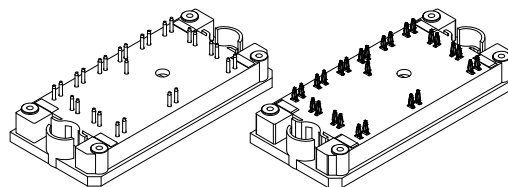

Figure 2. Pin Assignments

50 A, 650 V Module



PIM27, 71x37.4
(SOLDER PIN)
CASE 180CA

PIM27, 71x37.4
(PRESSFIT PIN)
CASE 180CP

MARKING DIAGRAM

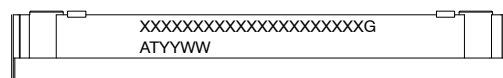

XXXXXX = Specific Device Code
G = Pb-Free Package
AT = Assembly & Test Site Code
YYWW = Year and Work Week Code

ORDERING INFORMATION

See detailed ordering and shipping information on page 9 of this data sheet.

NXH50M65L4Q1SG, NXH50M65L4Q1PTG

ABSOLUTE MAXIMUM RATINGS

| Rating | Symbol | Value | Unit |
|---|------------------|----------|------------------|
| IGBT (T11, T12, T13, T14, T21, T22) | | | |
| Collector-emitter voltage | V_{CES} | 650 | V |
| Collector current @ $T_h = 80^\circ\text{C}$ (per IGBT) | I_C | 48 | A |
| Pulsed collector current, T_{pulse} limited by $T_{j\text{max}}$ | I_{CM} | 144 | A |
| Power Dissipation Per IGBT $T_j = T_{j\text{max}}, T_h = 80^\circ\text{C}$ | P_{tot} | 72 | W |
| Gate-emitter voltage | V_{GE} | ± 20 | V |
| Maximum Junction Temperature | T_J | 175 | $^\circ\text{C}$ |

DIODE (D12, D14, D20, D21, D22)

| | | | |
|--|------------------|-----|------------------|
| Peak Repetitive Reverse Voltage | V_{RRM} | 650 | V |
| Forward Current, DC @ $T_h = 80^\circ\text{C}$ (per Diode) | I_F | 50 | A |
| Nonrepetitive Peak Surge Current (Surge applied at rated load conditions halfwave, single phase, 60 Hz) | I_{FSM} | 225 | A |
| Power Dissipation Per Diode $T_j = T_{j\text{max}}, T_h = 80^\circ\text{C}$ | P_{tot} | 86 | W |
| Maximum Junction Temperature | T_J | 175 | $^\circ\text{C}$ |

THERMAL PROPERTIES

| | | | |
|---|-------------------|-----------------------------------|------------------|
| Operating Temperature under switching condition | $T_{VJ\text{OP}}$ | -40 to ($T_{j\text{max}} - 25$) | $^\circ\text{C}$ |
| Storage Temperature range | T_{stg} | -40 to 125 | $^\circ\text{C}$ |

INSULATION PROPERTIES

| | | | |
|--|-----------------|------|-----|
| Isolation test voltage, $t = 2$ min, 60 Hz | V_{is} | 4000 | Vac |
| Creepage distance | | 12.7 | mm |

Stresses exceeding those listed in the Maximum Ratings table may damage the device. If any of these limits are exceeded, device functionality should not be assumed, damage may occur and reliability may be affected.

ELECTRICAL CHARACTERISTICS ($T_J = 25^\circ\text{C}$ unless otherwise specified)

| Parameter | Test Condition | Symbol | Min | Typ | Max | Unit |
|--|---|----------------------|-----|--------------|-----------|---------------|
| IGBT (T11, T12, T13, T14, T21, T22) | | | | | | |
| Collector-emitter cutoff current | $V_{GE} = 0\text{ V}, V_{CE} = 650\text{ V}$ | I_{CES} | - | - | 300 | μA |
| Collector-emitter saturation voltage | $V_{GE} = 15\text{ V}, I_C = 50\text{ A}, T_j = 25^\circ\text{C}$ $V_{GE} = 15\text{ V}, I_C = 50\text{ A}, T_j = 150^\circ\text{C}$ | $V_{CE(\text{sat})}$ | - | 1.56 1.76 | 2.22 - | V |
| Gate-emitter threshold voltage | $V_{GE} = V_{CE}, I_C = 50\text{ mA}$ | $V_{GE(\text{TH})}$ | 3.1 | 4.45 | 5.2 | V |
| Gate leakage current | $V_{GE} = 20\text{ V}, V_{CE} = 0\text{ V}$ | I_{GES} | - | - | 400 | nA |
| Turn-on delay time | $T_j = 25^\circ\text{C}$ $V_{CE} = 350\text{ V}, I_C = 50\text{ A}$ $V_{GE} = 15\text{ V}, -9\text{ V}, R_G = 6\ \Omega$ | $t_{d(\text{on})}$ | - | 14 | - | ns |
| Rise time | | t_r | - | 20 | - | |
| Turn-off delay time | | $t_{d(\text{off})}$ | - | 68 | - | |
| Fall time | | t_f | - | 20 | - | |
| Turn on switching loss | | E_{on} | - | 0.46 | - | mJ |
| Turn off switching loss | | E_{off} | - | 0.44 | - | |
| Turn-on delay time | $T_j = 125^\circ\text{C}$ $V_{CE} = 350\text{ V}, I_C = 50\text{ A}$ $V_{GE} = 15\text{ V}, -9\text{ V}, R_G = 6\ \Omega$ | $t_{d(\text{on})}$ | - | 16 | - | ns |
| Rise time | | t_r | - | 23 | - | |
| Turn-off delay time | | $t_{d(\text{off})}$ | - | 78 | - | |
| Fall time | | t_f | - | 52 | - | |
| Turn on switching loss | | E_{on} | - | 0.78 | - | mJ |
| Turn off switching loss | | E_{off} | - | 0.60 | - | |

NXH50M65L4Q1SG, NXH50M65L4Q1PTG

ELECTRICAL CHARACTERISTICS (T_J = 25°C unless otherwise specified) (continued)

| Parameter | Test Condition | Symbol | Min | Typ | Max | Unit |
|--|---|-------------------|-----|------|-----|------|
| IGBT (T11, T12, T13, T14, T21, T22) | | | | | | |
| Input capacitance | V _{CE} = 20 V, V _{GE} = 0 V, f = 1 MHz | C _{ies} | – | 3137 | – | pF |
| Output capacitance | | C _{oes} | – | 146 | – | |
| Reverse transfer capacitance | | C _{res} | – | 17 | – | |
| Gate charge total | V _{CE} = 350 V, I _C = 40 A, V _{GE} = ±15 V | Q _g | – | 180 | – | nC |
| Thermal Resistance – chip–to–heatsink | Thermal grease, Thickness = 2.1 Mil ±2% λ = 2.9 W/mK | R _{thJH} | – | 1.32 | – | °C/W |
| Thermal Resistance – chip–to–case | | R _{thJC} | – | 0.96 | – | °C/W |

IGBT INVERSE DIODE (D12, D14, D21, D22)

| | | | | | | |
|---------------------------------------|--|----------------------|--------|-------------|----------|------|
| Forward voltage | I _F = 50 A, T _J = 25°C I _F = 50 A, T _J = 175°C | V _F | – – | 2.25 1.7 | 2.7 – | V |
| Reverse Recovery Time | T _J = 25°C V _{CE} = 350 V, I _C = 50 A V _{GE} = 15 V, –9 V, R _G = 6 Ω | t _{rr} | – | 28 | – | ns |
| Reverse Recovery Current | | Q _{rr} | – | 281 | – | nc |
| Peak Reverse Recovery Current | | I _{rrm} | – | 18 | – | A |
| Peak Rate of Fall of Recovery Current | | Di/dt _{max} | – | 1.42 | – | A/μs |
| Reverse Recovery Energy | | E _{rr} | – | 33 | – | μJ |
| Reverse Recovery Time | T _J = 125°C V _{CE} = 350 V, I _C = 50 A V _{GE} = 15 V, –9 V, R _G = 6 Ω | t _{rr} | – | 65 | – | ns |
| Reverse Recovery Current | | Q _{rr} | – | 1094 | – | nc |
| Peak Reverse Recovery Current | | I _{rrm} | – | 33 | – | A |
| Peak Rate of Fall of Recovery Current | | Di/dt _{max} | – | 1.32 | – | A/μs |
| Reverse Recovery Energy | | E _{rr} | – | 198 | – | μJ |
| Thermal Resistance – chip–to–heatsink | Thermal grease, Thickness = 2.1 Mil ±2% λ = 2.9 W/mK | R _{thJH} | – | 1.10 | – | °C/W |
| Thermal Resistance – chip–to–case | | R _{thJC} | – | 0.79 | – | °C/W |

DIODE (D20)

| | | | | | | |
|---------------------------------------|---|-------------------|--------|-------------|----------|------|
| Forward voltage | I _F = 50 A, T _J = 25°C I _F = 50 A, T _J = 175°C | V _F | – – | 2.25 1.7 | 2.7 – | V |
| Reverse leakage current | V _{CE} = 650 V, V _{GE} = 0 V | I _r | – | – | 300 | μA |
| Thermal Resistance – chip–to–heatsink | Thermal grease, Thickness = 2.1 Mil ±2% λ = 2.9 W/mK | R _{thJH} | – | 1.10 | – | °C/W |
| Thermal Resistance – chip–to–case | | R _{thJC} | – | 0.79 | – | °C/W |

THERMISTOR CHARACTERISTICS

| | | | | | | |
|----------------------------|---------------------|------------------|----|------|------|-------|
| Nominal resistance | T = 25°C | R ₂₅ | – | 22 | – | kΩ |
| Nominal resistance | T = 100°C | R ₁₀₀ | – | 1486 | – | Ω |
| Deviation of R25 | | R/R | –5 | – | 5 | % |
| Power dissipation | | P _D | – | 200 | – | mW |
| Power dissipation constant | | | – | 2 | – | mW/°C |
| B-value | B (25/50), tol ±3% | | – | – | 3950 | °C |
| B-value | B (25/100), tol ±3% | | – | – | 3998 | °C |
| NTC reference | | | – | – | B | |

Product parametric performance is indicated in the Electrical Characteristics for the listed test conditions, unless otherwise noted. Product performance may not be indicated by the Electrical Characteristics if operated under different conditions.

NXH50M65L4Q1SG, NXH50M65L4Q1PTG

TYPICAL CHARACTERISTICS – IGBT (T11, T12, T13, T14, T21, T22)

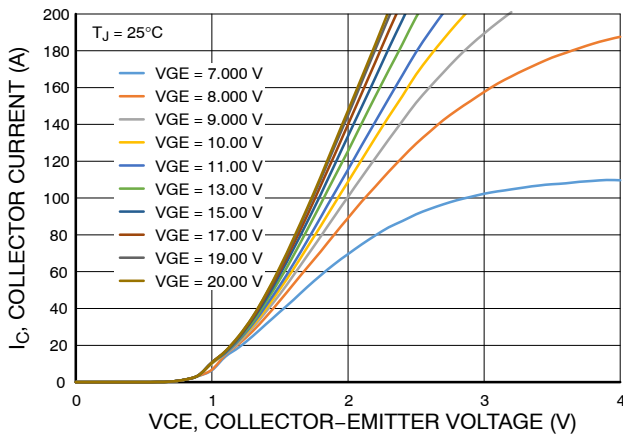

Figure 3. Typical Output Characteristics

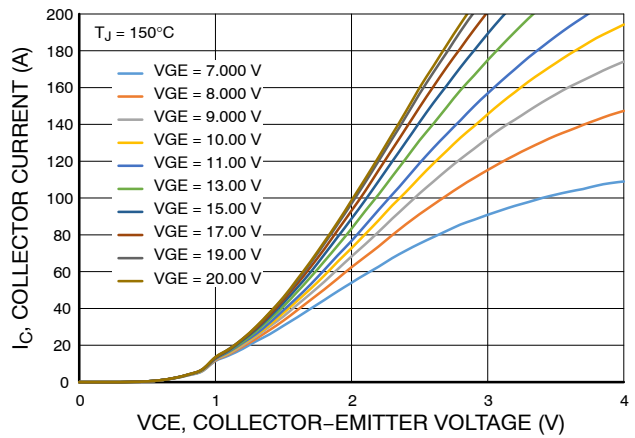

Figure 4. Typical Output Characteristics

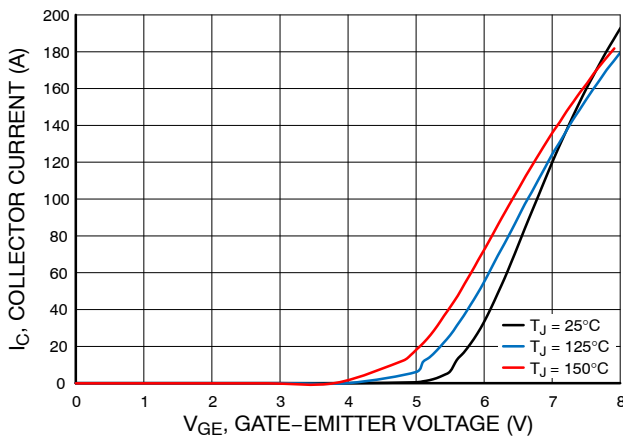

Figure 5. Typical Transfer Characteristics

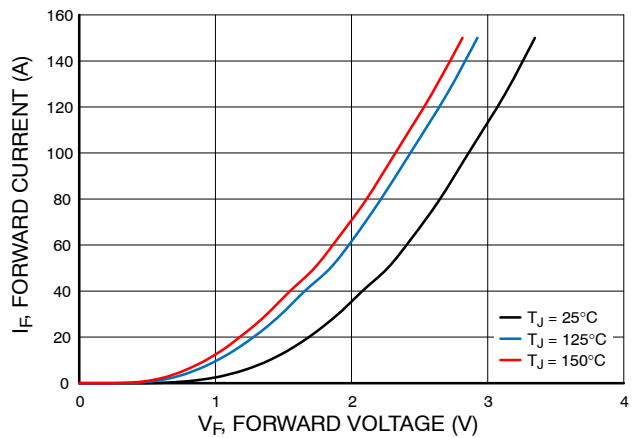

Figure 6. Diode Forward Characteristics

TYPICAL CHARACTERISTICS – (T11, T12, T13, T14) IGBT COMMUTATES D21, D22 DIODE

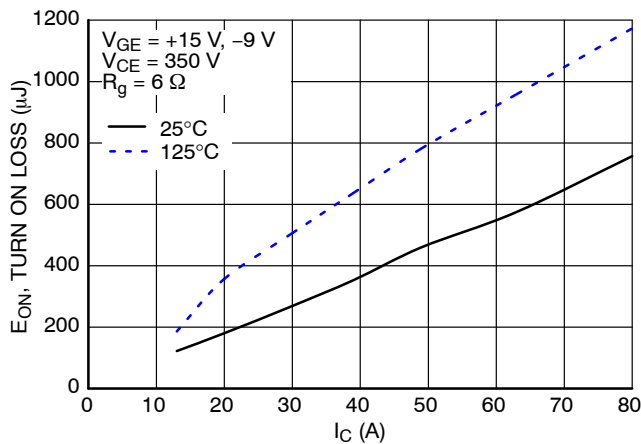

Figure 7. Typical Turn ON Loss vs. IC

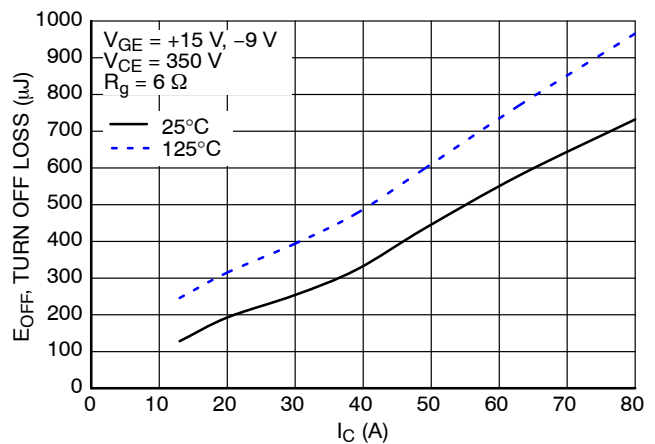

Figure 8. Typical Turn OFF Loss vs. IC

NXH50M65L4Q1SG, NXH50M65L4Q1PTG

TYPICAL CHARACTERISTICS – (T11, T12, T13, T14) IGBT COMMUTATES D21, D22 DIODE (CONTINUED)

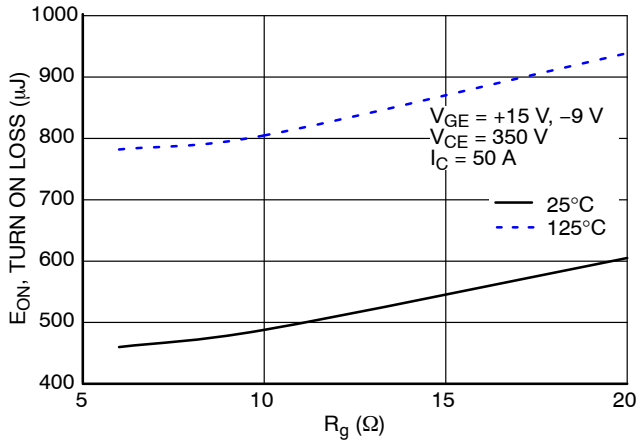

Figure 9. Typical Turn ON Loss vs. Rg

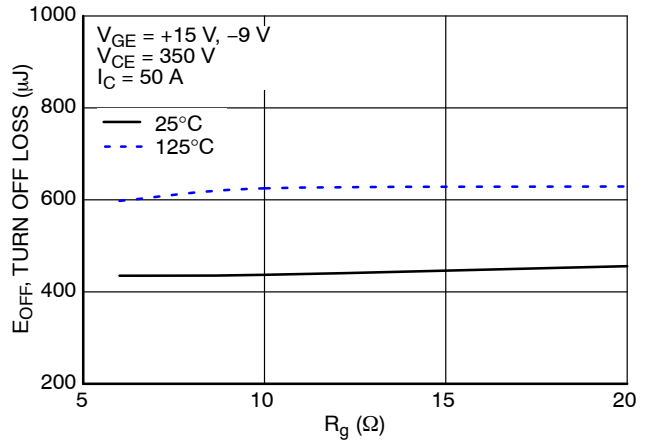

Figure 10. Typical Turn OFF Loss vs. Rg

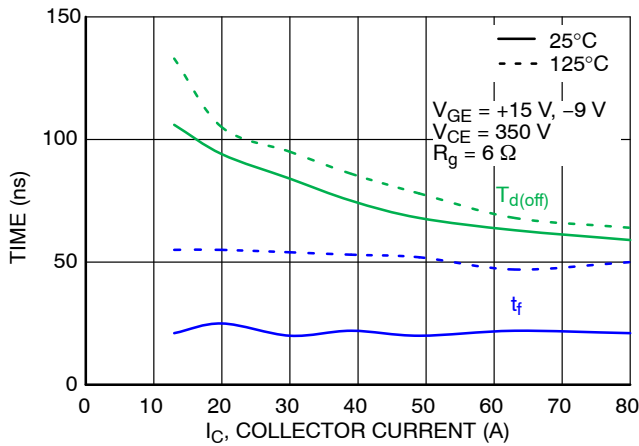

Figure 11. Typical Turn-Off Switching Time vs. IC

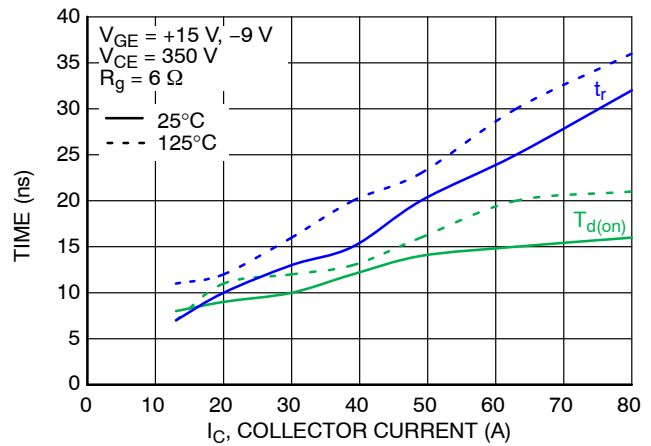

Figure 12. Typical Turn-On Switching Time vs. IC

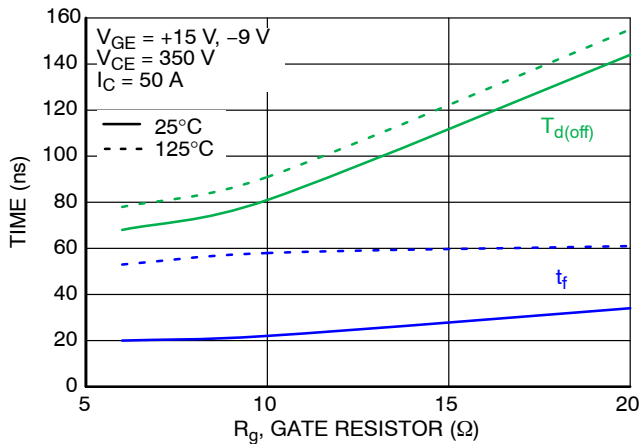

Figure 13. Typical Turn-Off Switching Time vs. Rg

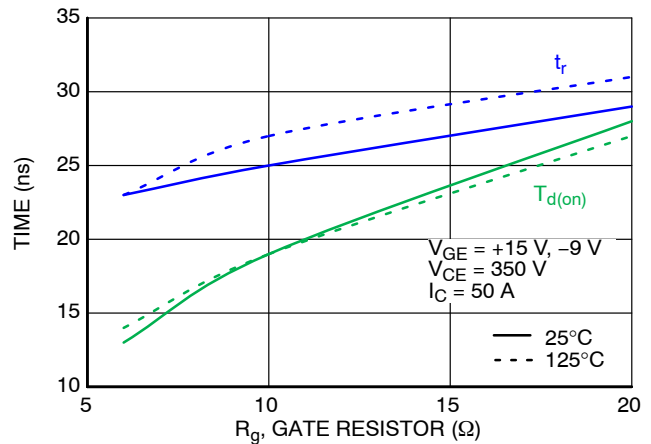

Figure 14. Typical Turn-On Switching Time vs. Rg

NXH50M65L4Q1SG, NXH50M65L4Q1PTG

TYPICAL CHARACTERISTICS – (T21, T22) IGBT COMMUTATES D20 DIODE

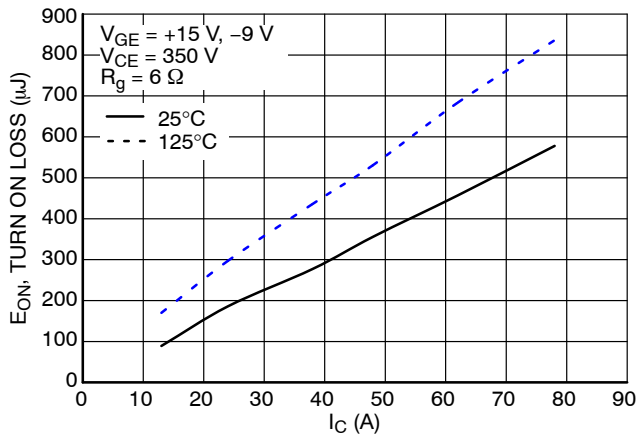

Figure 15. Typical Turn ON Loss vs. IC

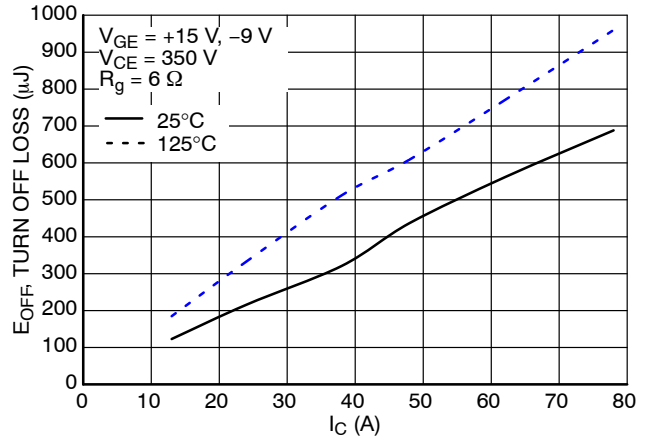

Figure 16. Typical Turn OFF Loss vs. IC

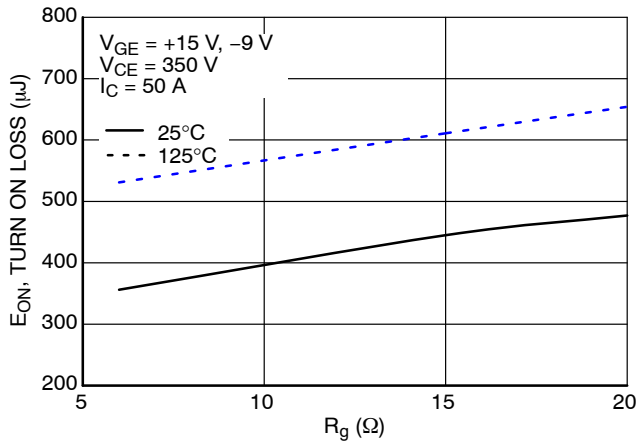

Figure 17. Typical Turn ON Loss vs. R_G

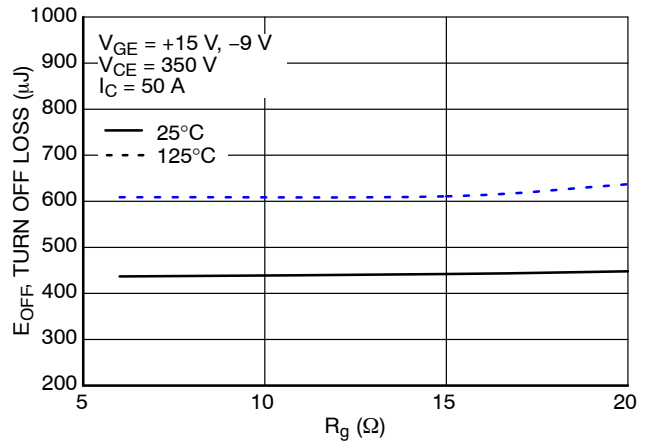

Figure 18. Typical Turn OFF Loss vs. R_G

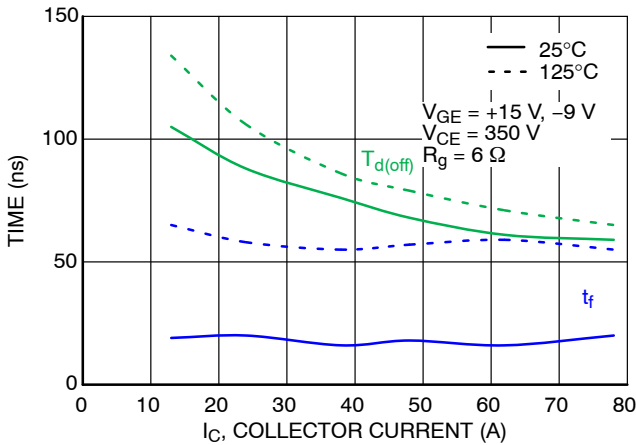

Figure 19. Typical Turn-Off Switching Time vs. IC

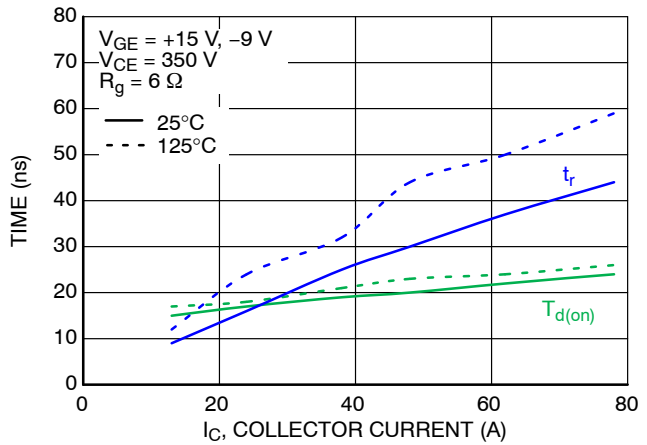

Figure 20. Typical Turn-On Switching Time vs. IC

NXH50M65L4Q1SG, NXH50M65L4Q1PTG

TYPICAL CHARACTERISTICS – (T21, T22) IGBT COMMUTATES D20 DIODE (CONTINUED)

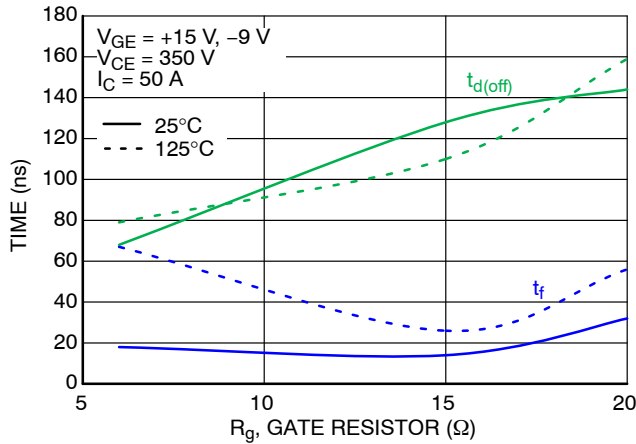

Figure 21. Typical Turn-Off Switching Time vs. Rg

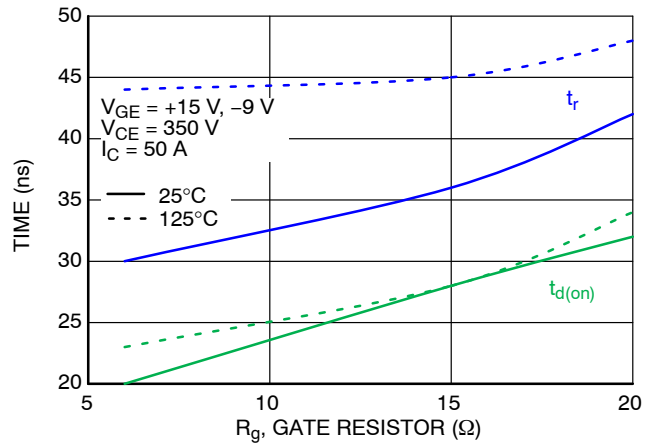

Figure 22. Typical Turn-On Switching Time vs. Rg

TYPICAL CHARACTERISTICS – DIODE

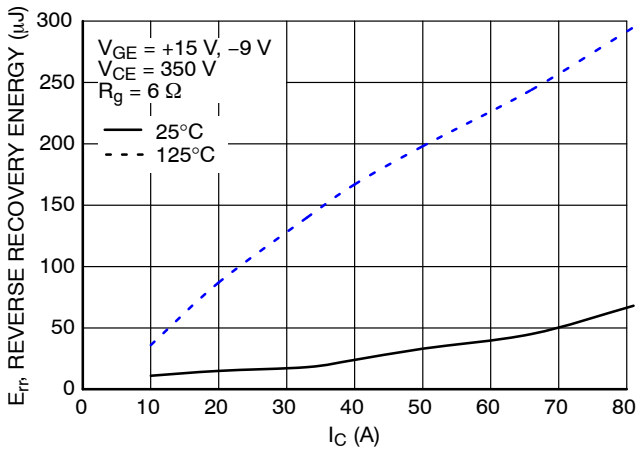

Figure 23. Typical Reverse Recovery Energy Loss vs. IC

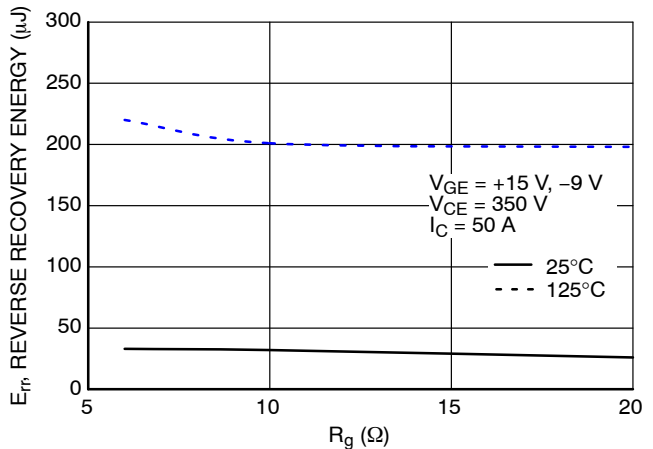

Figure 24. Typical Reverse Recovery Energy Loss vs. Rg

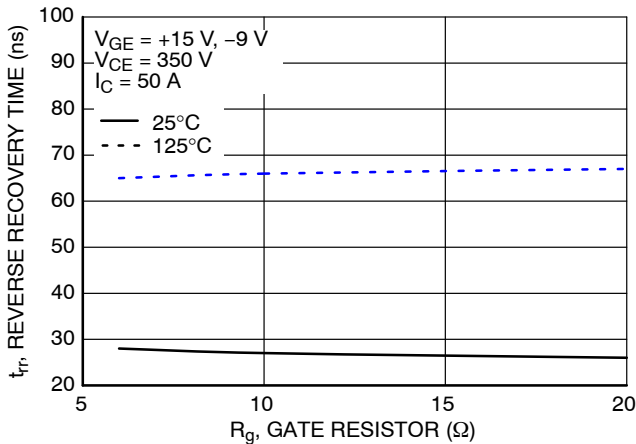

Figure 25. Typical Reverse Recovery Time vs. Rg

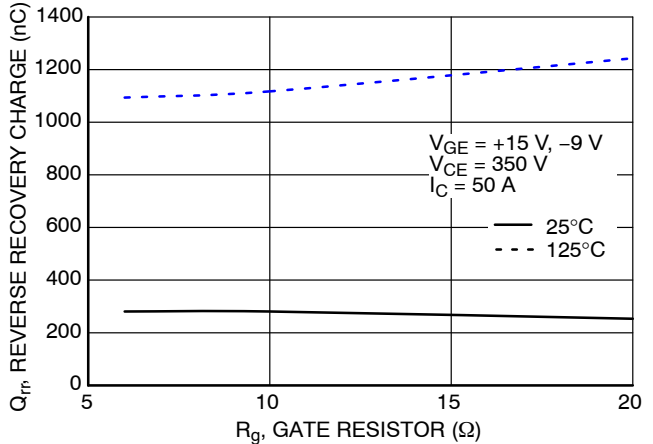

Figure 26. Typical Reverse Recovery Charge vs. Rg

NXH50M65L4Q1SG, NXH50M65L4Q1PTG

TYPICAL CHARACTERISTICS – DIODE (CONTINUED)

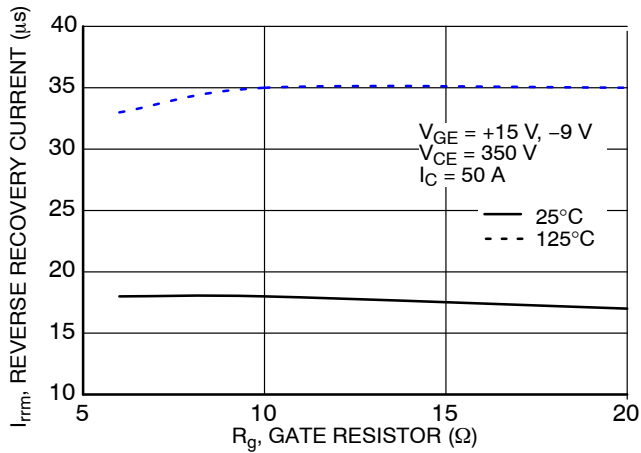

Figure 27. Typical Reverse Recovery Peak Current vs. Rg

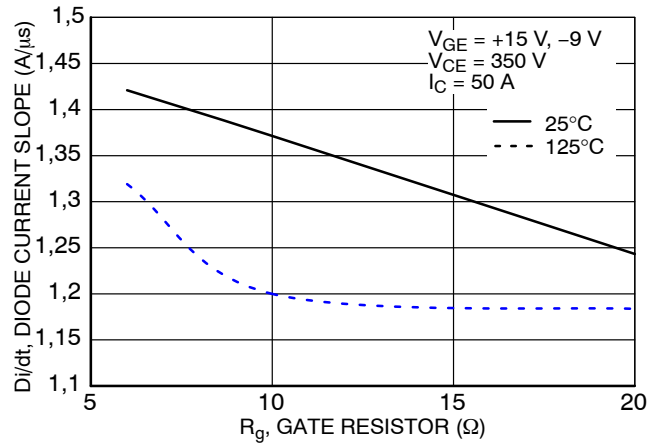

Figure 28. Typical di/dt vs. Rg

TYPICAL CHARACTERISTICS

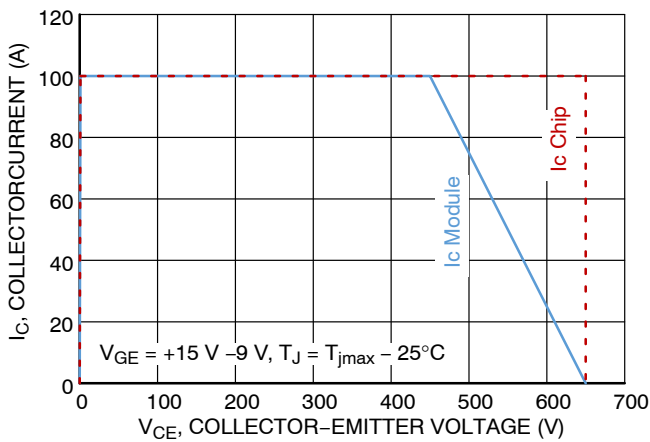

Figure 29. RBSOA Reverse Safe Operating Area

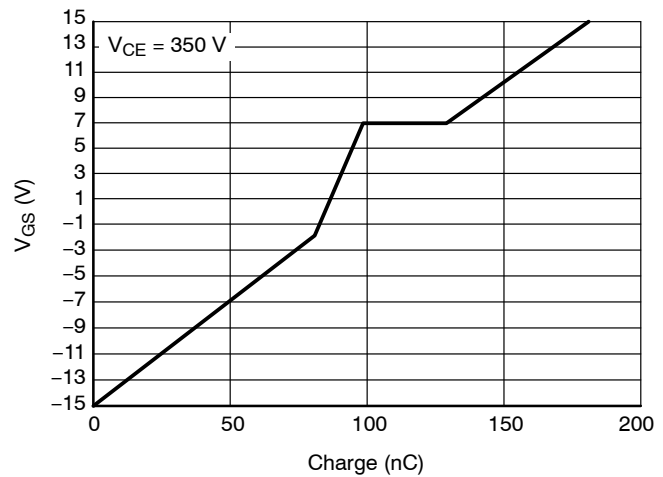

Figure 30. IGBT Gate Charge

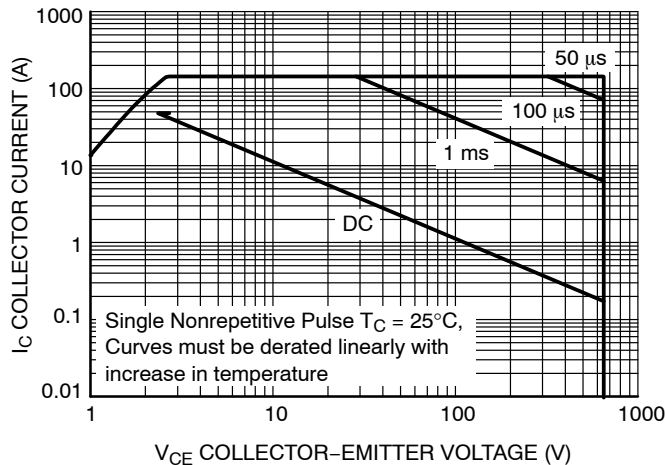

Figure 31. IGBT Safe Operating Area

NXH50M65L4Q1SG, NXH50M65L4Q1PTG

TYPICAL THERMAL CHARACTERISTICS

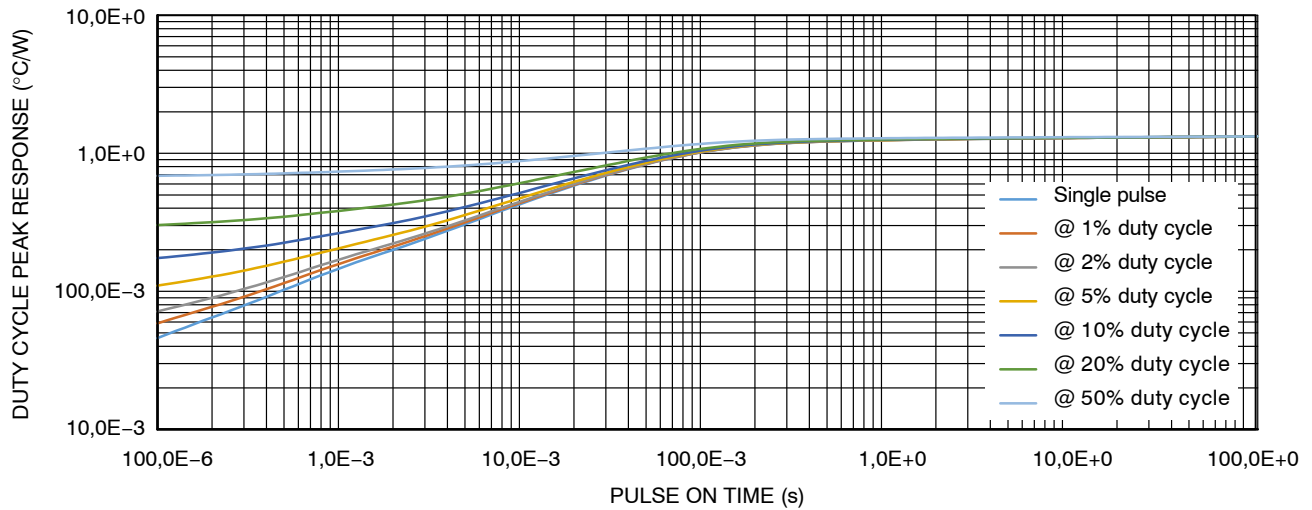

Figure 32. Transient Thermal Impedance – IGBT

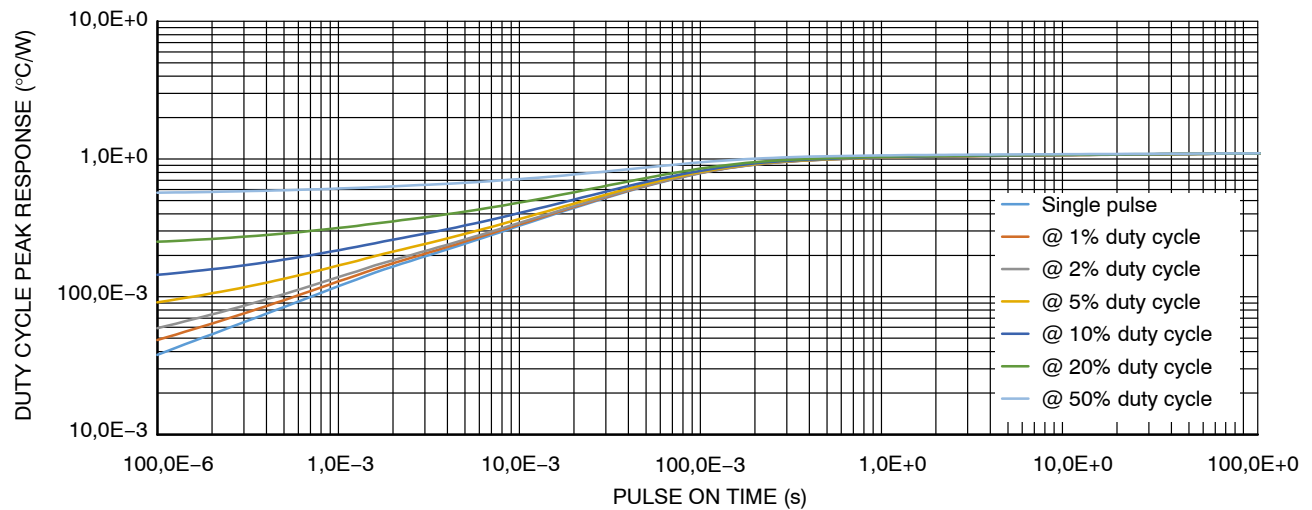

Figure 33. Transient Thermal Impedance – Diode

ORDERING INFORMATION

| Device | Package Type | Status | Shipping |
|--------------------------------|-----------------------|----------------|------------------|
| NXH50M65L4Q1SG (Solder Pin) | PIM27, 71x37.4 Q1PACK | In Development | 21 Units / BTRAY |
| NXH50M65L4Q1PTG (Pressfit Pin) | PIM27, 71x37.4 Q1PACK | In Development | 21 Units / BTRAY |

MECHANICAL CASE OUTLINE PACKAGE DIMENSIONS



PIM27, 71x37.4 (SOLDER PIN)
CASE 180CA
ISSUE B

DATE 14 DEC 2022

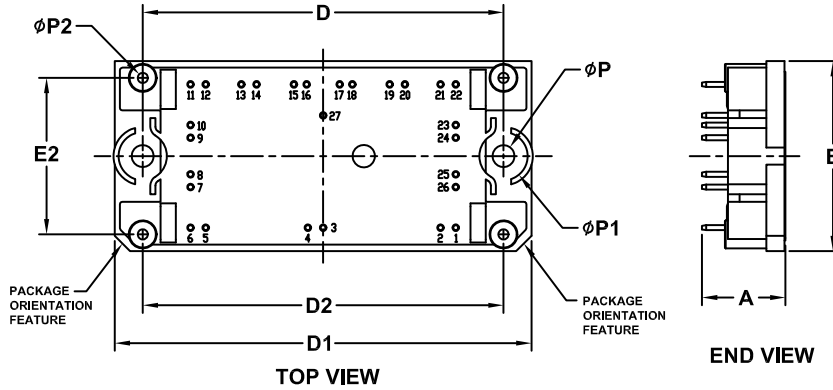
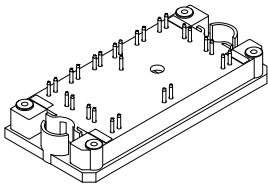

| DIM | MILLIMETERS | | |
|-----|-------------|-------|-------|
| | MIN. | NOM. | MAX. |
| A | 15.90 | 16.40 | 16.90 |
| A2 | 11.70 | 11.90 | 12.10 |
| A3 | 0.00 | 0.20 | 0.60 |
| b | 0.95 | 1.00 | 1.05 |
| b1 | 0.75 | 0.80 | 0.85 |
| D | 70.80 | 71.00 | 71.20 |
| D1 | 81.70 | 82.00 | 82.30 |
| D2 | 70.80 | 71.00 | 71.20 |
| E | 37.10 | 37.40 | 37.70 |
| E2 | 30.60 | 30.80 | 31.00 |
| P | 4.10 | 4.30 | 4.50 |
| P1 | 9.30 | 9.50 | 9.70 |
| P2 | 1.80 | 2.00 | 2.20 |

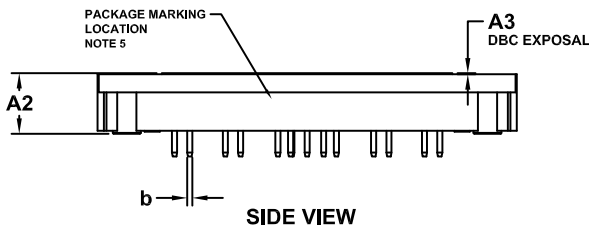

NOTE 4

| PIN | PIN POSITION | | PIN | PIN POSITION | |
|-----|--------------|-------|-----|--------------|-------|
| | X | Y | | X | Y |
| 1 | 52.20 | 0.00 | 15 | 20.35 | 28.20 |
| 2 | 49.20 | 0.00 | 16 | 22.85 | 28.20 |
| 3 | 26.10 | 0.00 | 17 | 29.35 | 28.20 |
| 4 | 23.10 | 0.00 | 18 | 31.85 | 28.20 |
| 5 | 3.00 | 0.00 | 19 | 39.20 | 28.20 |
| 6 | 0.00 | 0.00 | 20 | 42.20 | 28.20 |
| 7 | 0.00 | 8.00 | 21 | 49.20 | 28.20 |
| 8 | 0.00 | 10.50 | 22 | 52.20 | 28.20 |
| 9 | 0.00 | 17.70 | 23 | 52.20 | 20.20 |
| 10 | 0.00 | 20.20 | 24 | 52.20 | 17.70 |
| 11 | 0.00 | 28.20 | 25 | 52.20 | 10.50 |
| 12 | 3.00 | 28.20 | 26 | 52.20 | 8.00 |
| 13 | 10.00 | 28.20 | 27 | 26.10 | 22.10 |
| 14 | 13.00 | 28.20 | | | |

NOTES:

1. DIMENSIONING AND TOLERANCING PER ASME Y14.5M, 2009
2. CONTROLLING DIMENSION : MILLIMETERS
3. DIMENSIONS b AND b1 APPLY TO THE PLATED TERMINALS AND ARE MEASURED AT DIMENSION A1
4. PIN POSITION TOLERANCE IS $\pm 0.4\text{mm}$
5. PACKAGE MARKING IS LOCATED AS SHOWN ON THE SIDE OPPOSITE THE PACKAGE ORIENTATION FEATURES

| | | |
|------------------|-----------------------------|--|
| DOCUMENT NUMBER: | 98AON20006H | Electronic versions are uncontrolled except when accessed directly from the Document Repository. Printed versions are uncontrolled except when stamped "CONTROLLED COPY" in red. |
| DESCRIPTION: | PIM27, 71X37.4 (SOLDER PIN) | PAGE 1 OF 2 |

onsemi and ONSEMI are trademarks of Semiconductor Components Industries, LLC dba onsemi or its subsidiaries in the United States and/or other countries. onsemi reserves the right to make changes without further notice to any products herein. onsemi makes no warranty, representation or guarantee regarding the suitability of its products for any particular purpose, nor does onsemi assume any liability arising out of the application or use of any product or circuit, and specifically disclaims any and all liability, including without limitation special, consequential or incidental damages. onsemi does not convey any license under its patent rights nor the rights of others.

MECHANICAL CASE OUTLINE
PACKAGE DIMENSIONS



PIM27, 71x37.4 (SOLDER PIN)
CASE 180CA
ISSUE B

DATE 14 DEC 2022

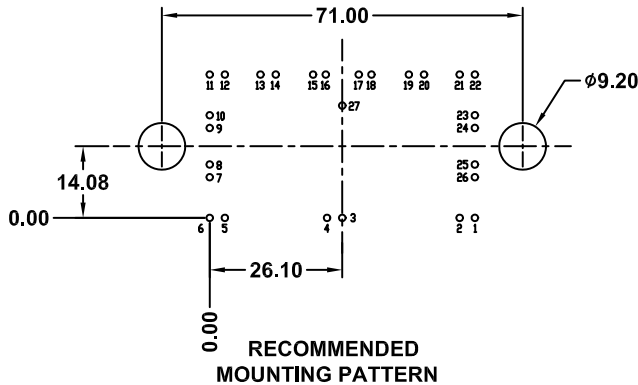

* For additional information on our Pb-Free strategy and soldering details, please download the ON Semiconductor Soldering and Mounting Techniques Reference Manual, SOLDERRM/D.

GENERIC MARKING DIAGRAM*

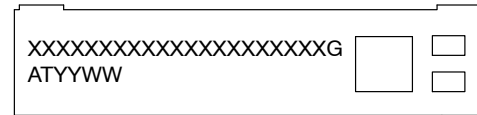

FRONTSIDE MARKING

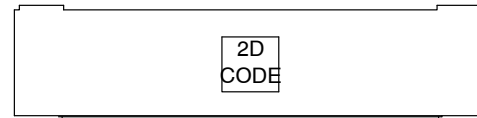

BACKSIDE MARKING

XXXXX = Specific Device Code
 G = Pb-Free Device
 AT = Assembly & Test Site Code
 YYWW = Year and Work Week Code

*This information is generic. Please refer to device data sheet for actual part marking. Pb-Free indicator, "G" or microdot "•", may or may not be present. Some products may not follow the Generic Marking.

| | | |
|-------------------------|------------------------------------|--|
| DOCUMENT NUMBER: | 98AON20006H | Electronic versions are uncontrolled except when accessed directly from the Document Repository. Printed versions are uncontrolled except when stamped "CONTROLLED COPY" in red. |
| DESCRIPTION: | PIM27, 71X37.4 (SOLDER PIN) | PAGE 2 OF 2 |

onsemi and onsemi are trademarks of Semiconductor Components Industries, LLC dba onsemi or its subsidiaries in the United States and/or other countries. onsemi reserves the right to make changes without further notice to any products herein. onsemi makes no warranty, representation or guarantee regarding the suitability of its products for any particular purpose, nor does onsemi assume any liability arising out of the application or use of any product or circuit, and specifically disclaims any and all liability, including without limitation special, consequential or incidental damages. onsemi does not convey any license under its patent rights nor the rights of others.

MECHANICAL CASE OUTLINE PACKAGE DIMENSIONS



PIM27, 71x37.4 (PRESSFIT PIN) CASE 180CP ISSUE A

DATE 20 DEC 2022

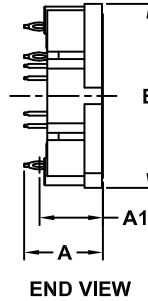
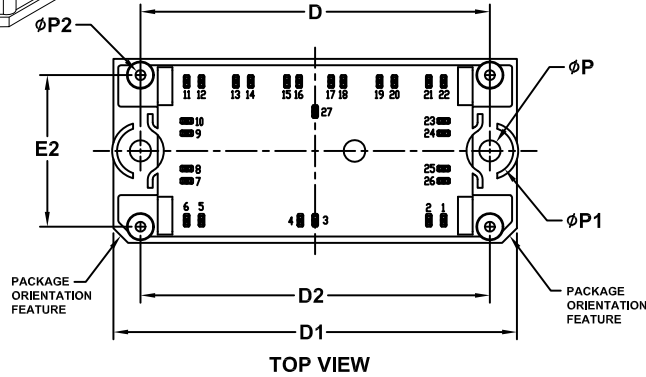
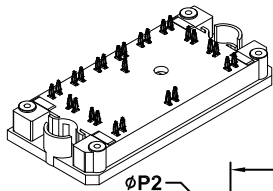

| DIM | MILLIMETERS | | |
|-----|-------------|-------|-------|
| | MIN. | NOM. | MAX. |
| A | 15.50 | 16.00 | 16.50 |
| A1 | 12.38 | 12.88 | 13.38 |
| A2 | 11.70 | 11.90 | 12.10 |
| A3 | 0.00 | 0.20 | 0.60 |
| b | 1.61 | 1.66 | 1.71 |
| b1 | 0.75 | 0.80 | 0.85 |
| D | 70.80 | 71.00 | 71.20 |
| D1 | 81.70 | 82.00 | 82.30 |
| D2 | 70.80 | 71.00 | 71.20 |
| E | 37.10 | 37.40 | 37.70 |
| E2 | 30.60 | 30.80 | 31.00 |
| P | 4.10 | 4.30 | 4.50 |
| P1 | 9.30 | 9.50 | 9.70 |
| P2 | 1.80 | 2.00 | 2.20 |

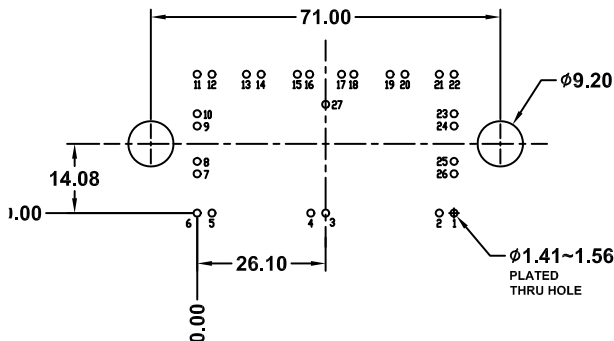
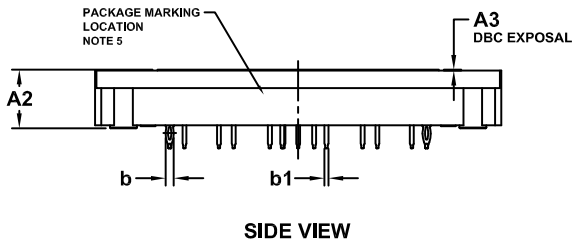

NOTE 4

| PIN | PIN POSITION | | PIN | PIN POSITION | |
|-----|--------------|-------|-----|--------------|-------|
| | X | Y | | X | Y |
| 1 | 52.20 | 0.00 | 15 | 20.35 | 28.20 |
| 2 | 49.20 | 0.00 | 16 | 22.85 | 28.20 |
| 3 | 26.10 | 0.00 | 17 | 29.35 | 28.20 |
| 4 | 23.10 | 0.00 | 18 | 31.85 | 28.20 |
| 5 | 3.00 | 0.00 | 19 | 39.20 | 28.20 |
| 6 | 0.00 | 0.00 | 20 | 42.20 | 28.20 |
| 7 | 0.00 | 8.00 | 21 | 49.20 | 28.20 |
| 8 | 0.00 | 10.50 | 22 | 52.20 | 28.20 |
| 9 | 0.00 | 17.70 | 23 | 52.20 | 20.20 |
| 10 | 0.00 | 20.20 | 24 | 52.20 | 17.70 |
| 11 | 0.00 | 28.20 | 25 | 52.20 | 10.50 |
| 12 | 3.00 | 28.20 | 26 | 52.20 | 8.00 |
| 13 | 10.00 | 28.20 | 27 | 26.10 | 22.10 |
| 14 | 13.00 | 28.20 | | | |

* For additional information on our Pb-Free strategy and soldering details, please download the ON Semiconductor Soldering and Mounting Techniques Reference Manual, SOLDERRM/D.

NOTES:

1. DIMENSIONING AND TOLERANCING PER ASME Y14.5M, 2009
2. CONTROLLING DIMENSION : MILLIMETERS
3. DIMENSIONS b AND b1 APPLY TO THE PLATED TERMINALS AND ARE MEASURED AT DIMENSION A1
4. PIN POSITION TOLERANCE IS $\pm 0.4\text{mm}$
5. PACKAGE MARKING IS LOCATED AS SHOWN ON THE SIDE OPPOSITE THE PACKAGE ORIENTATION FEATURES

GENERIC MARKING DIAGRAM*

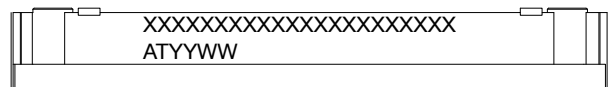

XXXXX = Specific Device Code
AT = Assembly & Test Site Code
YYWW = Year and Work Week Code

*This information is generic. Please refer to device data sheet for actual part marking. Pb-Free indicator, "G" or microdot "▪", may or may not be present. Some products may not follow the Generic Marking.

| | | |
|------------------|-------------------------------|--|
| DOCUMENT NUMBER: | 98AON26650H | Electronic versions are uncontrolled except when accessed directly from the Document Repository. Printed versions are uncontrolled except when stamped "CONTROLLED COPY" in red. |
| DESCRIPTION: | PIM27, 71X37.4 (PRESSFIT PIN) | PAGE 1 OF 1 |

onsemi and onsemi are trademarks of Semiconductor Components Industries, LLC dba onsemi or its subsidiaries in the United States and/or other countries. onsemi reserves the right to make changes without further notice to any products herein. onsemi makes no warranty, representation or guarantee regarding the suitability of its products for any particular purpose, nor does onsemi assume any liability arising out of the application or use of any product or circuit, and specifically disclaims any and all liability, including without limitation special, consequential or incidental damages. onsemi does not convey any license under its patent rights nor the rights of others.

onsemi, **Onsemi**, and other names, marks, and brands are registered and/or common law trademarks of Semiconductor Components Industries, LLC dba "**onsemi**" or its affiliates and/or subsidiaries in the United States and/or other countries. **onsemi** owns the rights to a number of patents, trademarks, copyrights, trade secrets, and other intellectual property. A listing of **onsemi**'s product/patent coverage may be accessed at www.onsemi.com/site/pdf/Patent-Marking.pdf. **onsemi** reserves the right to make changes at any time to any products or information herein, without notice. The information herein is provided "as-is" and **onsemi** makes no warranty, representation or guarantee regarding the accuracy of the information, product features, availability, functionality, or suitability of its products for any particular purpose, nor does **onsemi** assume any liability arising out of the application or use of any product or circuit, and specifically disclaims any and all liability, including without limitation special, consequential or incidental damages. Buyer is responsible for its products and applications using **onsemi** products, including compliance with all laws, regulations and safety requirements or standards, regardless of any support or applications information provided by **onsemi**. "Typical" parameters which may be provided in **onsemi** data sheets and/or specifications can and do vary in different applications and actual performance may vary over time. All operating parameters, including "Typicals" must be validated for each customer application by customer's technical experts. **onsemi** does not convey any license under any of its intellectual property rights nor the rights of others. **onsemi** products are not designed, intended, or authorized for use as a critical component in life support systems or any FDA Class 3 medical devices or medical devices with a same or similar classification in a foreign jurisdiction or any devices intended for implantation in the human body. Should Buyer purchase or use **onsemi** products for any such unintended or unauthorized application, Buyer shall indemnify and hold **onsemi** and its officers, employees, subsidiaries, affiliates, and distributors harmless against all claims, costs, damages, and expenses, and reasonable attorney fees arising out of, directly or indirectly, any claim of personal injury or death associated with such unintended or unauthorized use, even if such claim alleges that **onsemi** was negligent regarding the design or manufacture of the part. **onsemi** is an Equal Opportunity/Affirmative Action Employer. This literature is subject to all applicable copyright laws and is not for resale in any manner.

ADDITIONAL INFORMATION

TECHNICAL PUBLICATIONS:

Technical Library: www.onsemi.com/design/resources/technical-documentation
onsemi Website: www.onsemi.com

ONLINE SUPPORT: www.onsemi.com/support

For additional information, please contact your local Sales Representative at www.onsemi.com/support/sales