

F2 Boost Power Module

NXH200B100H4F2SG, NXH200B100H4F2SG-R

The NXH200B100H4F2SG is a power module containing high-performance IGBTs with rugged anti-parallel diodes. The module also contains an on-board thermistor.

Features

- Extremely Efficient Trench with Field Stop Technology
- Low Switching Loss Reduces System Power Dissipation
- F2 Package with Solder Pins

Typical Applications

- Solar Inverter
- Uninterruptible Power Supplies

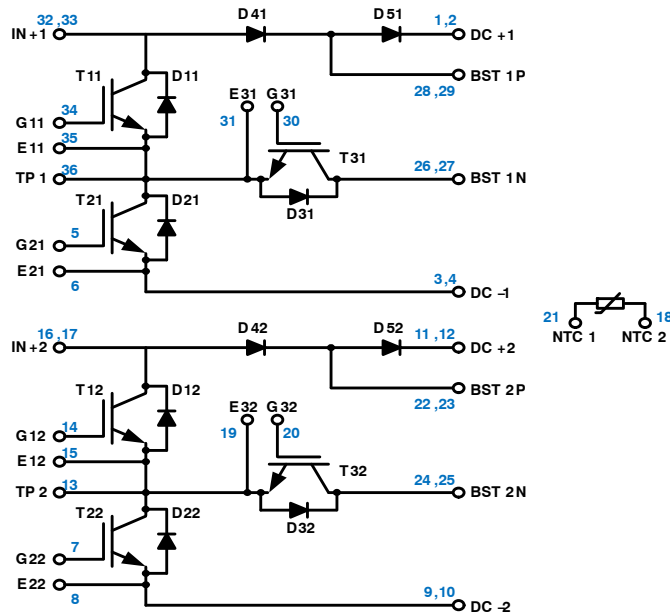
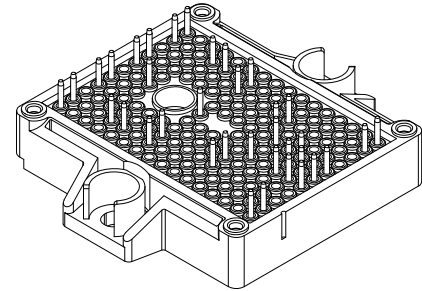
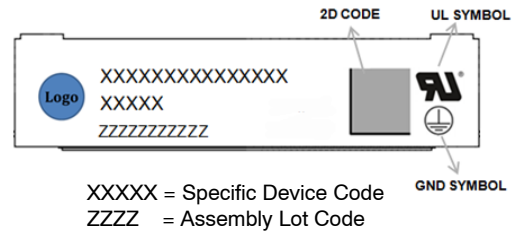

Figure 1.
NXH200B100H4F2SG/NXH200B100H4F2SG-R
Schematic Diagram



F2 PACKAGE
CASE 180CJ
SOLDER PINS

MARKING DIAGRAM



PIN CONNECTIONS

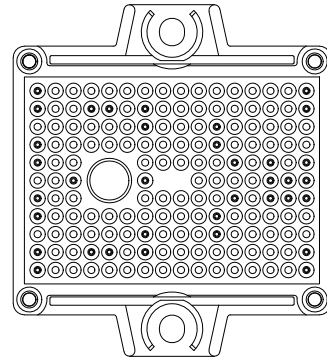

ORDERING INFORMATION

See detailed ordering and shipping information on page 5 of this data sheet.

NXH200B100H4F2SG, NXH200B100H4F2SG-R

Table 1. ABSOLUTE MAXIMUM RATINGS (Note 1) $T_J = 25^\circ\text{C}$ unless otherwise noted

Rating	Symbol	Value	Unit
BOOST IGBT (T11, T21, T12, T22)			
Collector-Emitter Voltage	V_{CES}	1000	V
Gate-Emitter Voltage	V_{GE}	± 20	V
Continuous Collector Current @ $T_h = 80^\circ\text{C}$	I_C	100	A
Pulsed Collector Current	I_{Cpulse}	300	A
Maximum Power Dissipation @ $T_h = 80^\circ\text{C}$	P_{tot}	93	W
Minimum Operating Junction Temperature	T_{JMIN}	-40	$^\circ\text{C}$
Maximum Operating Junction Temperature	T_{JMAX}	150	$^\circ\text{C}$
BOOST IGBT INVERSE DIODE (D11, D21, D12, D22)			
Peak Repetitive Reverse Voltage	V_{RRM}	1600	V
Continuous Forward Current @ $T_h = 80^\circ\text{C}$	I_F	30	A
Repetitive Peak Forward Current, $T_{pulse} = 1\text{ ms}$	I_{FRM}	90	A
Power Dissipation Per Diode @ $T_h = 80^\circ\text{C}$	P_{tot}	37	W
Minimum Operating Junction Temperature	T_{JMIN}	-40	$^\circ\text{C}$
Maximum Operating Junction Temperature	T_{JMAX}	150	$^\circ\text{C}$
PATH IGBT (T31, T32)			
Collector-Emitter Voltage	V_{CES}	1000	V
Gate-Emitter Voltage	V_{GE}	± 20	V
Continuous Collector Current @ $T_h = 80^\circ\text{C}$	I_C	100	A
Pulsed Collector Current	I_{Cpulse}	300	A
Maximum Power Dissipation @ $T_h = 80^\circ\text{C}$	P_{tot}	109	W
Minimum Operating Junction Temperature	T_{JMIN}	-40	$^\circ\text{C}$
Maximum Operating Junction Temperature	T_{JMAX}	150	$^\circ\text{C}$
PATH IGBT INVERSE DIODE (D31, D32)			
Peak Repetitive Reverse Voltage	V_{RRM}	1200	V
Continuous Forward Current @ $T_h = 80^\circ\text{C}$	I_F	40	A
Repetitive Peak Forward Current	I_{FRM}	120	A
Power Dissipation Per Diode @ $T_h = 80^\circ\text{C}$	P_{tot}	78	W
Minimum Operating Junction Temperature	T_{JMIN}	-40	$^\circ\text{C}$
Maximum Operating Junction Temperature	T_{JMAX}	150	$^\circ\text{C}$
BOOST DIODE (D41, D51, D42, D52)			
Peak Repetitive Reverse Voltage	V_{RRM}	1200	V
Continuous Forward Current @ $T_h = 80^\circ\text{C}$	I_F	40	A
Repetitive Peak Forward Current, $T_{pulse} = 1\text{ ms}$	I_{FRM}	120	A
Maximum Power Dissipation @ $T_h = 80^\circ\text{C}$	P_{tot}	72	W
Minimum Operating Junction Temperature	T_{JMIN}	-40	$^\circ\text{C}$
Maximum Operating Junction Temperature	T_{JMAX}	150	$^\circ\text{C}$
THERMAL PROPERTIES			
Storage Temperature range	T_{stg}	-40 to 125	$^\circ\text{C}$
INSULATION PROPERTIES			
Isolation test voltage, $t = 1\text{ sec}$, 50 Hz	V_{is}	3000	V_{RMS}
Creepage distance (pin to heatsink)		>12.7	mm

Stresses exceeding those listed in the Maximum Ratings table may damage the device. If any of these limits are exceeded, device functionality should not be assumed, damage may occur and reliability may be affected.

1. Refer to ELECTRICAL CHARACTERISTICS, RECOMMENDED OPERATING RANGES and/or APPLICATION INFORMATION for Safe Operating parameters.

NXH200B100H4F2SG, NXH200B100H4F2SG-R

Table 2. RECOMMENDED OPERATING RANGES

Rating	Symbol	Min	Max	Unit
Module Operating Junction Temperature	T_J	-40	150	°C

Functional operation above the stresses listed in the Recommended Operating Ranges is not implied. Extended exposure to stresses beyond the Recommended Operating Ranges limits may affect device reliability.

Table 3. ELECTRICAL CHARACTERISTICS $T_J = 25^\circ\text{C}$ unless otherwise noted

Parameter	Test Conditions	Symbol	Min	Typ	Max	Unit
BOOST IGBT CHARACTERISTICS (T11, T21, T12, T22)						
Collector-Emitter Cutoff Current	$V_{GE} = 0\text{ V}, V_{CE} = 1000\text{ V}$	I_{CES}	-	-	200	μA
Collector-Emitter Saturation Voltage	$V_{GE} = 15\text{ V}, I_C = 100\text{ A}, T_J = 25^\circ\text{C}$	$V_{CE(sat)}$	-	1.8	2.4	V
	$V_{GE} = 15\text{ V}, I_C = 100\text{ A}, T_J = 150^\circ\text{C}$		-	2.1	-	
Gate-Emitter Threshold Voltage	$V_{GE} = V_{CE}, I_C = 100\text{ mA}$	$V_{GE(TH)}$	3.9	5	6.3	V
Gate Leakage Current	$V_{GE} = 20\text{ V}, V_{CE} = 0\text{ V}$	I_{GES}	-	-	800	nA
Turn-on Switching Loss per Pulse	$T_J = 25^\circ\text{C}$ $V_{CE} = 600\text{ V}, I_C = 30\text{ A}$ $V_{GE} = -5\text{ V} \sim 15\text{ V}, R_G = 10\ \Omega$	E_{on}	-	0.57	-	mJ
Turn-off Switching Loss per Pulse		E_{off}	-	0.96	-	
Turn-on Switching Loss per Pulse	$T_J = 125^\circ\text{C}$ $V_{CE} = 600\text{ V}, I_C = 30\text{ A}$ $V_{GE} = -5\text{ V} \sim 15\text{ V}, R_G = 10\ \Omega$	E_{on}	-	0.70	-	mJ
Turn-off Switching Loss per Pulse		E_{off}	-	1.60	-	
Input Capacitance	$V_{CE} = 20\text{ V}, V_{GE} = 0\text{ V}, f = 1\text{ MHz}$	C_{ies}	-	6523	-	pF
Output Capacitance		C_{oes}	-	253	-	
Reverse Transfer Capacitance		C_{res}	-	26	-	
Total Gate Charge	$V_{CE} = 600\text{ V}, I_C = 100\text{ A}, V_{GE} = \pm 15\text{ V}$	Q_g	-	326	-	nC
Thermal Resistance – chip-to-case		R_{thJC}	-	0.42	-	°C/W
Thermal Resistance – chip-to-heatsink	Thermal grease, Thickness $\approx 57\ \mu\text{m}$, $\lambda = 2.87\text{ W/mK}$	R_{thJH}	-	0.75	-	°C/W

BOOST IGBT INVERSE DIODE CHARACTERISTICS (D11, D21, D12, D22)

Diode Forward Voltage	$I_F = 30\text{ A}, T_J = 25^\circ\text{C}$	V_F	-	1	1.6	V
	$I_F = 30\text{ A}, T_J = 150^\circ\text{C}$		-	0.94	-	
Thermal Resistance – chip-to-case		R_{thJC}	-	0.77	-	°C/W
Thermal Resistance – chip-to-heatsink	Thermal grease, Thickness $\approx 57\ \mu\text{m}$, $\lambda = 2.87\text{ W/mK}$	R_{thJH}	-	1.19	-	°C/W

PATH IGBT CHARACTERISTICS (T31, T32)

Collector-Emitter Cutoff Current	$V_{GE} = 0\text{ V}, V_{CE} = 1000\text{ V}$	I_{CES}	-	-	200	μA
Collector-Emitter Saturation Voltage	$V_{GE} = 15\text{ V}, I_C = 100\text{ A}, T_J = 25^\circ\text{C}$	$V_{CE(sat)}$	-	1.26	2.1	V
	$V_{GE} = 15\text{ V}, I_C = 100\text{ A}, T_J = 150^\circ\text{C}$		-	1.34	-	
Gate-Emitter Threshold Voltage	$V_{GE} = V_{CE}, I_C = 100\text{ mA}$	$V_{GE(TH)}$	3.2	4.6	5.5	V
Gate Leakage Current	$V_{GE} = 20\text{ V}, V_{CE} = 0\text{ V}$	I_{GES}	-	-	800	nA
Input Capacitance	$V_{CE} = 20\text{ V}, V_{GE} = 0\text{ V}, f = 1\text{ MHz}$	C_{ies}	-	20937	-	pF
Output Capacitance		C_{oes}	-	341	-	
Reverse Transfer Capacitance		C_{res}	-	158	-	
Total Gate Charge	$V_{CE} = 600\text{ V}, I_C = 100\text{ A}, V_{GE} = 15\text{ V}$	Q_g	-	1746	-	nC
Thermal Resistance – chip-to-case		R_{thJC}	-	0.33	-	°C/W
Thermal Resistance – chip-to-heatsink	Thermal grease, Thickness $\approx 57\ \mu\text{m}$, $\lambda = 2.87\text{ W/mK}$	R_{thJH}	-	0.64	-	°C/W

NXH200B100H4F2SG, NXH200B100H4F2SG-R

Table 3. ELECTRICAL CHARACTERISTICS $T_J = 25^\circ\text{C}$ unless otherwise noted

Parameter	Test Conditions	Symbol	Min	Typ	Max	Unit
PATH IGBT INVERSE DIODE CHARACTERISTICS (D31, D32)						
Diode Forward Voltage	$I_F = 40\text{ A}, T_J = 25^\circ\text{C}$	V_F	–	2.3	3	V
	$I_F = 40\text{ A}, T_J = 150^\circ\text{C}$		–	1.6	–	
Thermal Resistance – chip-to-case		R_{thJC}	–	0.6	–	$^\circ\text{C/W}$
Thermal Resistance – chip-to-heatsink	Thermal grease, Thickness $\approx 57\ \mu\text{m}$, $\lambda = 2.87\ \text{W/mK}$	R_{thJH}	–	0.9	–	$^\circ\text{C/W}$
BOOST DIODE CHARACTERISTICS (D41, D51, D42, D52)						
Diode Reverse Leakage Current	$V_R = 1200\text{ V}, T_J = 25^\circ\text{C}$	I_R	–	–	400	μA
Diode Forward Voltage	$I_F = 40\text{ A}, T_J = 25^\circ\text{C}$	V_F	–	1.5	2	V
	$I_F = 40\text{ A}, T_J = 150^\circ\text{C}$		–	2.0	–	
Peak Reverse Recovery Current	$T_J = 25^\circ\text{C}$ $V_{CE} = 600\text{ V}, I_C = 30\text{ A}$ $V_{GE} = -5\text{ V} \sim 15\text{ V}, R_G = 10\ \Omega$	I_{RRM}	–	10	–	A
Reverse Recovery Energy		E_{rr}	–	66	–	μJ
Peak Reverse Recovery Current	$T_J = 125^\circ\text{C}$ $V_{CE} = 600\text{ V}, I_C = 30\text{ A}$ $V_{GE} = -5\text{ V} \sim 15\text{ V}, R_G = 10\ \Omega$	I_{RRM}	–	9.9	–	A
Reverse Recovery Energy		E_{rr}	–	64	–	μJ
Thermal Resistance – chip-to-case		R_{thJC}	–	0.59	–	$^\circ\text{C/W}$
Thermal Resistance – chip-to-heatsink	Thermal grease, Thickness $\approx 57\ \mu\text{m}$, $\lambda = 2.87\ \text{W/mK}$	R_{thJH}	–	0.97	–	$^\circ\text{C/W}$

Product parametric performance is indicated in the Electrical Characteristics for the listed test conditions, unless otherwise noted. Product performance may not be indicated by the Electrical Characteristics if operated under different conditions.

Table 4. THERMISTOR CHARACTERISTICS

Parameter	Test Conditions	Symbol	Min	Typ	Max	Unit
Nominal resistance		R_{25}	–	22	–	$\text{k}\Omega$
Nominal resistance	$T = 100^\circ\text{C}$	R_{100}	–	1486	–	Ω
Deviation of R_{25}		$-R/R$	-5	–	5	%
Power dissipation		P_D	–	200	–	mW
Power dissipation constant			–	2	–	mW/K
B-value	$B(25/50)$, tolerance $\pm 3\%$		–	3950	–	K
B-value	$B(25/100)$, tolerance $\pm 3\%$		–	3998	–	K

Table 5. ORDERING INFORMATION

Orderable Part Number	Marking	Package	Shipping
NXH200B100H4F2SG, NXH200B100H4F2SG-R	NXH200B100H4F2SG, NXH200B100H4F2SG-R	F2 – Case 180CJ (Pb-Free and Halide-Free, Solder Pins)	20 Units / Blister Tray

NXH200B100H4F2SG, NXH200B100H4F2SG-R

TYPICAL CHARACTERISTICS – BOOST IGBT & INVERSE DIODE

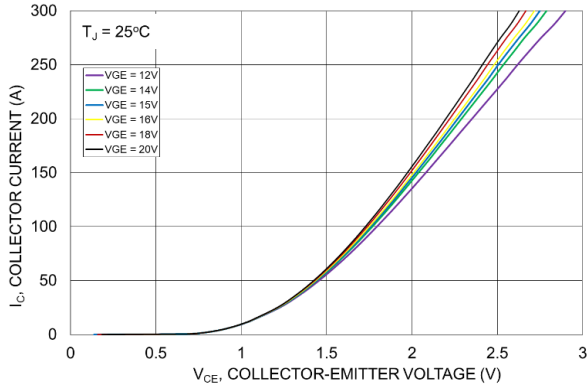

Figure 2. Typical Output Characteristics

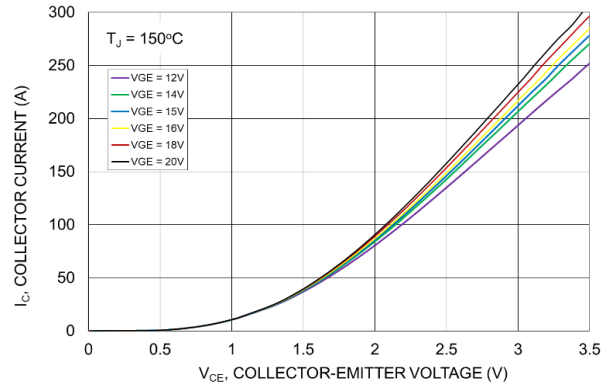

Figure 3. Typical Output Characteristics

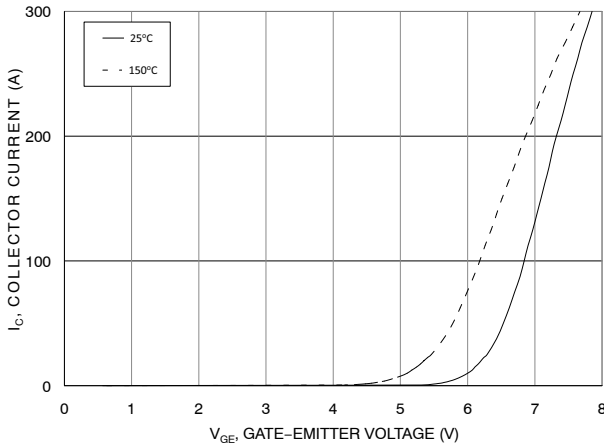

Figure 4. Typical Transfer Characteristics

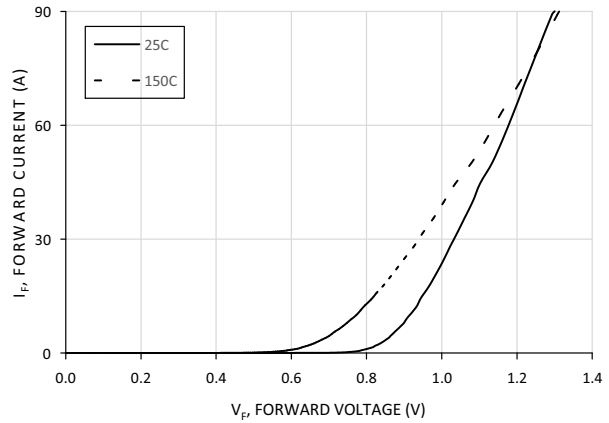

Figure 5. Inverse Diode Forward Characteristics

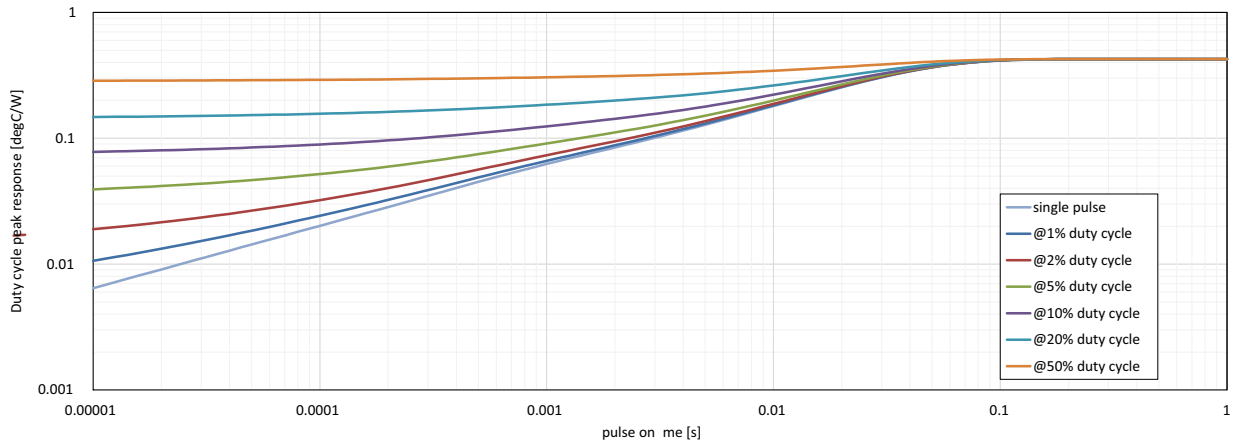

Figure 6. Boost IGBT Transient Thermal Impedance

NXH200B100H4F2SG, NXH200B100H4F2SG-R

TYPICAL CHARACTERISTICS – BOOST IGBT & INVERSE DIODE

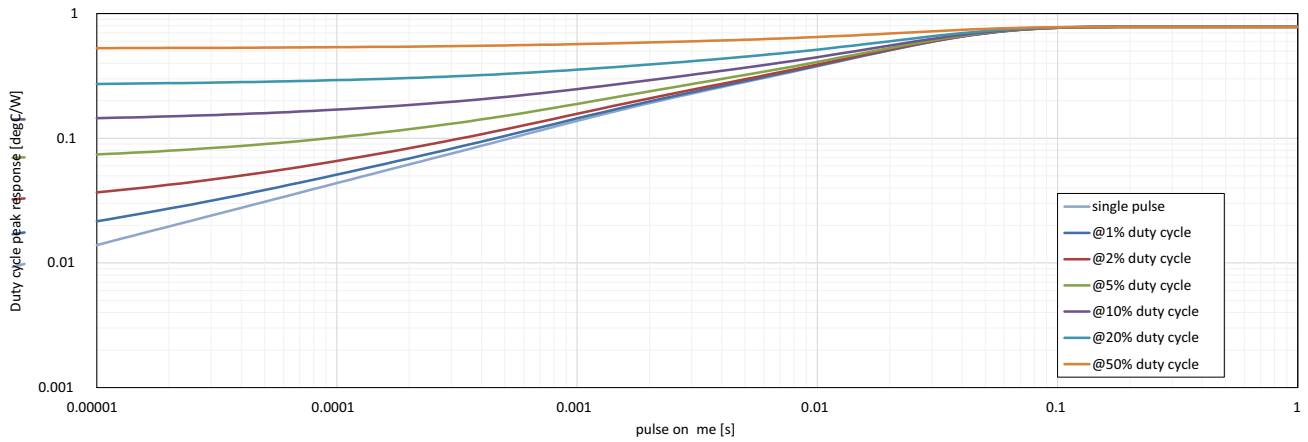

Figure 7. Inverse Diode Transient Thermal Impedance

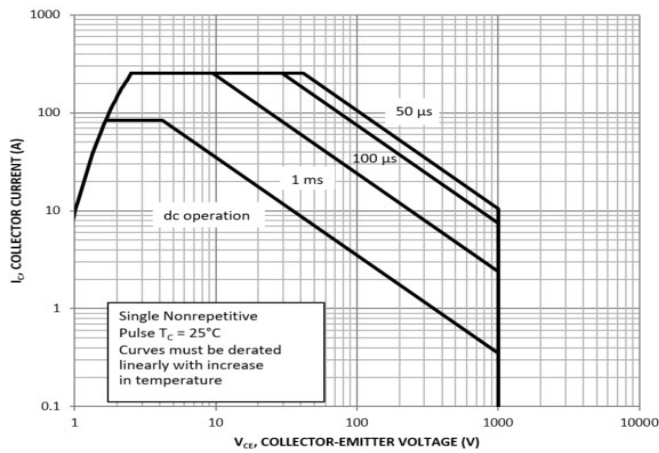

Figure 8. Boost IGBT FBSOA

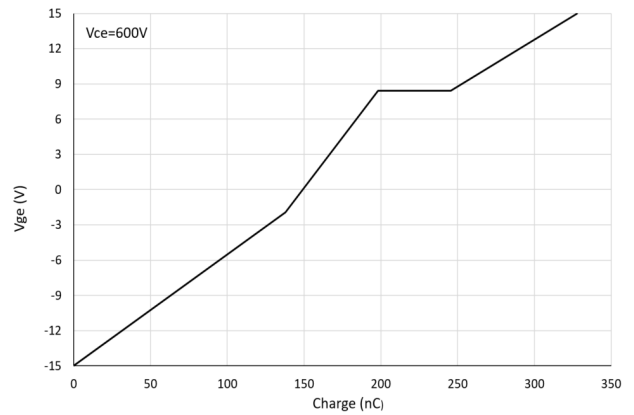

Figure 9. Boost IGBT Gate Voltage vs. Gate Charge

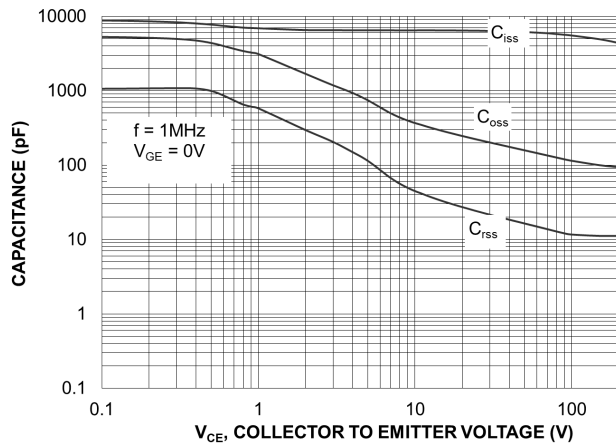

Figure 10. Boost IGBT Capacitance

NXH200B100H4F2SG, NXH200B100H4F2SG-R

TYPICAL CHARACTERISTICS – PATH IGBT & INVERSE DIODE

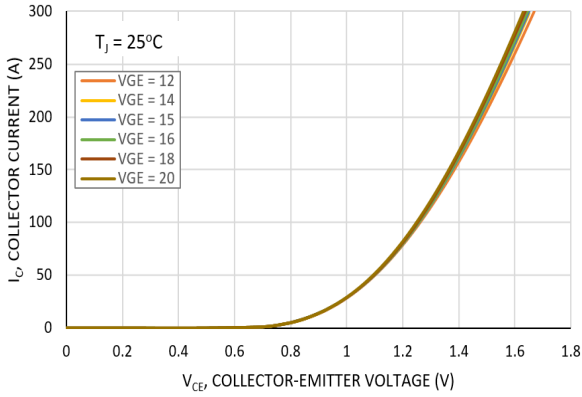

Figure 11. Typical Output Characteristics

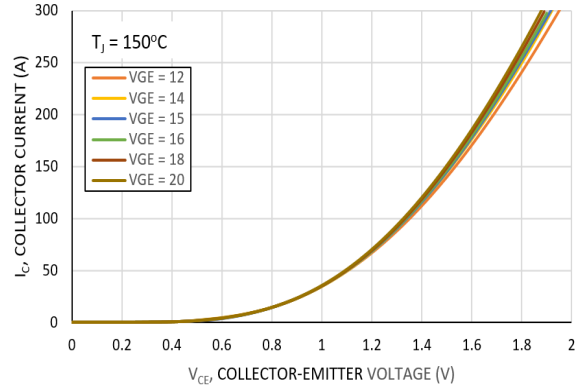

Figure 12. Typical Output Characteristics

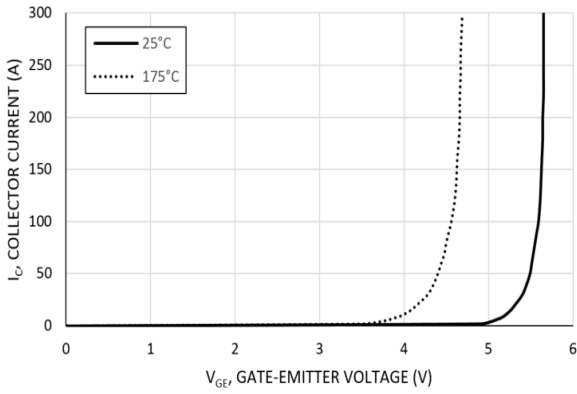

Figure 13. Typical Transfer Characteristics

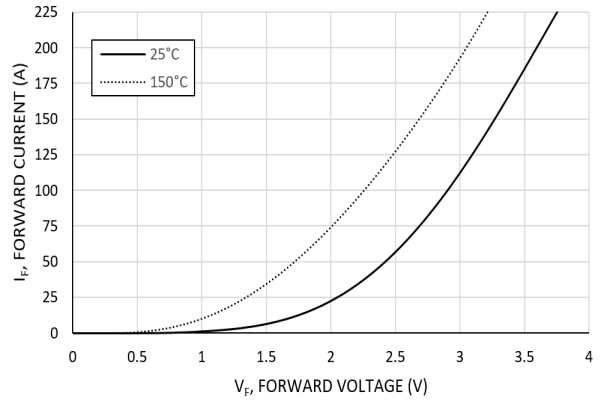

Figure 14. Inverse Diode Forward Characteristics

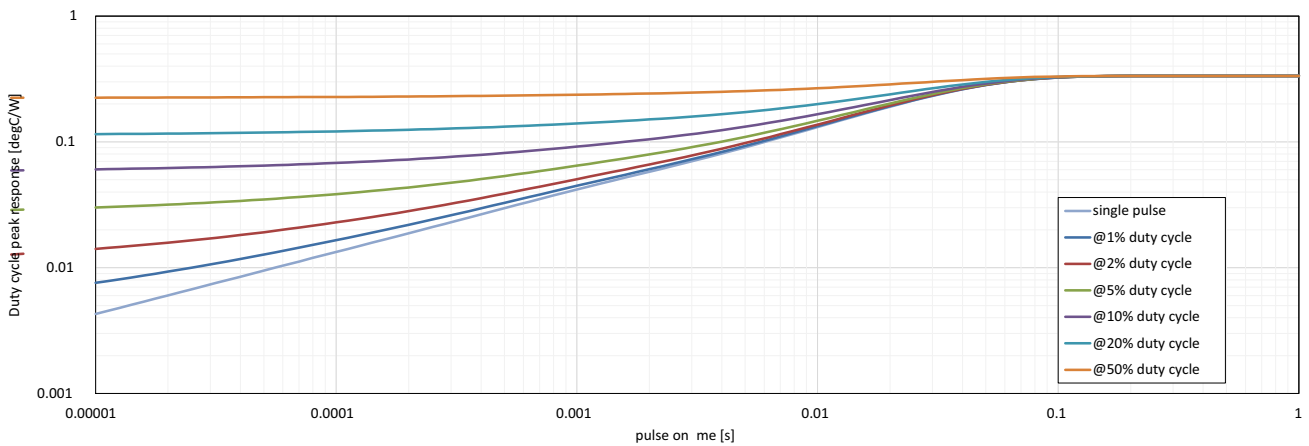

Figure 15. Path IGBT Transient Thermal Impedance

NXH200B100H4F2SG, NXH200B100H4F2SG-R

TYPICAL CHARACTERISTICS – PATH IGBT & INVERSE DIODE

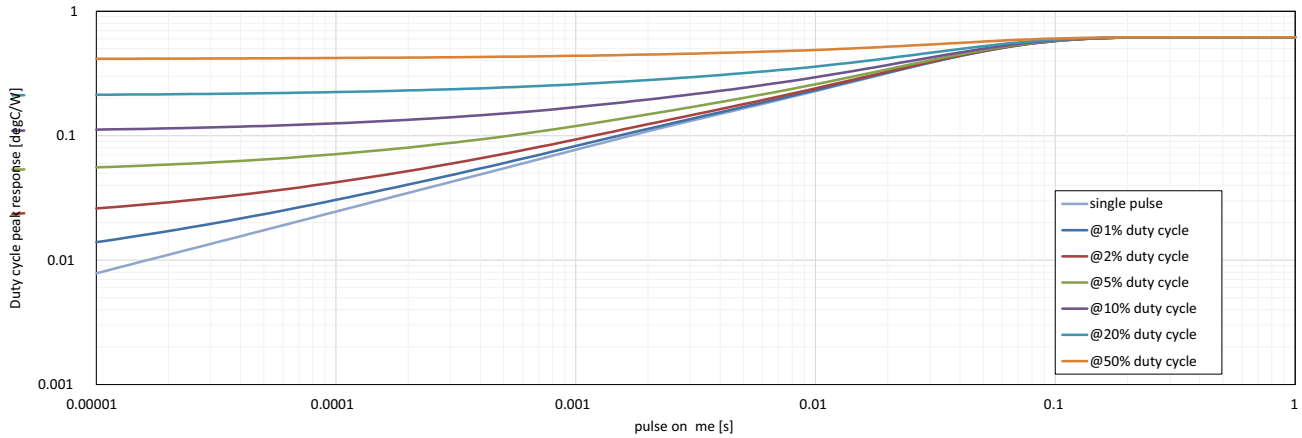

Figure 16. Inverse Diode Transient Thermal Impedance

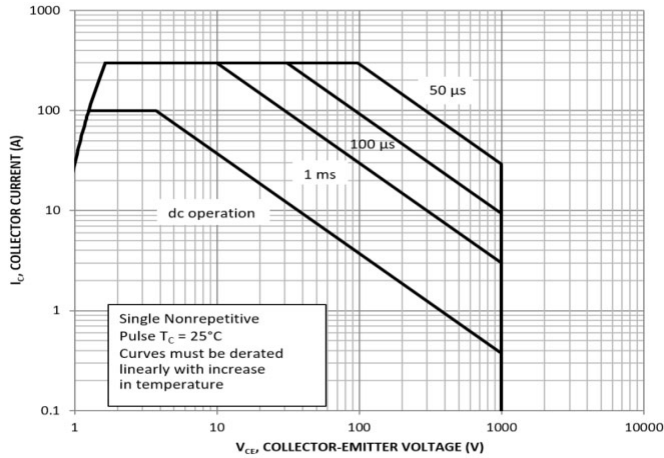

Figure 17. Path IGBT FBSOA

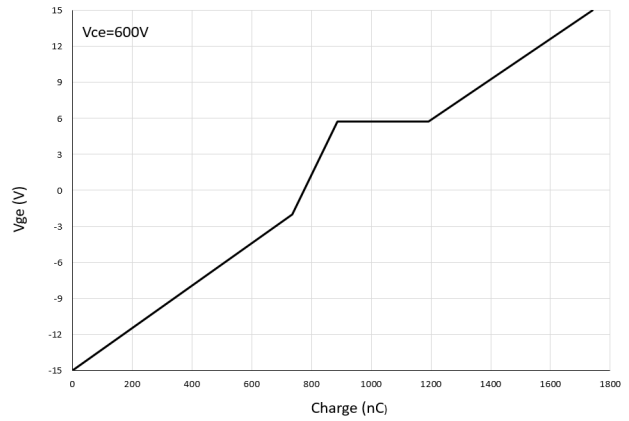

Figure 18. Path IGBT Gate Voltage vs. Gate Charge

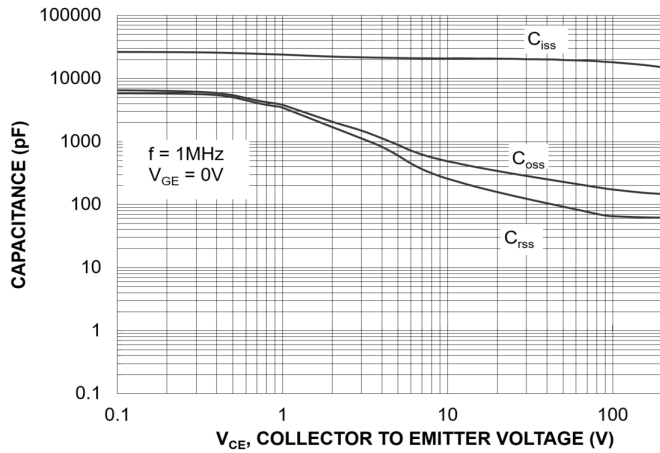

Figure 19. Path IGBT Capacitance

TYPICAL CHARACTERISTICS – BOOST DIODE

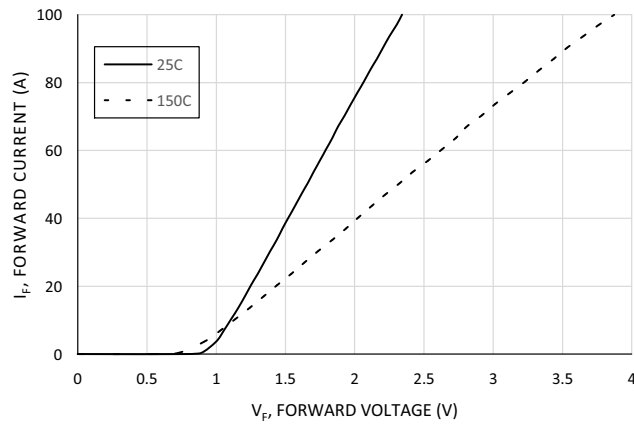

Figure 20. Typical Forward Characteristics

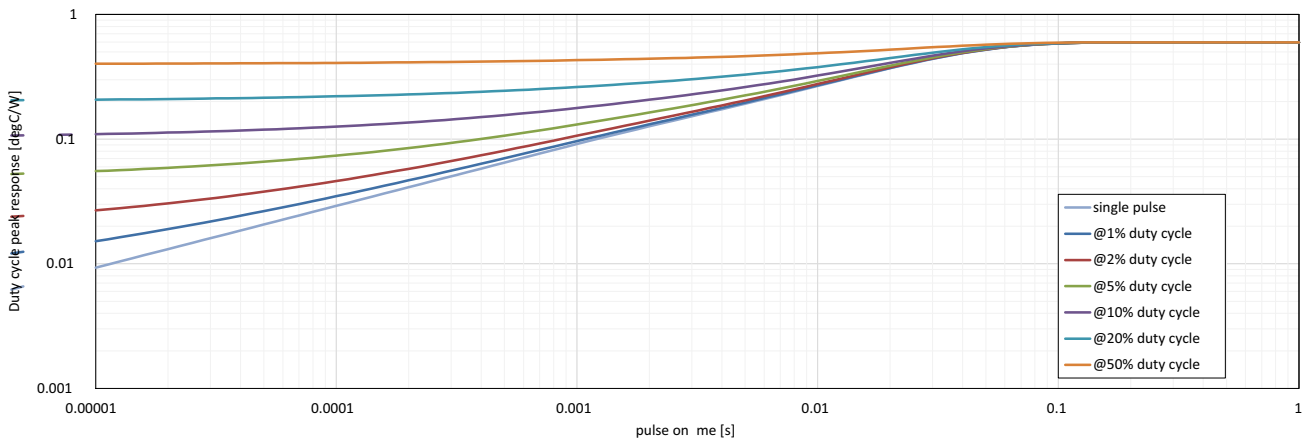

Figure 21. Junction-to-Case Transient Thermal Impedance

NXH200B100H4F2SG, NXH200B100H4F2SG-R

TYPICAL CHARACTERISTICS – BOOST IGBT COMMUTATE BOOST DIODE

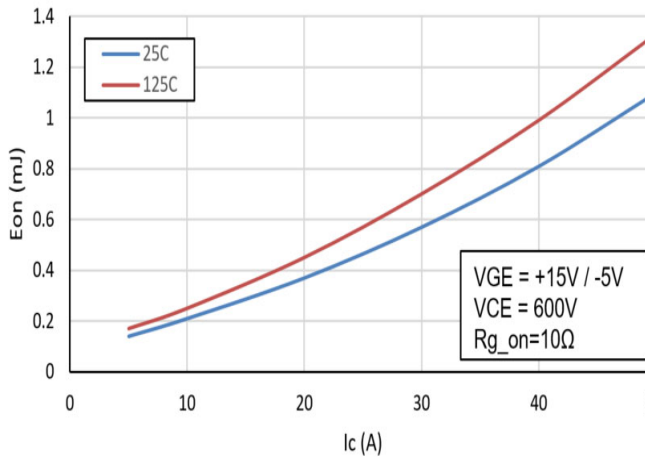

Figure 22. Typical Turn On Loss vs. I_c

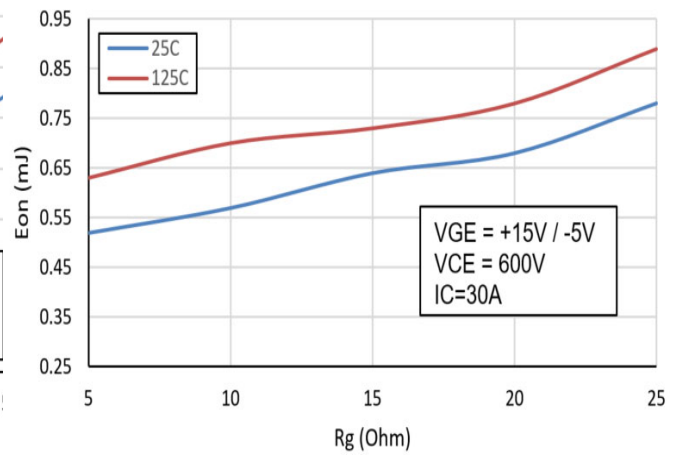

Figure 23. Typical Turn On Loss vs. R_g

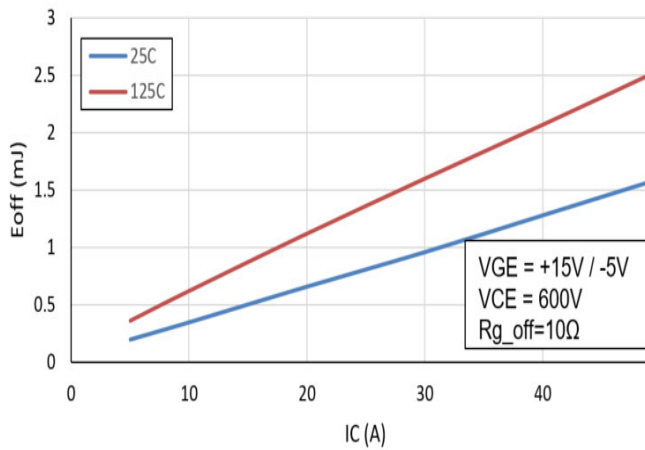

Figure 24. Typical Turn Off Loss vs. I_c

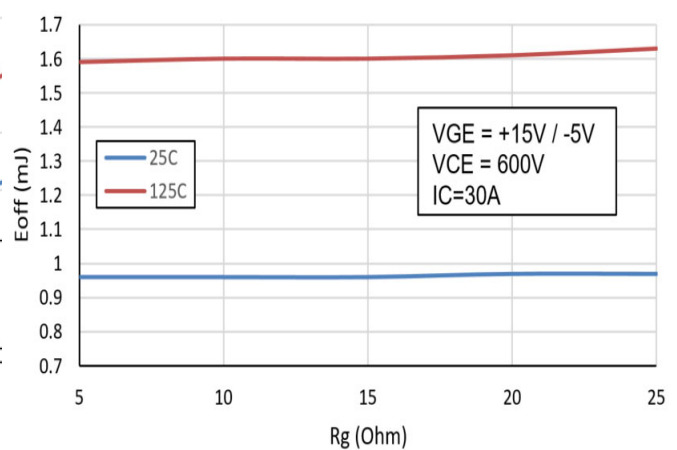

Figure 25. Typical Turn Off Loss vs. R_g

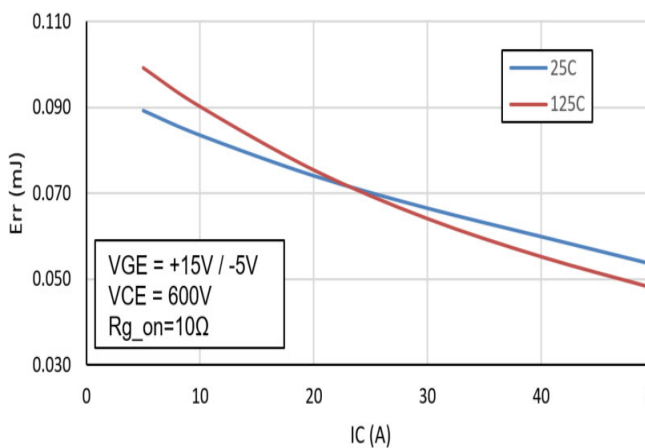

Figure 26. Typical Reverse Recovery Loss vs. I_c

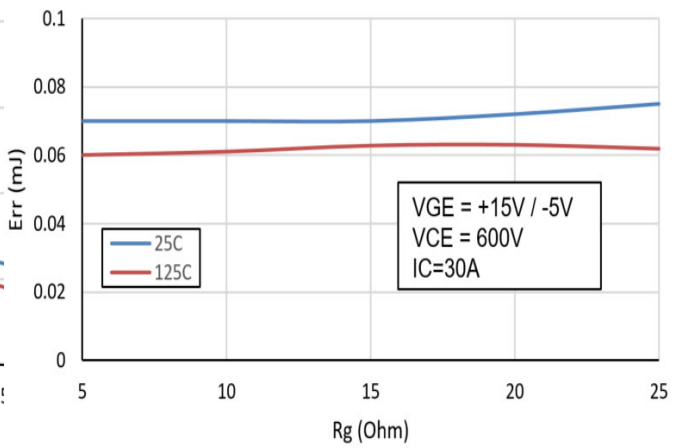

Figure 27. Typical Reverse Recovery Loss vs. R_g

NXH200B100H4F2SG, NXH200B100H4F2SG-R

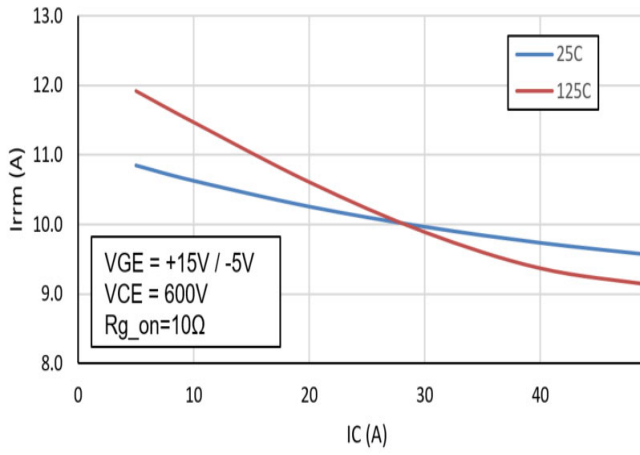

Figure 28. Typical Reverse Recovery Current vs. I_C

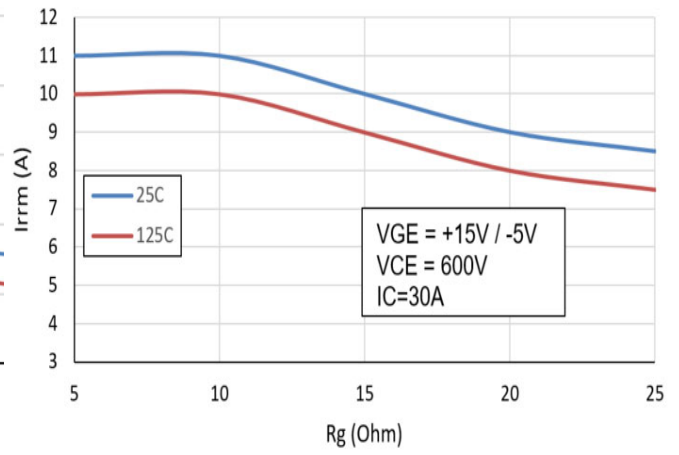

Figure 29. Typical Reverse Recovery Current vs. R_G

TYPICAL CHARACTERISTICS – THERMISTOR

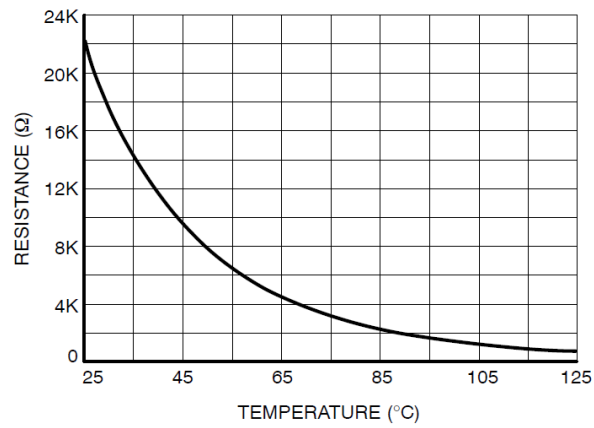
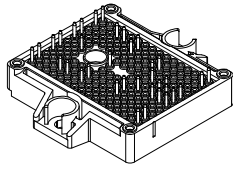

Figure 30. Thermistor Characteristics

MECHANICAL CASE OUTLINE

PACKAGE DIMENSIONS



PIM36 56.7x42.5 (SOLDER PIN)
CASE 180CJ
ISSUE C

DATE 18 MAY 2023

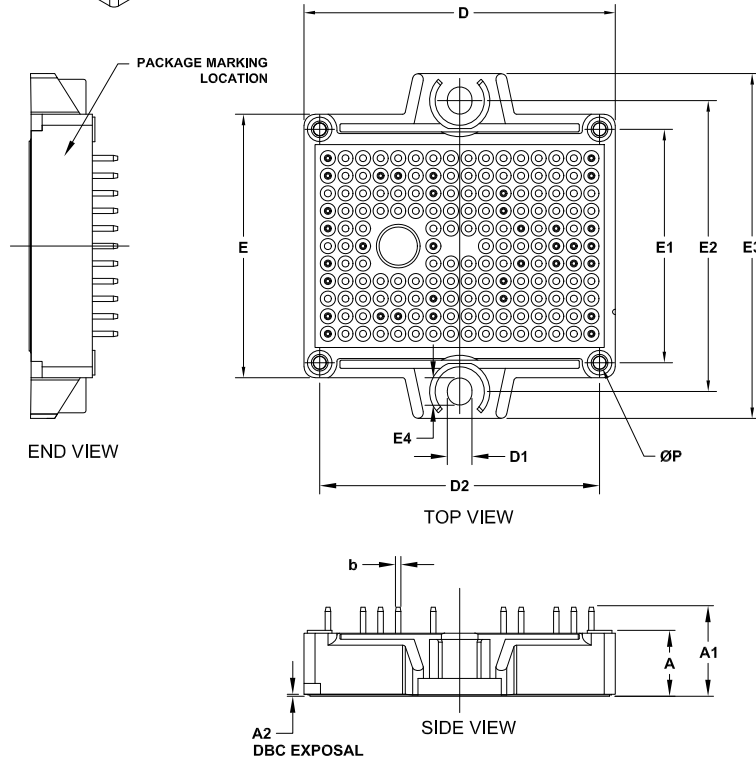

NOTES:

1. CONTROLLING DIMENSION: MILLIMETERS
2. PIN POSITION TOLERANCE IS $\pm 0.4\text{mm}$

DIM	MILLIMETERS		
	MIN.	NOM.	MAX.
A	11.65	12.00	12.35
A1	15.65	16.15	16.65
A2	0.00	0.35	0.60
b	0.95	1.00	1.05
D	56.40	56.70	57.00
D1	4.40	4.50	4.60
D2	50.85	51.00	51.15
E	47.70	48.00	48.30
E1	42.35	42.50	42.65
E2	52.90	53.00	53.10
E3	62.30	62.80	63.30
E4	4.90	5.00	5.10
P	2.20	2.30	2.40

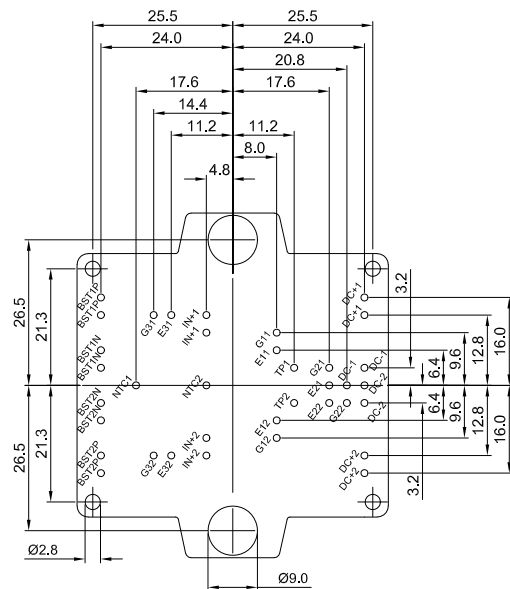

RECOMMENDED MOUNTING PATTERN

* For additional information on our Pb-Free strategy and soldering details, please download the ON Semiconductor Soldering and Mounting Techniques Reference Manual, SOLDER RM/D.

GENERIC MARKING DIAGRAM*

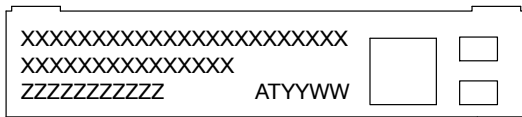

FRONTSIDE MARKING

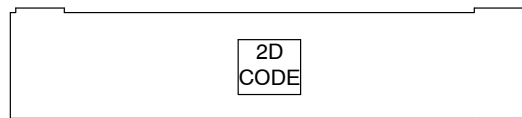

BACKSIDE MARKING

XXXXX = Specific Device Code
 ZZZZ = Assembly Lot Code
 AT = Assembly & Test Site Code
 YYWW = Year and Work Week Code

*This information is generic. Please refer to device data sheet for actual part marking. Pb-Free indicator, "G" or microdot "•", may or may not be present. Some products may not follow the Generic Marking.

DOCUMENT NUMBER:	98AON22702H	Electronic versions are uncontrolled except when accessed directly from the Document Repository. Printed versions are uncontrolled except when stamped "CONTROLLED COPY" in red.
DESCRIPTION:	PIM36 56.7x42.5 (SOLDER PIN)	PAGE 1 OF 1

onsemi and ONSEMI are trademarks of Semiconductor Components Industries, LLC dba onsemi or its subsidiaries in the United States and/or other countries. onsemi reserves the right to make changes without further notice to any products herein. onsemi makes no warranty, representation or guarantee regarding the suitability of its products for any particular purpose, nor does onsemi assume any liability arising out of the application or use of any product or circuit, and specifically disclaims any and all liability, including without limitation special, consequential or incidental damages. onsemi does not convey any license under its patent rights nor the rights of others.

onsemi, **Onsemi**, and other names, marks, and brands are registered and/or common law trademarks of Semiconductor Components Industries, LLC dba "**onsemi**" or its affiliates and/or subsidiaries in the United States and/or other countries. **onsemi** owns the rights to a number of patents, trademarks, copyrights, trade secrets, and other intellectual property. A listing of **onsemi**'s product/patent coverage may be accessed at www.onsemi.com/site/pdf/Patent-Marking.pdf. **onsemi** reserves the right to make changes at any time to any products or information herein, without notice. The information herein is provided "as-is" and **onsemi** makes no warranty, representation or guarantee regarding the accuracy of the information, product features, availability, functionality, or suitability of its products for any particular purpose, nor does **onsemi** assume any liability arising out of the application or use of any product or circuit, and specifically disclaims any and all liability, including without limitation special, consequential or incidental damages. Buyer is responsible for its products and applications using **onsemi** products, including compliance with all laws, regulations and safety requirements or standards, regardless of any support or applications information provided by **onsemi**. "Typical" parameters which may be provided in **onsemi** data sheets and/or specifications can and do vary in different applications and actual performance may vary over time. All operating parameters, including "Typicals" must be validated for each customer application by customer's technical experts. **onsemi** does not convey any license under any of its intellectual property rights nor the rights of others. **onsemi** products are not designed, intended, or authorized for use as a critical component in life support systems or any FDA Class 3 medical devices or medical devices with a same or similar classification in a foreign jurisdiction or any devices intended for implantation in the human body. Should Buyer purchase or use **onsemi** products for any such unintended or unauthorized application, Buyer shall indemnify and hold **onsemi** and its officers, employees, subsidiaries, affiliates, and distributors harmless against all claims, costs, damages, and expenses, and reasonable attorney fees arising out of, directly or indirectly, any claim of personal injury or death associated with such unintended or unauthorized use, even if such claim alleges that **onsemi** was negligent regarding the design or manufacture of the part. **onsemi** is an Equal Opportunity/Affirmative Action Employer. This literature is subject to all applicable copyright laws and is not for resale in any manner.

ADDITIONAL INFORMATION

TECHNICAL PUBLICATIONS:

Technical Library: www.onsemi.com/design/resources/technical-documentation
onsemi Website: www.onsemi.com

ONLINE SUPPORT: www.onsemi.com/support

For additional information, please contact your local Sales Representative at www.onsemi.com/support/sales