

MOSFET - Power, Single P-Channel, SO8-FL

-30 V, 1.8 mΩ, -234 A

NVMFS003P03P8Z

Features

- Ultra Low $R_{DS(on)}$ to Improve System Efficiency
- Advanced Package Technology in 5x6mm for Space Saving and Excellent Thermal Conduction
- These Devices are Pb-Free, Halogen Free/BFR Free and are RoHS Compliant

Typical Applications

- Power Load Switch
- Protection: Reverse Current, Over Voltage, and Reverse Negative Voltage
- Battery Management

MAXIMUM RATINGS ($T_J = 25^\circ\text{C}$ unless otherwise noted)

Parameter		Symbol	Value	Unit	
Drain-to-Source Voltage		V_{DSS}	-30	V	
Gate-to-Source Voltage		V_{GS}	± 25	V	
Continuous Drain Current $R_{\theta JC}$ (Note 2)	Steady State	$T_C = 25^\circ\text{C}$	I_D	-234	A
		$T_C = 100^\circ\text{C}$		-169	
Power Dissipation $R_{\theta JC}$ (Note 2)		$T_C = 25^\circ\text{C}$	P_D	168.7	W
		$T_C = 100^\circ\text{C}$		84.4	
Continuous Drain Current $R_{\theta JA}$ (Notes 1, 2)	Steady State	$T_A = 25^\circ\text{C}$	I_D	-35.7	A
		$T_A = 100^\circ\text{C}$		-25.7	
Power Dissipation $R_{\theta JA}$ (Notes 1, 2)		$T_A = 25^\circ\text{C}$	P_D	3.9	W
		$T_A = 100^\circ\text{C}$		1.9	
Pulsed Drain Current	$T_A = 25^\circ\text{C}, t_p = 10 \mu\text{s}$	I_{DM}	-900	A	
Single Pulse Drain-to-Source Avalanche Energy ($I_{Lpk} = 37.1 \text{ A}$)		E_{AS}	186	mJ	
Operating Junction and Storage Temperature Range		T_J, T_{stg}	-55 to +175	$^\circ\text{C}$	
Lead Temperature for Soldering Purposes (1/8" from case for 10 s)		T_L	260	$^\circ\text{C}$	

Stresses exceeding those listed in the Maximum Ratings table may damage the device. If any of these limits are exceeded, device functionality should not be assumed, damage may occur and reliability may be affected.

1. Surface-mounted on FR4 board using a 1 in² pad size, 2 oz. Cu pad.
2. The entire application environment impacts the thermal resistance values shown, they are not constants and are only valid for the particular conditions noted.

$V_{(BR)DSS}$	$R_{DS(on)}$	I_D
-30 V	1.8 mΩ @ -10 V	-234 A
	2.9 mΩ @ -4.5 V	

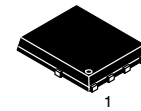
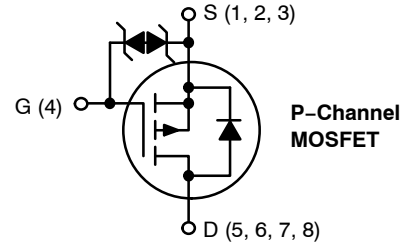

DFN5 5x6, 1.27P (SO-8FL)
CASE 488AA

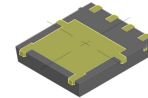

DFNW5 5x6 (FULL-CUT SO8FL WF)
CASE 507BA

MARKING DIAGRAM

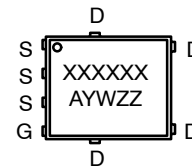

- A = Assembly Location
- Y = Year
- W = Work Week
- ZZ = Lot Traceability

ORDERING INFORMATION

See detailed ordering and shipping information on page 6 of this data sheet.

NVMFS003P03P8Z

THERMAL RESISTANCE MAXIMUM RATINGS

Parameter	Symbol	Value	Unit
Junction-to-Case – Steady State (Drain) (Note 1)	$R_{\theta JC}$	0.9	$^{\circ}C/W$
Junction-to-Ambient – Steady State (Note 1)	$R_{\theta JA}$	39	$^{\circ}C/W$

ELECTRICAL CHARACTERISTICS ($T_J = 25^{\circ}C$ unless otherwise noted)

Parameter	Symbol	Test Condition	Min	Typ	Max	Unit
-----------	--------	----------------	-----	-----	-----	------

OFF CHARACTERISTICS

Drain-to-Source Breakdown Voltage	$V_{(BR)DSS}$	$V_{GS} = 0 V, I_D = -250 \mu A$	-30			V
Drain-to-Source Breakdown Voltage Temperature Coefficient	$V_{(BR)DSS}/T_J$	$I_D = -250 \mu A, \text{ref to } 25^{\circ}C$		-5		$mV/^{\circ}C$
Zero Gate Voltage Drain Current	I_{DSS}	$V_{GS} = 0 V, V_{DS} = -30 V, T_J = 25^{\circ}C$			-10	μA
Gate-to-Source Leakage Current	I_{GSS}	$V_{DS} = 0 V, V_{GS} = \pm 25 V$			± 10	μA

ON CHARACTERISTICS (Note 3)

Gate Threshold Voltage	$V_{GS(TH)}$	$V_{GS} = V_{DS}, I_D = -250 \mu A$	-1.0		-3.0	V
Threshold Temperature Coefficient	$V_{GS(TH)}/T_J$	$I_D = -250 \mu A, \text{ref to } 25^{\circ}C$		5.5		$mV/^{\circ}C$
Drain-to-Source On Resistance	$R_{DS(on)}$	$V_{GS} = -10 V, I_D = -23 A$		1.2	1.8	$m\Omega$
		$V_{GS} = -4.5 V, I_D = -20 A$		1.9	2.9	
Forward Transconductance	g_{FS}	$V_{DS} = -5 V, I_D = -20 A$		110		S

CHARGES AND CAPACITANCES

Input Capacitance	C_{iss}	$V_{GS} = 0 V, V_{DS} = -15 V, f = 1.0 \text{ MHz}$		12120		pF
Output Capacitance	C_{oss}			4020		
Reverse Transfer Capacitance	C_{rss}			4100		
Total Gate Charge	$Q_{G(TOT)}$	$V_{GS} = -4.5 V, V_{DS} = -15 V, I_D = -23 A$		167		nC
Threshold Gate Charge	$Q_{G(TH)}$			7		
Gate-to-Source Charge	Q_{GS}			21		
Gate-to-Drain Charge	Q_{GD}			116		
Total Gate Charge	$Q_{G(TOT)}$	$V_{GS} = -10 V, V_{DS} = -15 V, I_D = -23 A$		277		

SWITCHING CHARACTERISTICS, $V_{GS} = 4.5 V$ (Note 3)

Turn-On Delay Time	$t_{d(on)}$	$V_{GS} = -4.5 V, V_{DS} = -15 V, I_D = -23 A, R_G = 6 \Omega$		81		ns
Rise Time	t_r			440		
Turn-Off Delay Time	$t_{d(off)}$			180		
Fall Time	t_f			400		

SWITCHING CHARACTERISTICS, $V_{GS} = 10 V$ (Note 3)

Turn-On Delay Time	$t_{d(on)}$	$V_{GS} = -10 V, V_{DS} = -15 V, I_D = -23 A, R_G = 6 \Omega$		28		ns
Rise Time	t_r			116		
Turn-Off Delay Time	$t_{d(off)}$			325		
Fall Time	t_f			380		

DRAIN-SOURCE DIODE CHARACTERISTICS

Forward Diode Voltage	V_{SD}	$V_{GS} = 0 V, I_S = -23 A$	$T_J = 25^{\circ}C$	-0.75	-1.3	V
			$T_J = 125^{\circ}C$	-0.6		

NVMFS003P03P8Z

ELECTRICAL CHARACTERISTICS (T_J = 25°C unless otherwise noted)

Parameter	Symbol	Test Condition	Min	Typ	Max	Unit
DRAIN-SOURCE DIODE CHARACTERISTICS						
Reverse Recovery Time	t _{RR}	V _{GS} = 0 V, di _s /dt = 100 A/μs, I _s = -23 A		70		ns
Charge Time	t _a			43		
Discharge Time	t _b			28		
Reverse Recovery Charge	Q _{RR}			116		nC

Product parametric performance is indicated in the Electrical Characteristics for the listed test conditions, unless otherwise noted. Product performance may not be indicated by the Electrical Characteristics if operated under different conditions.

3. Pulse Test: Pulse Width ≤ 300 μs, Duty Cycle ≤ 2%.

TYPICAL CHARACTERISTICS

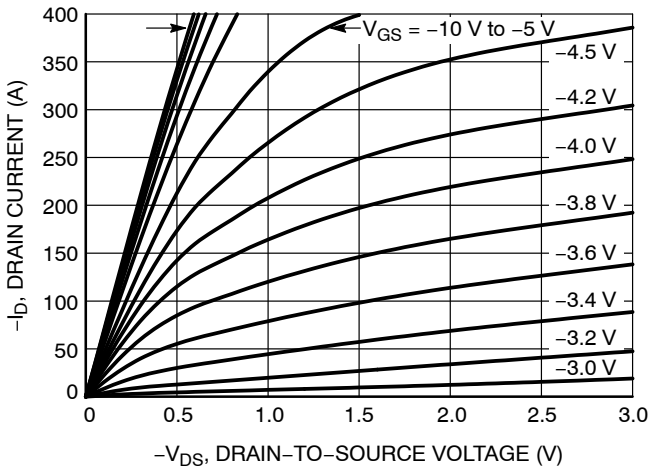

Figure 1. On-Region Characteristics

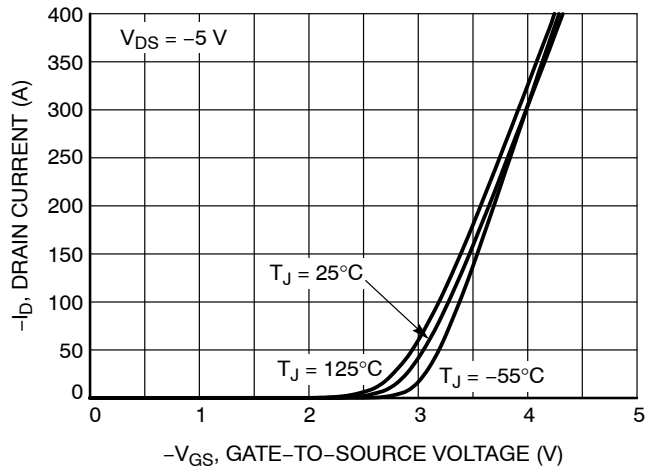

Figure 2. Transfer Characteristics

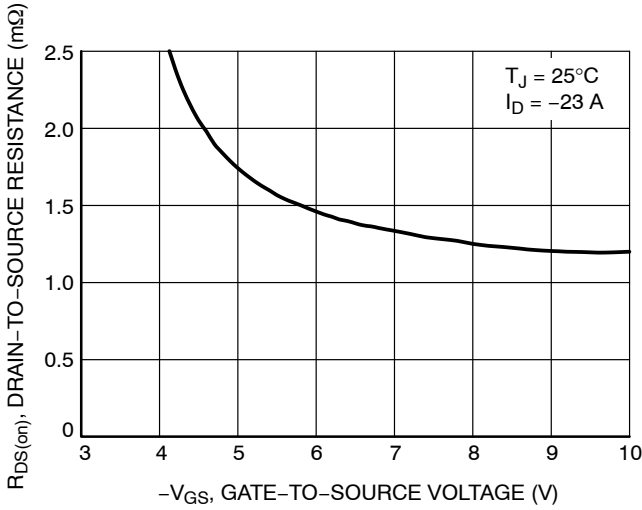

Figure 3. On-Resistance vs. Gate-to-Source Voltage

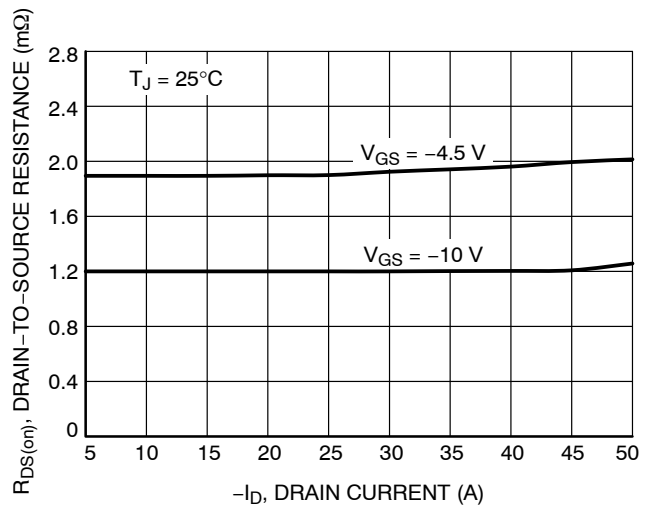

Figure 4. On-Resistance vs. Drain Current and Gate Voltage

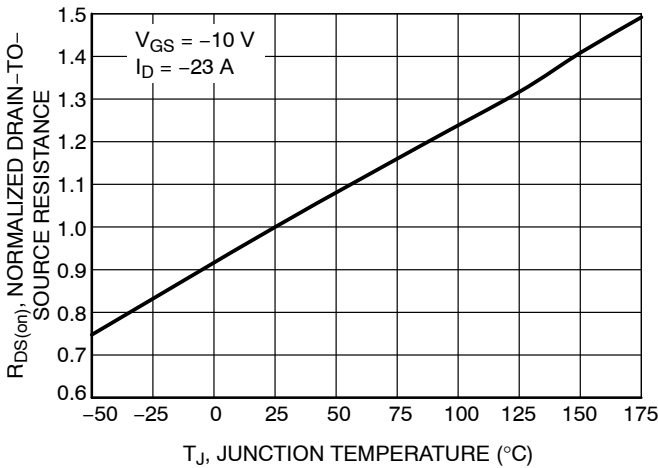

Figure 5. On-Resistance Variation with Temperature

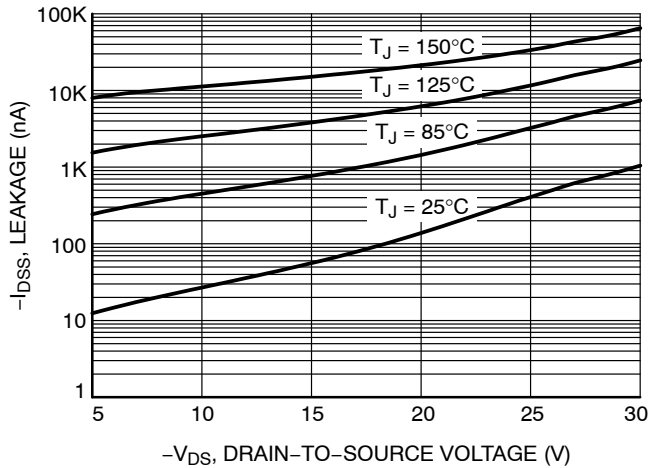

Figure 6. Drain-to-Source Leakage Current vs. Voltage

TYPICAL CHARACTERISTICS

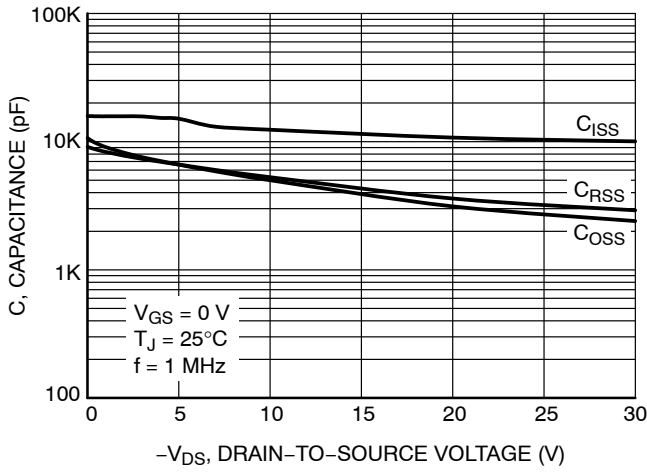

Figure 7. Capacitance Variation

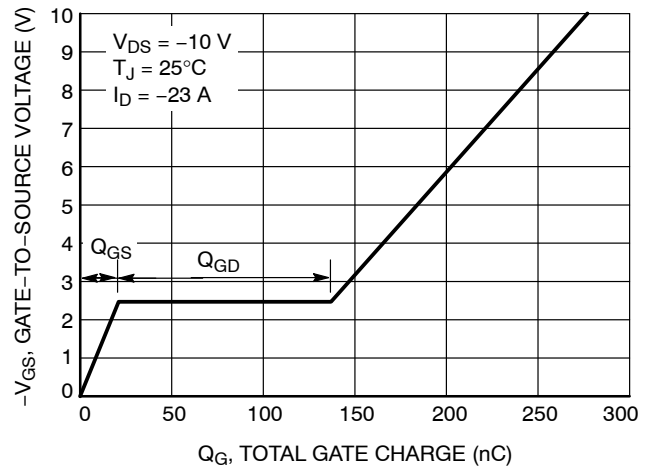

Figure 8. Gate-to-Source Voltage vs. Total Charge

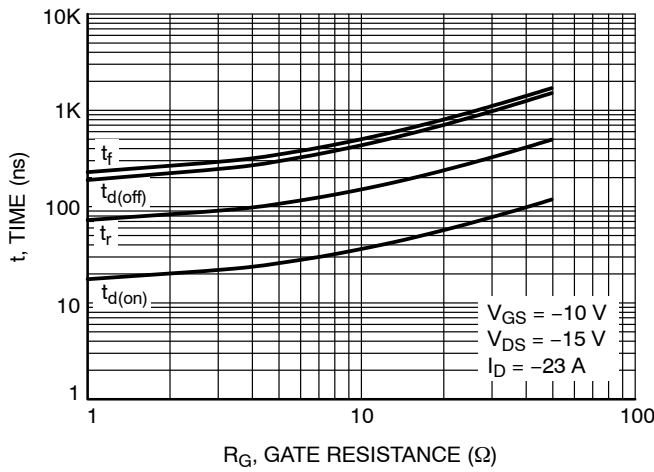

Figure 9. Resistive Switching Time Variation vs. Gate Resistance

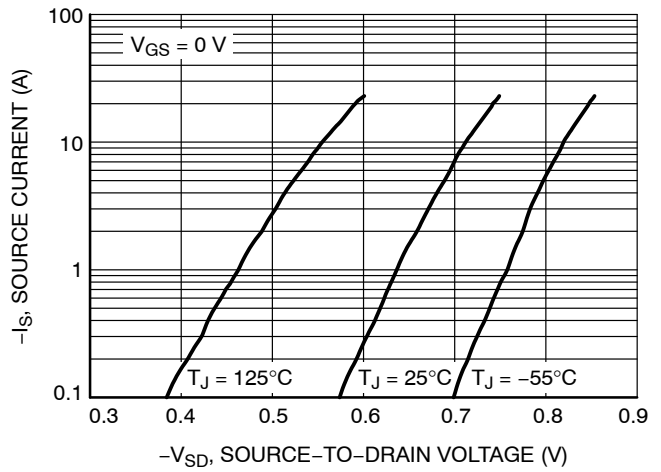

Figure 10. Diode Forward Voltage vs. Current

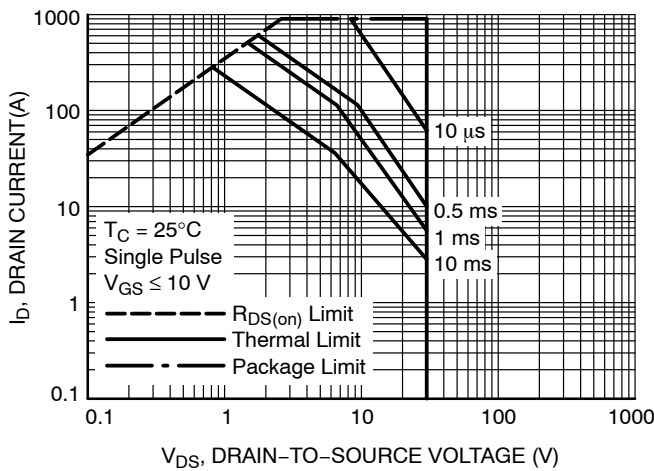

Figure 11. Maximum Rated Forward Biased Safe Operating Area

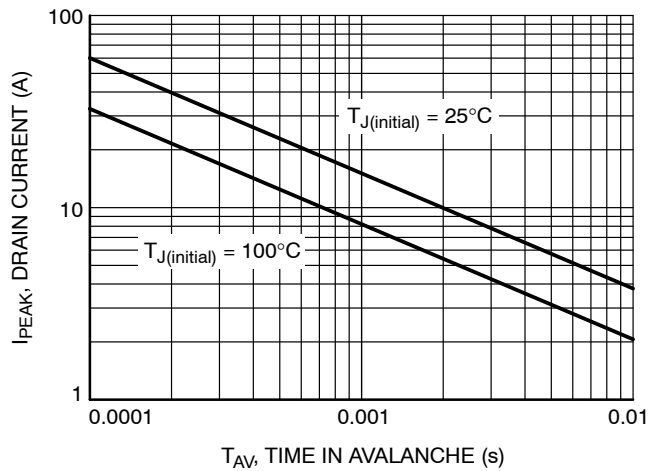

Figure 12. I_{PEAK} vs. Time in Avalanche

NVMFS003P03P8Z

TYPICAL CHARACTERISTICS

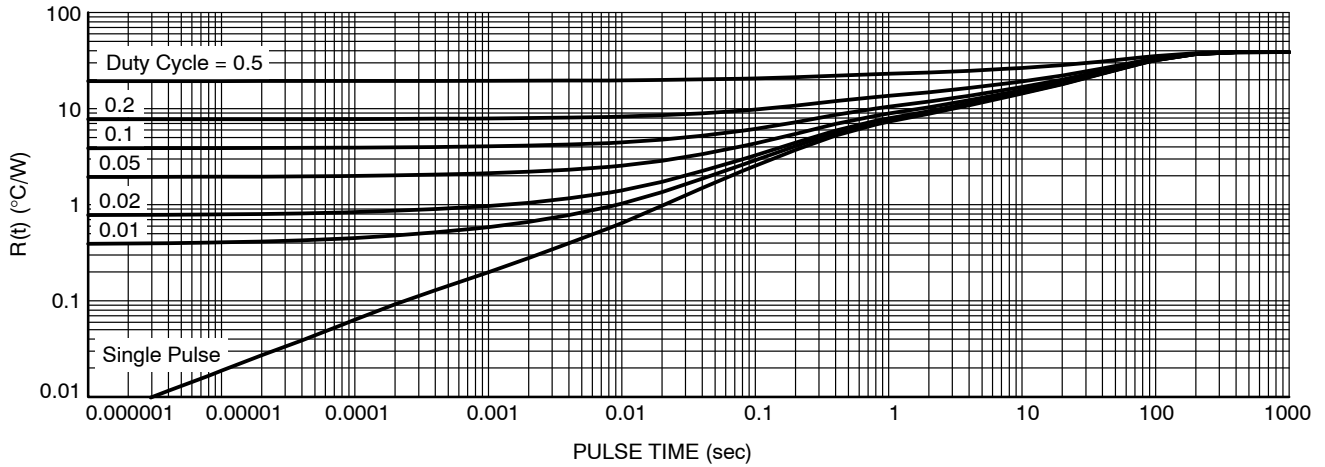

Figure 13. Thermal Characteristics

PACKAGE MARKING AND ORDERING INFORMATION

Part Number	Top Marking	Package	Shipping [†]
NVMFS003P03P8ZT1G	03P3	DFN5 5x6, 1.27P (Pb-Free)	1500 / Tape & Reel
NVMFWS003P03P8ZT1G	03P3W	DFNW5, 5x6 (FULL-CUT SO8FL WF) (Pb-Free, Wettable Flanks)	1500 / Tape & Reel

[†]For information on tape and reel specifications, including part orientation and tape sizes, please refer to our Tape and Reel Packaging Specifications Brochure, BRD8011/D.

MECHANICAL CASE OUTLINE

PACKAGE DIMENSIONS



1
SCALE 2:1

DFN5 5x6, 1.27P
(SO-8FL)
CASE 488AA
ISSUE N

DATE 25 JUN 2018

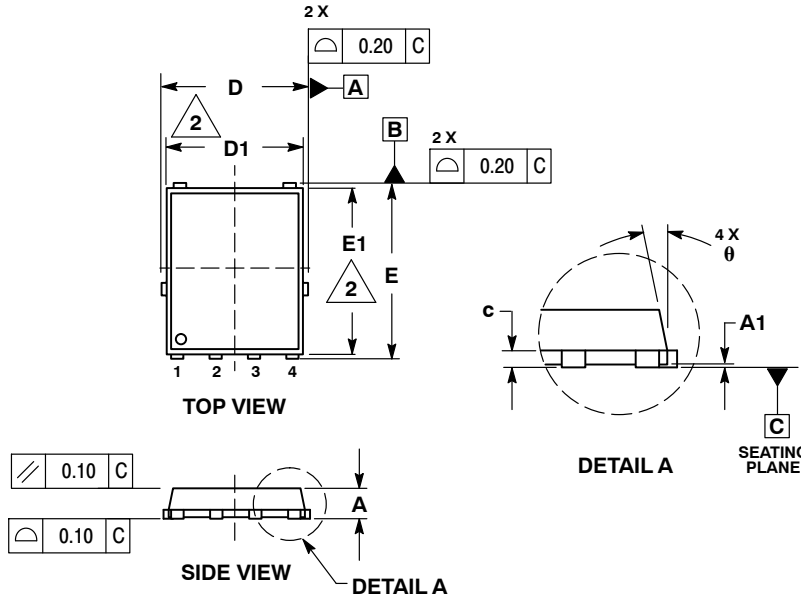

NOTES:

1. DIMENSIONING AND TOLERANCING PER ASME Y14.5M, 1994.
2. CONTROLLING DIMENSION: MILLIMETER.
3. DIMENSION D1 AND E1 DO NOT INCLUDE MOLD FLASH PROTRUSIONS OR GATE BURRS.

DIM	MILLIMETERS		
	MIN	NOM	MAX
A	0.90	1.00	1.10
A1	0.00	---	0.05
b	0.33	0.41	0.51
c	0.23	0.28	0.33
D	5.00	5.15	5.30
D1	4.70	4.90	5.10
D2	3.80	4.00	4.20
E	6.00	6.15	6.30
E1	5.70	5.90	6.10
E2	3.45	3.65	3.85
e	1.27 BSC		
G	0.51	0.575	0.71
K	1.20	1.35	1.50
L	0.51	0.575	0.71
L1	0.125 REF		
M	3.00	3.40	3.80
θ	0°	---	12°

GENERIC MARKING DIAGRAM*



- XXXXXX = Specific Device Code
- A = Assembly Location
- Y = Year
- W = Work Week
- ZZ = Lot Traceability

*This information is generic. Please refer to device data sheet for actual part marking. Pb-Free indicator, "G" or microdot "•", may or may not be present. Some products may not follow the Generic Marking.



- STYLE 1:
PIN 1. SOURCE
2. SOURCE
3. SOURCE
4. GATE
5. DRAIN
- STYLE 2:
PIN 1. ANODE
2. ANODE
3. ANODE
4. NO CONNECT
5. CATHODE

DIMENSIONS: MILLIMETERS

*For additional information on our Pb-Free strategy and soldering details, please download the ON Semiconductor Soldering and Mounting Techniques Reference Manual, SOLDERRM/D.

DOCUMENT NUMBER:	98AON14036D	Electronic versions are uncontrolled except when accessed directly from the Document Repository. Printed versions are uncontrolled except when stamped "CONTROLLED COPY" in red.
DESCRIPTION:	DFN5 5x6, 1.27P (SO-8FL)	PAGE 1 OF 1

onsemi and ONSEMI are trademarks of Semiconductor Components Industries, LLC dba onsemi or its subsidiaries in the United States and/or other countries. onsemi reserves the right to make changes without further notice to any products herein. onsemi makes no warranty, representation or guarantee regarding the suitability of its products for any particular purpose, nor does onsemi assume any liability arising out of the application or use of any product or circuit, and specifically disclaims any and all liability, including without limitation special, consequential or incidental damages. onsemi does not convey any license under its patent rights nor the rights of others.

MECHANICAL CASE OUTLINE

PACKAGE DIMENSIONS

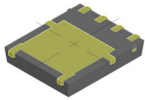

DFNW5 5x6 (FULL-CUT SO8FL WF)

CASE 507BA

ISSUE A

DATE 03 FEB 2021

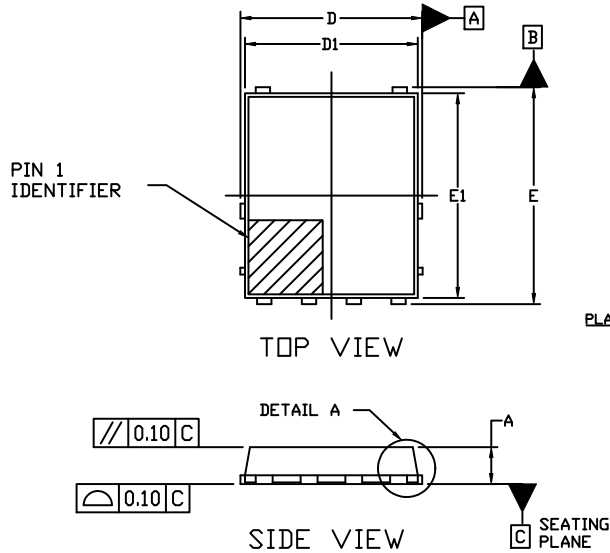

NOTES:

1. DIMENSIONING AND TOLERANCING PER ASME Y14.5M, 2009.
2. CONTROLLING DIMENSION: MILLIMETERS
3. DIMENSIONS D1 AND E1 DO NOT INCLUDE MOLD FLASH, PROTRUSIONS, OR GATE BURRS.
4. THIS PACKAGE CONTAINS WETTABLE FLANK DESIGN FEATURES TO AID IN FILLET FORMATION ON THE LEADS DURING MOUNTING.

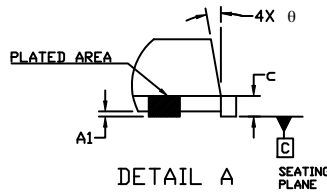

DIM	MILLIMETERS		
	MIN.	NOM.	MAX.
A	0.90	1.00	1.10
A1	0.00	---	0.05
b	0.33	0.41	0.51
c	0.23	0.28	0.33
D	5.00	5.15	5.30
D1	4.70	4.90	5.10
E	6.00	6.15	6.30
E1	5.70	5.90	6.10
E2	3.45	3.65	3.85
e	1.27 BSC		
G	0.51	0.575	0.71
K	1.20	1.35	1.50
L	0.51	0.575	0.71
L1	0.150 REF		
M	3.00	3.40	3.80
θ	0°	---	12°

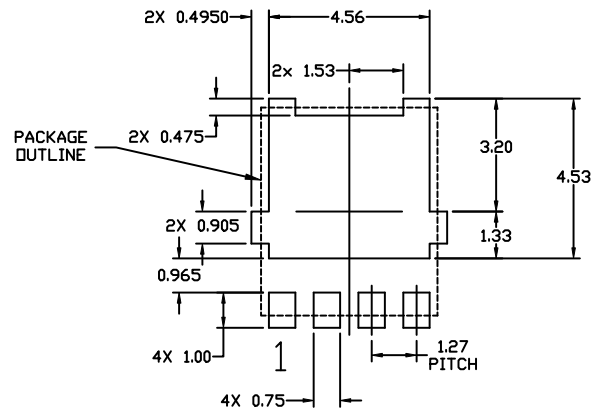
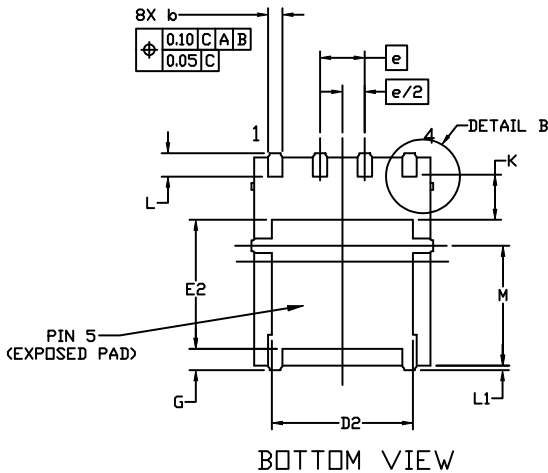
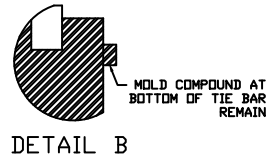

GENERIC MARKING DIAGRAM*

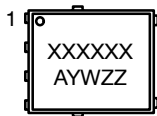

- XXXXXX = Specific Device Code
 A = Assembly Location
 Y = Year
 W = Work Week
 ZZ = Lot Traceability
- *This information is generic. Please refer to device data sheet for actual part marking. Pb-Free indicator, "G" or microdot "•", may or may not be present. Some products may not follow the Generic Marking.

RECOMMENDED MOUNTING FOOTPRINT

* For additional information on our Pb-Free strategy and soldering details, please download the ON Semiconductor Soldering and Mounting Techniques Reference Manual, SOLDERRM/D.

DOCUMENT NUMBER:	98AON26450H	Electronic versions are uncontrolled except when accessed directly from the Document Repository. Printed versions are uncontrolled except when stamped "CONTROLLED COPY" in red.
DESCRIPTION:	DFNW5 5x6 (FULL-CUT SO8FL WF)	PAGE 1 OF 1

onsemi and ONSEMI are trademarks of Semiconductor Components Industries, LLC dba onsemi or its subsidiaries in the United States and/or other countries. onsemi reserves the right to make changes without further notice to any products herein. onsemi makes no warranty, representation or guarantee regarding the suitability of its products for any particular purpose, nor does onsemi assume any liability arising out of the application or use of any product or circuit, and specifically disclaims any and all liability, including without limitation special, consequential or incidental damages. onsemi does not convey any license under its patent rights nor the rights of others.

onsemi, **Onsemi**, and other names, marks, and brands are registered and/or common law trademarks of Semiconductor Components Industries, LLC dba "**onsemi**" or its affiliates and/or subsidiaries in the United States and/or other countries. **onsemi** owns the rights to a number of patents, trademarks, copyrights, trade secrets, and other intellectual property. A listing of **onsemi**'s product/patent coverage may be accessed at www.onsemi.com/site/pdf/Patent-Marking.pdf. **onsemi** reserves the right to make changes at any time to any products or information herein, without notice. The information herein is provided "as-is" and **onsemi** makes no warranty, representation or guarantee regarding the accuracy of the information, product features, availability, functionality, or suitability of its products for any particular purpose, nor does **onsemi** assume any liability arising out of the application or use of any product or circuit, and specifically disclaims any and all liability, including without limitation special, consequential or incidental damages. Buyer is responsible for its products and applications using **onsemi** products, including compliance with all laws, regulations and safety requirements or standards, regardless of any support or applications information provided by **onsemi**. "Typical" parameters which may be provided in **onsemi** data sheets and/or specifications can and do vary in different applications and actual performance may vary over time. All operating parameters, including "Typicals" must be validated for each customer application by customer's technical experts. **onsemi** does not convey any license under any of its intellectual property rights nor the rights of others. **onsemi** products are not designed, intended, or authorized for use as a critical component in life support systems or any FDA Class 3 medical devices or medical devices with a same or similar classification in a foreign jurisdiction or any devices intended for implantation in the human body. Should Buyer purchase or use **onsemi** products for any such unintended or unauthorized application, Buyer shall indemnify and hold **onsemi** and its officers, employees, subsidiaries, affiliates, and distributors harmless against all claims, costs, damages, and expenses, and reasonable attorney fees arising out of, directly or indirectly, any claim of personal injury or death associated with such unintended or unauthorized use, even if such claim alleges that **onsemi** was negligent regarding the design or manufacture of the part. **onsemi** is an Equal Opportunity/Affirmative Action Employer. This literature is subject to all applicable copyright laws and is not for resale in any manner.

ADDITIONAL INFORMATION

TECHNICAL PUBLICATIONS:

Technical Library: www.onsemi.com/design/resources/technical-documentation
onsemi Website: www.onsemi.com

ONLINE SUPPORT: www.onsemi.com/support

For additional information, please contact your local Sales Representative at www.onsemi.com/support/sales