

Automotive 750 V, 800 A Dual Side Cooling Half-Bridge Power Module

VE-Trac™ Dual Gen II NVG800A75L4DSB2

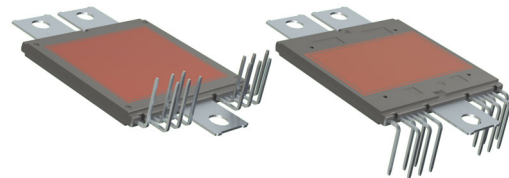

AHPM15-CEC
 CASE MODHV

Product Description

The NVG800A75L4DSB2 is part of a family of power modules with dual side cooling and compact footprints for Hybrid (HEV) and Electric Vehicle (EV) traction inverter application.

The module consists of two narrow mesa Field Stop (FS4) IGBTs in a half-bridge configuration. The chipset utilizes the new narrow mesa IGBT technology in providing high current density and robust short circuit protection with higher blocking voltage to deliver outstanding performance in EV traction applications.

Liquid cooling heatsink reference design, loss models and CAD models are available to support customers in inverter designs.

Features

- Dual-Side Cooling
- Integrated Chip Level Temperature and Current Sensor
- $T_{vj\ max} = 175^{\circ}C$ for Continuous Operation
- Low-stray Inductance
- Low Conduction and Switching Losses
- Automotive Grade
- 4.2 kV Isolated DBC Substrate
- AEC Qualified and PPAP Capable
- This Device is Pb-Free and is RoHS Compliant

Typical Applications

- Hybrid and Electric Vehicle Traction Inverter
- High Power DC-DC Converter

MARKING DIAGRAM

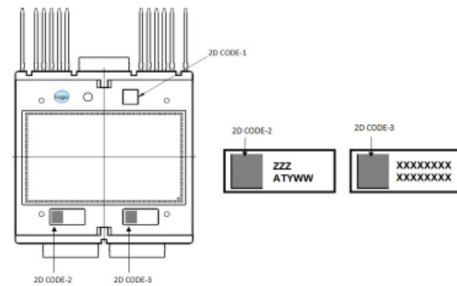

ZZZ = Assembly Lot Code
 AT = Assembly & Test Location
 Y = Year
 WW = Work Week
 XXXX = Specific Device Code

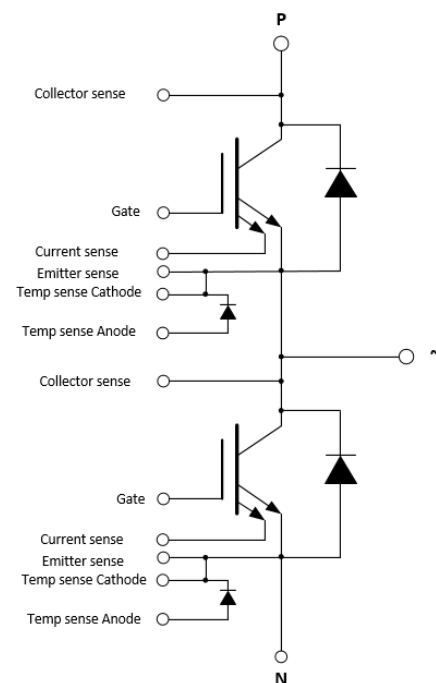

ORDERING INFORMATION

See detailed ordering and shipping information on page 5 of this data sheet.

VE-Trac™ Dual Gen II NVG800A75L4DSB2

PIN DESCRIPTION

Pin #	Pin	Pin Function Description	Pin Arrangement
1	N	Low Side Emitter	
2	P	High Side Collector	
3	H/S COLLECTOR SENSE	High Side Collector Sense	
4	H/S CURRENT SENSE	High Side Current Sense	
5	H/S EMITTER SENSE	High Side Emitter Sense	
6	H/S GATE	High Side Gate	
7	H/S TEMP SENSE (CATHODE)	High Side Temp sense Diode Cathode	
8	H/S TEMP SENSE (ANODE)	High Side Temp sense Diode Anode	
9	~	Phase Output	
10	L/S CURRENT SENSE	Low Side Current Sense	
11	L/S EMITTER SENSE	Low Side Emitter Sense	
12	L/S GATE	Low Side Gate	
13	L/S TEMP SENSE (CATHODE)	Low Side Temp sense Diode Cathode	
14	L/S TEMP SENSE (ANODE)	Low Side Temp sense Diode Anode	
15	L/S COLLECTOR SENSE	Low Side Collector Sense	

Materials

DBC Substrate: Al₂O₃ isolated substrate, basic isolation, and copper on both sides.

Lead Frame

Copper with Tin electro-plating.

Flammability Information

All materials present in the power module meet UL flammability rating class 94V-0.

MODULE CHARACTERISTICS

Symbol	Parameter	Rating	Unit		
T _{vj}	Continuous Operating Junction Temperature Range	-40 to 175	°C		
T _{STG}	Storage Temperature range	-40 to 125	°C		
V _{ISO}	Isolation Voltage, AC, f = 50 Hz, t = 1 s	4200	V		
Creepage	Minimum: Terminal to Terminal	5.0	mm		
Clearance	Minimum: (Note 1) Terminal to Terminal	3.2	mm		
CTI	Comparative Tracking Index	>600			
		Min	Typ	Max	
L _{sCE}	Stray Inductance		8		nH
R _{CC'+EE'}	Module Lead Resistance, Terminals - Chip		0.15		mΩ
G	Module Weight		75		g
M	M4 Screws for Module Terminals			2.2	Nm

1. Verified by design / not by test.

VE-Trac™ Dual Gen II NVG800A75L4DSB2

ABSOLUTE MAXIMUM RATINGS (T_{VJ} = 25°C, Unless Otherwise Specified)

Symbol	Parameter	Rating	Unit
IGBT			
V _{CES}	Collector to Emitter Voltage	750	V
V _{GES}	Gate to Emitter Voltage	±20	V
I _{CN}	Implemented Collector Current	800	A
I _{C nom}	Continuous DC Collector Current, T _{VJmax} = 175°C, T _F = 65°C, ref. heatsink	550 ⁽¹⁾	A
I _{CRM}	Pulsed Collector Current @ V _{GE} = 15 V, t _p = 1 ms	1600	A

DIODE

V _{RRM}	Repetitive peak reverse voltage	750	V
I _{FN}	Implemented Forward Current	800	A
I _F	Continuous Forward Current, T _{VJmax} = 175°C, T _F = 65°C, ref. heatsink	420 ⁽¹⁾	A
I _{FRM}	Repetitive Peak Forward Current, t _p = 1 ms	1600	A
I ² t value	Surge current capability, V _R = 0 V, t _p = 10 ms, T _{VJ} = 150°C T _{VJ} = 175°C	20000 18000	A ² s

Stresses exceeding those listed in the Maximum Ratings table may damage the device. If any of these limits are exceeded, device functionality should not be assumed, damage may occur and reliability may be affected.

2. Verified by characterization, not by test.

THERMAL CHARACTERISTICS (Verified by characterization, not by test.)

Symbol	Parameter	Min	Typ	Max	Unit
IGBT.R _{th,J-C}	Effective Rth, Junction to Case ⁽³⁾		0.05	0.07	°C/W
IGBT.R _{th,J-F}	Effective Rth, Junction to Fluid, λ _{TIM} = 6 W/m-K, F = 660 N 10 L/min, 65°C, 50/50 EGW, Ref. Heatsink		0.128		°C/W
Diode.R _{th,J-C}	Effective Rth, Junction to Case ⁽³⁾		0.07	0.09	°C/W
Diode.R _{th,J-F}	Effective Rth, Junction to Fluid, λ _{TIM} = 6 W/m-K, F = 660 N 10 L/min, 65°C, 50/50 EGW, Ref. Heatsink		0.186		°C/W

3. For the measurement point of case temperature (T_c), DBC discoloration, picker circle print is allowed, please refer to the VE-Trac Dual assembly guide for additional details about acceptable DBC surface finish.

VE-Trac™ Dual Gen II NVG800A75L4DSB2

CHARACTERISTICS OF IGBT (T_{vj} = 25°C, Unless Otherwise Specified)

Parameters		Conditions	Min	Typ	Max	Unit
V _{CESAT}	Collector to Emitter Saturation Voltage (Terminal)	V _{GE} = 15 V, I _C = 600 A, T _{vj} = 25°C T _{vj} = 150°C T _{vj} = 175°C V _{GE} = 15 V, I _C = 800 A, T _{vj} = 25°C T _{vj} = 150°C T _{vj} = 175°C	–	1.30 1.42 1.44 1.43 1.63 1.66	1.69	V
I _{CES}	Collector to Emitter Leakage Current	V _{GE} = 0, V _{CE} = 750 V T _{vj} = 25°C T _{vj} = 175°C	– –	– 8	1 –	mA mA
I _{GES}	Gate – Emitter Leakage Current	V _{CE} = 0, V _{GE} = ± 20 V	–	–	±400	nA
V _{th}	Threshold Voltage	V _{CE} = V _{GE} , I _C = 500 mA	4.5	5.5	6.5	V
Q _G	Total Gate Charge	V _{GE} = –8 to 15 V, V _{CE} = 400 V	–	1.7	–	μC
R _{Gint}	Internal gate resistance		–	2	–	Ω
C _{ies}	Input Capacitance	V _{CE} = 30 V, V _{GE} = 0 V, f = 100 KHz	–	43	–	nF
C _{oes}	Output Capacitance	V _{CE} = 30 V, V _{GE} = 0 V, f = 100 KHz	–	1.48	–	nF
C _{res}	Reverse Transfer Capacitance	V _{CE} = 30 V, V _{GE} = 0 V, f = 100 KHz	–	0.19	–	nF
T _{d,on}	Turn on delay, inductive load	I _C = 600 A, V _{CE} = 400 V T _{vj} = 25°C V _{GE} = +15/–8 V T _{vj} = 150°C R _{g,on} = 4.7 Ω T _{vj} = 175°C	–	377 382 382	–	ns
T _r	Rise time, inductive load	I _C = 600 A, V _{CE} = 400 V T _{vj} = 25°C V _{GE} = +15/–8 V T _{vj} = 150°C R _{g,on} = 4.7 Ω T _{vj} = 175°C	–	104 127 132	–	ns
T _{d,off}	Turn off delay, inductive load	I _C = 600 A, V _{CE} = 400 V T _{vj} = 25°C V _{GE} = +15/–8 V T _{vj} = 150°C R _{g,off} = 15 Ω T _{vj} = 175°C	–	917 1042 1075	–	ns
T _f	Fall time, inductive load	I _C = 600 A, V _{CE} = 400 V T _{vj} = 25°C V _{GE} = +15/–8 V T _{vj} = 150°C R _{g,off} = 15 Ω T _{vj} = 175°C	–	129 199 212	–	ns
E _{ON}	Turn-On Switching Loss (including diode reverse recovery loss)	I _C = 600 A, V _{CE} = 400 V, V _{GE} = +15/–8 V, L _s = 20 nH, R _{g,on} = 4,7 Ω di/dt (T _{vj} = 25°C) = 4.77 A/ns di/dt (T _{vj} = 175°C) = 3.78 A/ns T _{vj} = 25°C T _{vj} = 150°C T _{vj} = 175°C	–	 22.93 35.87 37.70	–	mJ
E _{OFF}	Turn-Off Switching Loss	I _C = 600 A, V _{CE} = 400 V, V _{GE} = +15/–8 V, L _s = 20 nH, R _{g,off} = 15 Ω dv/dt (T _{vj} = 25°C) = 2.79 V/ns dv/dt (T _{vj} = 175°C) = 2.05 V/ns T _{vj} = 25°C T _{vj} = 150°C T _{vj} = 175°C	–	 33.57 47.30 49.09	–	mJ
E _{SC}	Minimum Short Circuit Energy Withstand	V _{GE} = 15 V, V _{CC} = 400 V T _{vj} = 25°C T _{vj} = 175°C	5	5		J

Product parametric performance is indicated in the Electrical Characteristics for the listed test conditions, unless otherwise noted. Product performance may not be indicated by the Electrical Characteristics if operated under different conditions.

VE-Trac™ Dual Gen II NVG800A75L4DSB2

TYPICAL CHARACTERISTICS

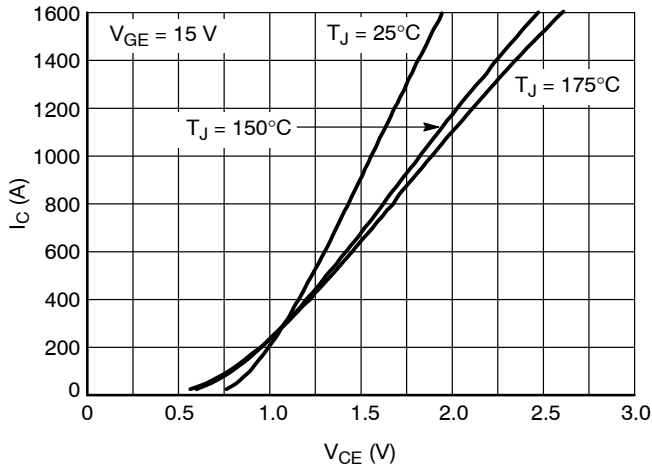

Figure 1. IGBT Output Characteristic

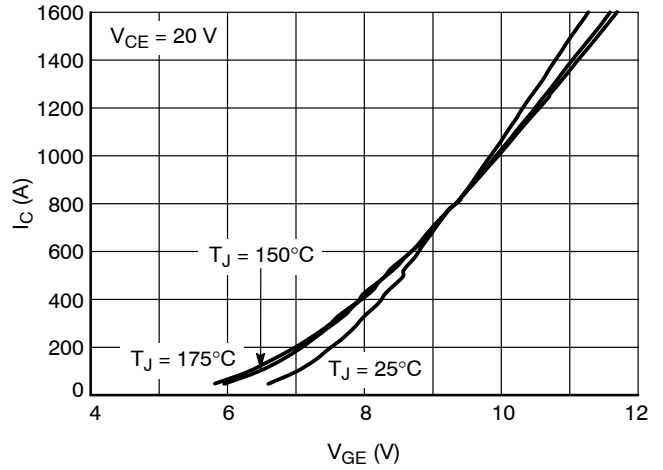

Figure 2. IGBT Transfer Characteristic

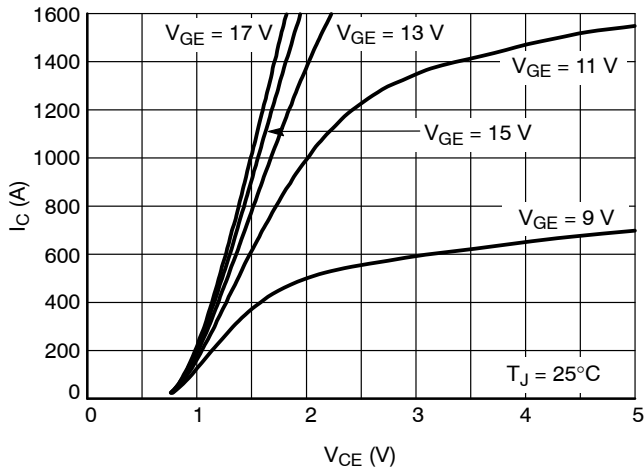

Figure 3. IGBT Output Characteristic, 25°C

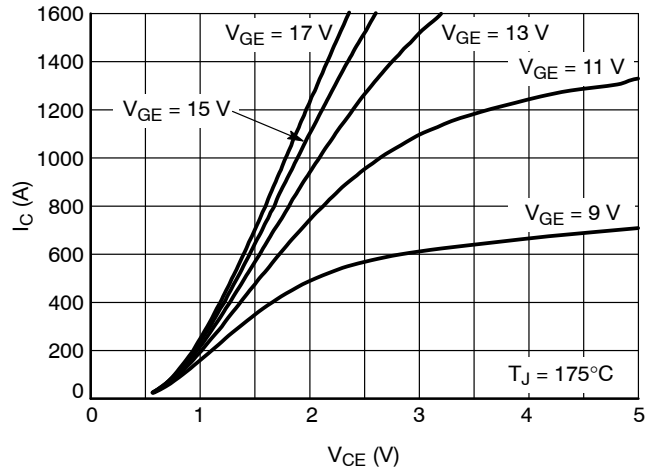

Figure 4. IGBT Output Characteristic, 175°C

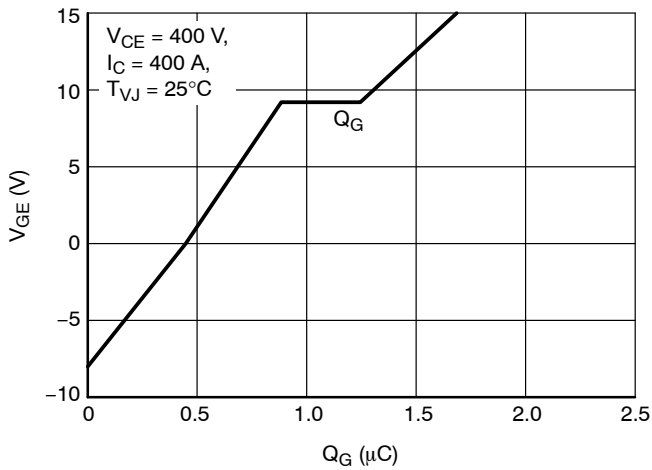

Figure 5. Gate Charge Characteristics

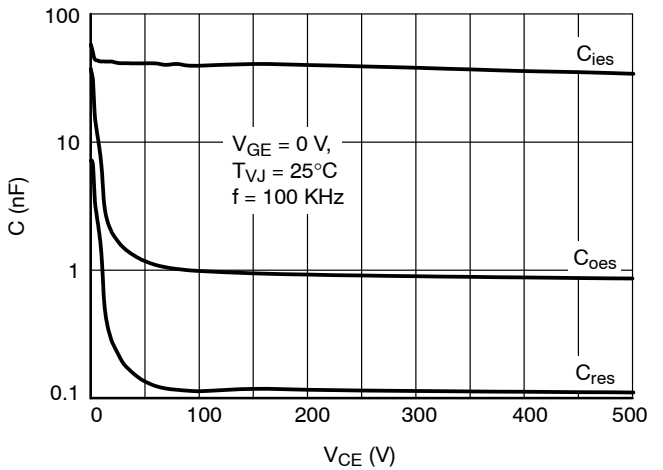

Figure 6. Capacitance Characteristics

VE-Trac™ Dual Gen II NVG800A75L4DSB2

TYPICAL CHARACTERISTICS

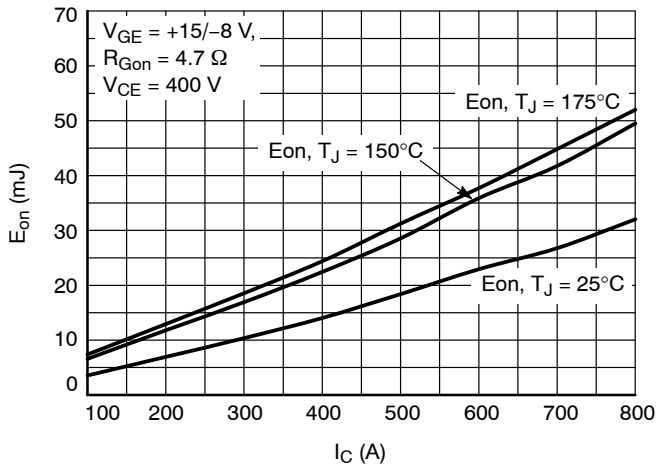

Figure 7. E_{on} vs. I_C

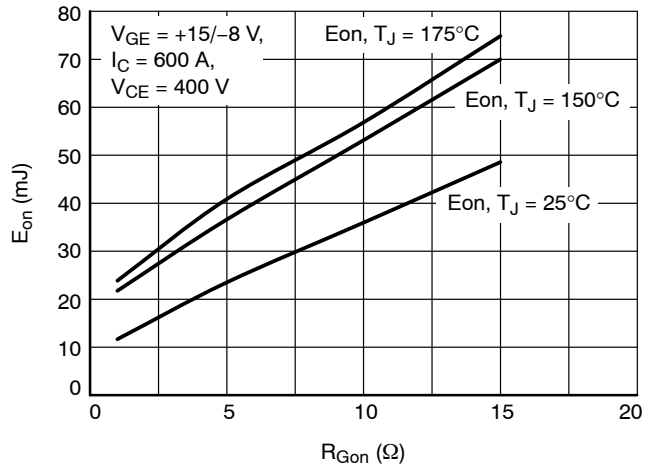

Figure 8. E_{on} vs. R_{Gon}

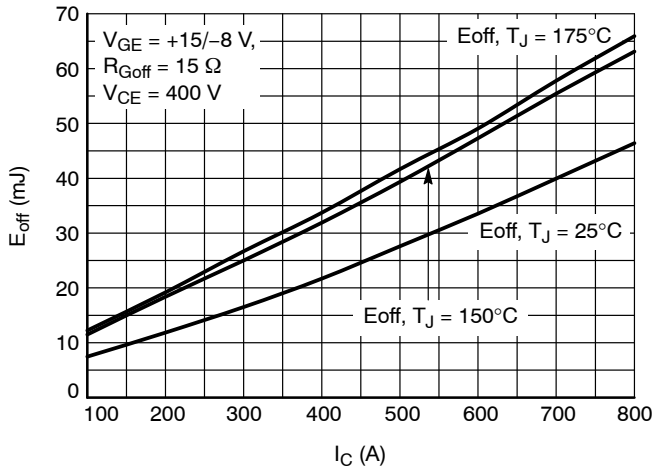

Figure 9. E_{off} vs. I_C

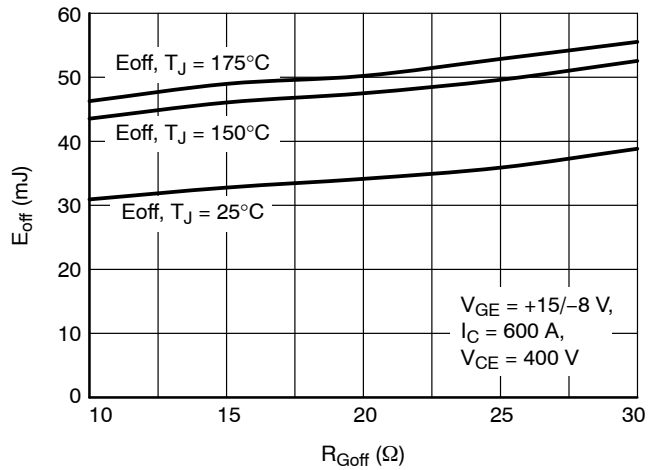

Figure 10. E_{off} vs. R_{Goff}

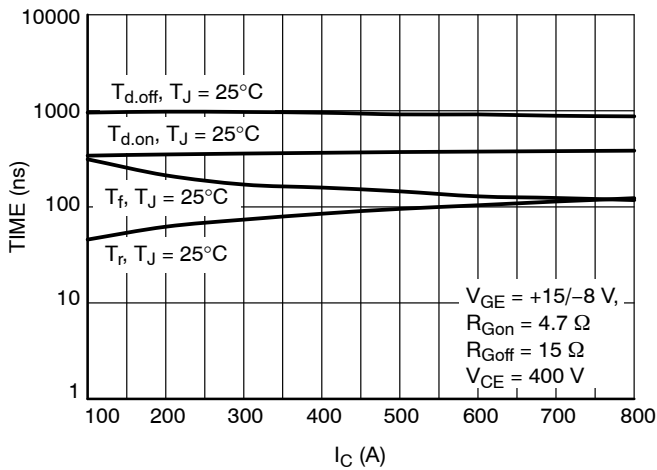

Figure 11. IGBT Switching Times vs. I_C , $T_{VJ} = 25^\circ\text{C}$

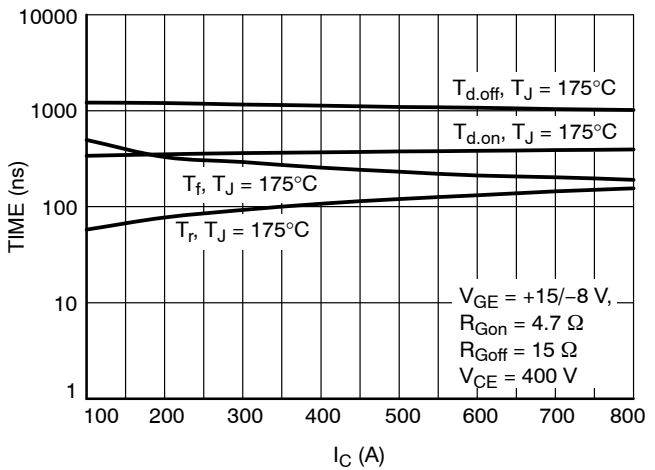

Figure 12. IGBT Switching Times vs. I_C , $T_{VJ} = 175^\circ\text{C}$

VE-Trac™ Dual Gen II NVG800A75L4DSB2

TYPICAL CHARACTERISTICS

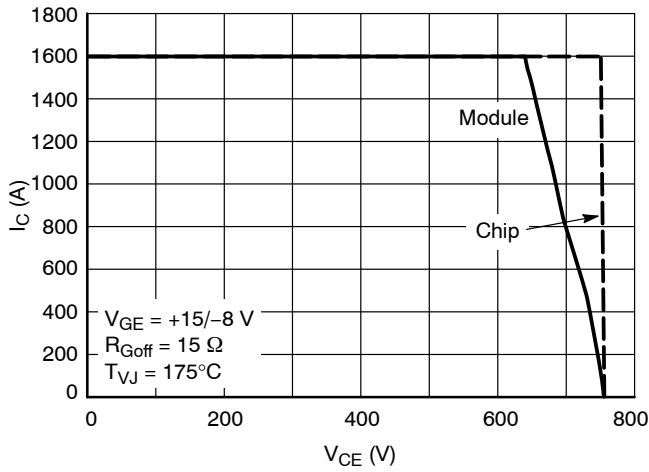

Figure 13. Reverse Bias Safe Operating Area

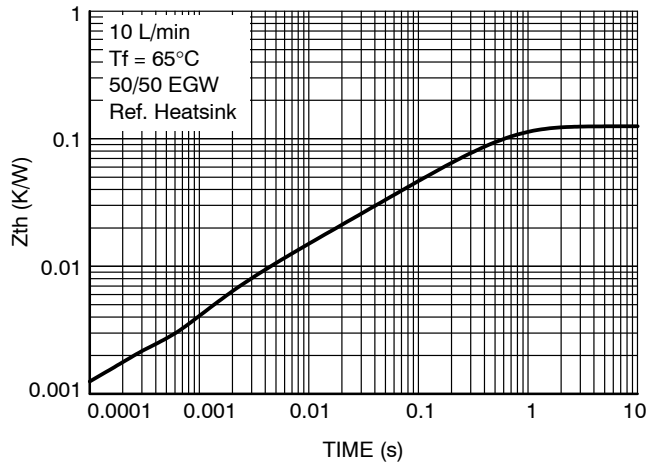

Figure 14. IGBT Transient Thermal Impedance

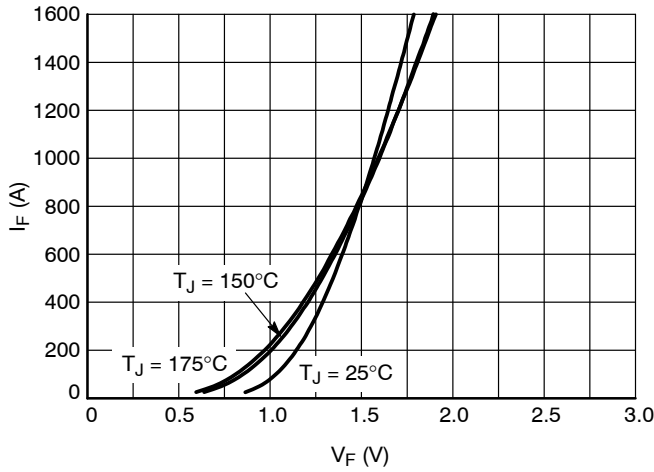

Figure 15. Diode Forward Characteristic

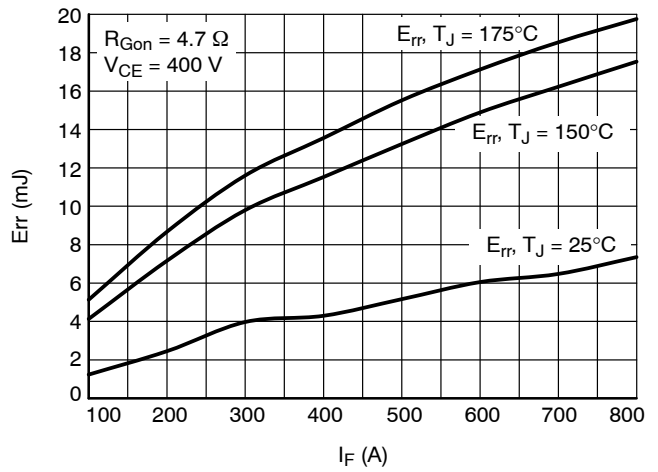

Figure 16. Diode Switching Losses vs. I_F

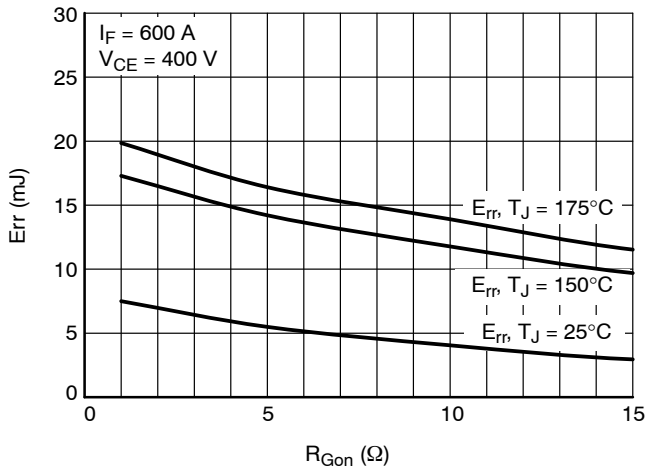

Figure 17. Diode Switching Losses vs. R_{GoN}

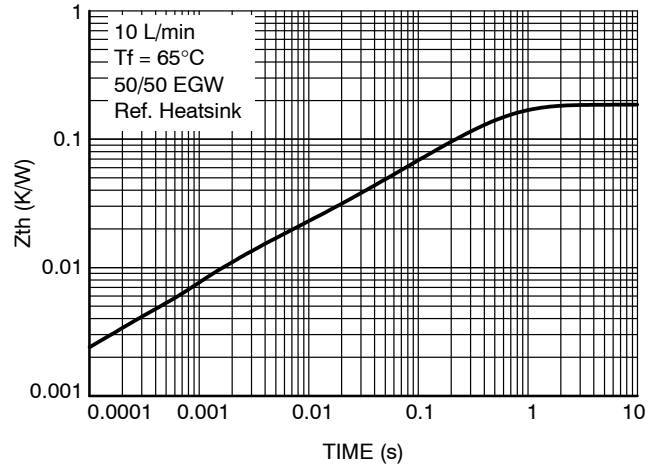

Figure 18. Diode Transient Thermal Impedance

VE-Trac™ Dual Gen II NVG800A75L4DSB2

TYPICAL CHARACTERISTICS

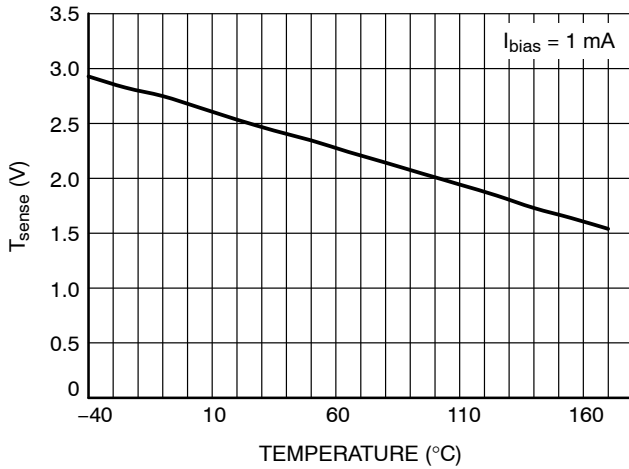

Figure 19. Temperature Sensor Characteristics

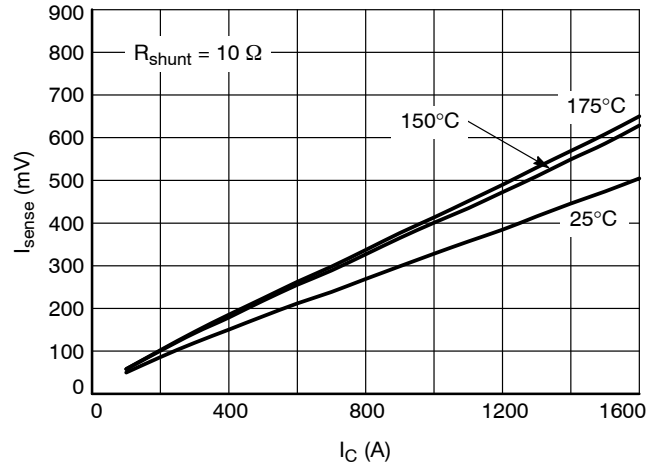

Figure 20. Current Sensor Characteristic

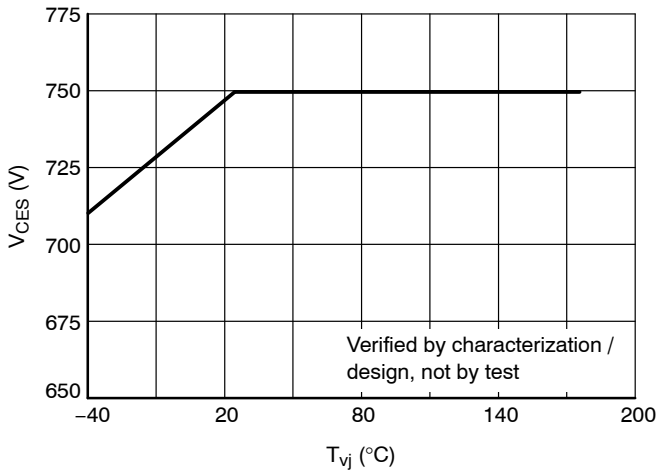

Figure 21. Maximum Allowed V_{CE}

General Note: These are preliminary values measured from a small number of DV units. Values will be updated based on higher quantity of PV measurements.

MECHANICAL CASE OUTLINE PACKAGE DIMENSIONS



Gen II DSC AHPM15-CEC CASE MODHV ISSUE O

DATE 16 DEC 2021

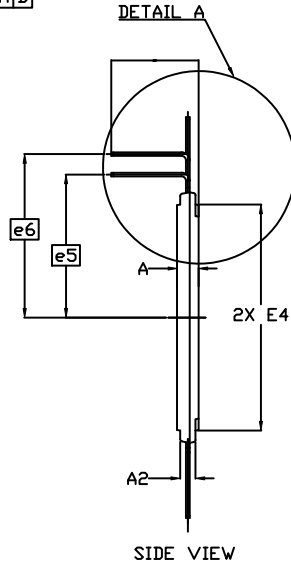
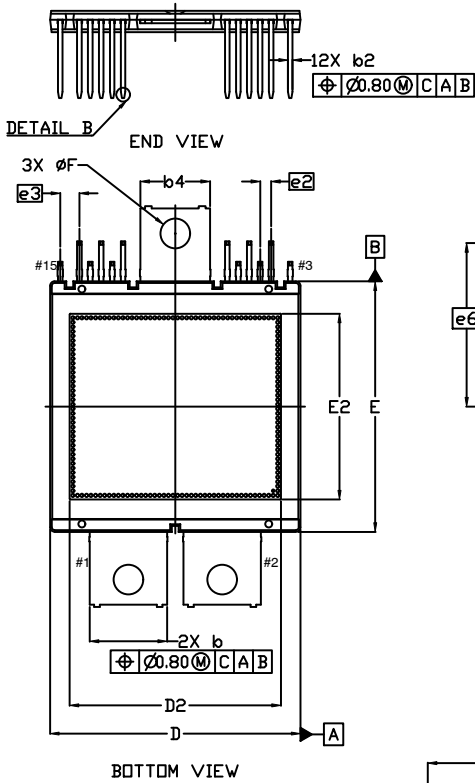
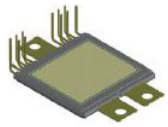

- NOTES:
1. DIMENSIONING AND TOLERANCING PER: ASME Y14.5M, 2009.
 2. CONTROLLING DIMENSION: MILLIMETERS
 3. DIMENSIONS D & E DO NOT INCLUDE MOLD PROTRUSIONS
 4. DIMENSIONS b & b2 DO NOT INCLUDE DAMBAR REMAIN.
 5. MARKING AREA.

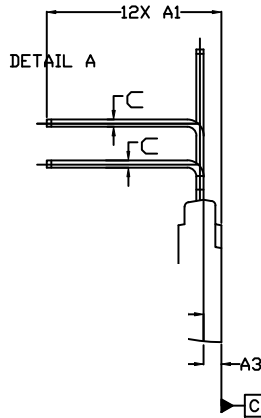
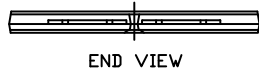
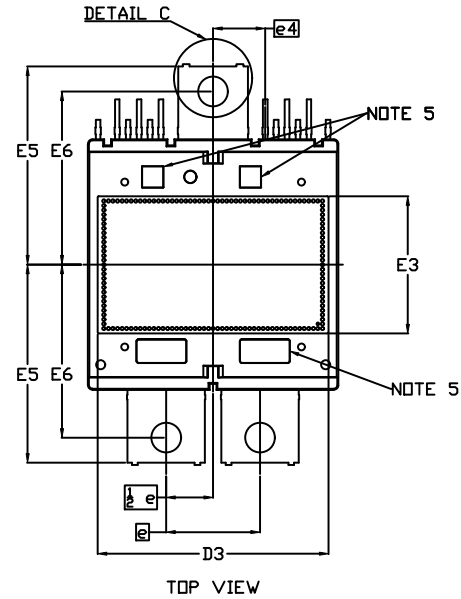

DIM	MILLIMETERS		
	MIN.	NOM.	MAX.
A	4.65	4.70	4.75
A1	18.82	19.17	19.52
A2	3.20	3.40	3.60
A3	1.95 REF		
A4	2.75 REF		
b	16.90	17.00	17.10
b2	0.90	1.00	1.10
b3	0.50 REF		
b4	15.20	15.30	15.40
c	0.70	0.80	0.90
D	54.80	55.00	55.20
D2	45.80	46.80	47.80
D3	50.50	51.20	51.90
E	54.80	55.00	55.20

DIM	MILLIMETERS		
	MIN.	NOM.	MAX.
E2	40.20	41.20	42.20
E3	29.80	30.50	31.20
E4	49.40	49.60	49.80
E5	43.35	43.70	44.05
E6	37.70	38.00	38.30
e	20.60 BSC		
e2	2.40 BSC		
e3	4.20 BSC		
e4	11.45 BSC		
e5	31.40 BSC		
e6	35.90 BSC		
F	6.45	6.50	6.55
L	0.50 REF		
M	10* REF		

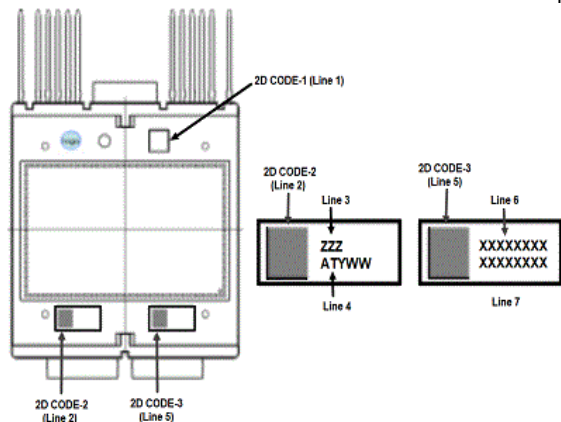

DOCUMENT NUMBER:	98AON39931H	Electronic versions are uncontrolled except when accessed directly from the Document Repository. Printed versions are uncontrolled except when stamped "CONTROLLED COPY" in red.
DESCRIPTION:	Gen II DSC AHPM15-CEC	PAGE 1 OF 2

onsemi and ONSEMI are trademarks of Semiconductor Components Industries, LLC dba onsemi or its subsidiaries in the United States and/or other countries. onsemi reserves the right to make changes without further notice to any products herein. onsemi makes no warranty, representation or guarantee regarding the suitability of its products for any particular purpose, nor does onsemi assume any liability arising out of the application or use of any product or circuit, and specifically disclaims any and all liability, including without limitation special, consequential or incidental damages. onsemi does not convey any license under its patent rights nor the rights of others.

MECHANICAL CASE OUTLINE
PACKAGE DIMENSIONS



Gen II DSC AHPM15-CEC
CASE MODHV
ISSUE 0

DATE 16 DEC 2021

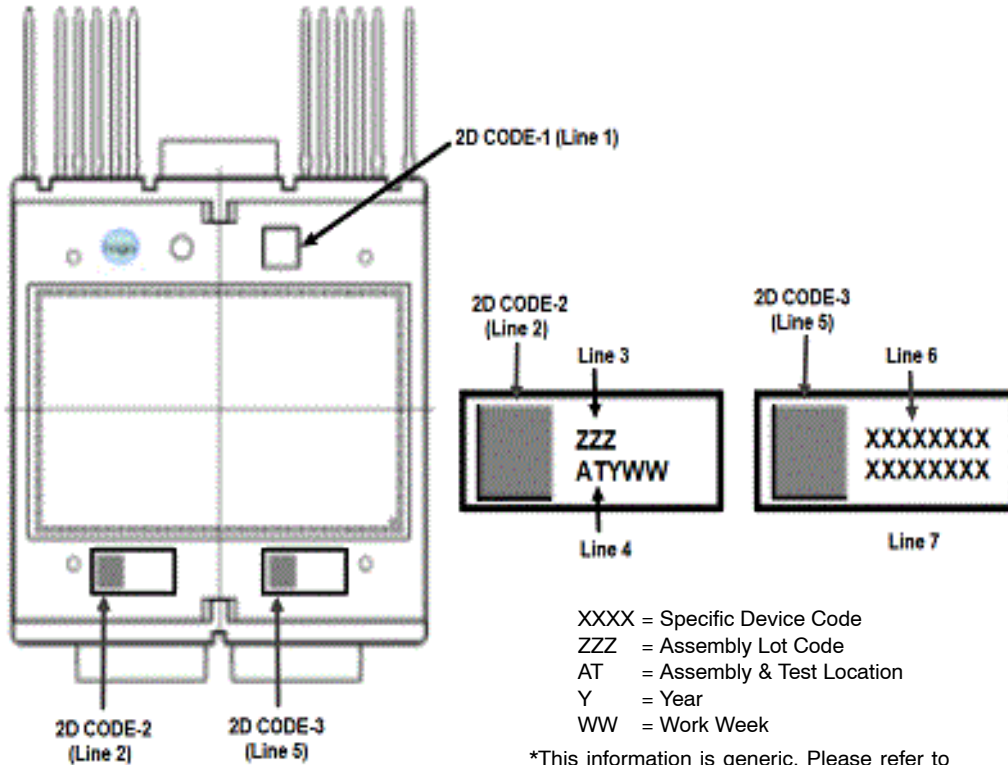

*This information is generic. Please refer to device data sheet for actual part marking. Pb-Free indicator, "G" or microdot "▪", may or may not be present. Some products may not follow the Generic Marking.

DOCUMENT NUMBER:	98AON39931H	Electronic versions are uncontrolled except when accessed directly from the Document Repository. Printed versions are uncontrolled except when stamped "CONTROLLED COPY" in red.
DESCRIPTION:	Gen II DSC AHPM15-CEC	PAGE 2 OF 2

onsemi and ONSEMI are trademarks of Semiconductor Components Industries, LLC dba onsemi or its subsidiaries in the United States and/or other countries. onsemi reserves the right to make changes without further notice to any products herein. onsemi makes no warranty, representation or guarantee regarding the suitability of its products for any particular purpose, nor does onsemi assume any liability arising out of the application or use of any product or circuit, and specifically disclaims any and all liability, including without limitation special, consequential or incidental damages. onsemi does not convey any license under its patent rights nor the rights of others.

onsemi, **Onsemi**, and other names, marks, and brands are registered and/or common law trademarks of Semiconductor Components Industries, LLC dba "**onsemi**" or its affiliates and/or subsidiaries in the United States and/or other countries. **onsemi** owns the rights to a number of patents, trademarks, copyrights, trade secrets, and other intellectual property. A listing of **onsemi**'s product/patent coverage may be accessed at www.onsemi.com/site/pdf/Patent-Marking.pdf. **onsemi** reserves the right to make changes at any time to any products or information herein, without notice. The information herein is provided "as-is" and **onsemi** makes no warranty, representation or guarantee regarding the accuracy of the information, product features, availability, functionality, or suitability of its products for any particular purpose, nor does **onsemi** assume any liability arising out of the application or use of any product or circuit, and specifically disclaims any and all liability, including without limitation special, consequential or incidental damages. Buyer is responsible for its products and applications using **onsemi** products, including compliance with all laws, regulations and safety requirements or standards, regardless of any support or applications information provided by **onsemi**. "Typical" parameters which may be provided in **onsemi** data sheets and/or specifications can and do vary in different applications and actual performance may vary over time. All operating parameters, including "Typicals" must be validated for each customer application by customer's technical experts. **onsemi** does not convey any license under any of its intellectual property rights nor the rights of others. **onsemi** products are not designed, intended, or authorized for use as a critical component in life support systems or any FDA Class 3 medical devices or medical devices with a same or similar classification in a foreign jurisdiction or any devices intended for implantation in the human body. Should Buyer purchase or use **onsemi** products for any such unintended or unauthorized application, Buyer shall indemnify and hold **onsemi** and its officers, employees, subsidiaries, affiliates, and distributors harmless against all claims, costs, damages, and expenses, and reasonable attorney fees arising out of, directly or indirectly, any claim of personal injury or death associated with such unintended or unauthorized use, even if such claim alleges that **onsemi** was negligent regarding the design or manufacture of the part. **onsemi** is an Equal Opportunity/Affirmative Action Employer. This literature is subject to all applicable copyright laws and is not for resale in any manner.

ADDITIONAL INFORMATION

TECHNICAL PUBLICATIONS:

Technical Library: www.onsemi.com/design/resources/technical-documentation
onsemi Website: www.onsemi.com

ONLINE SUPPORT: www.onsemi.com/support

For additional information, please contact your local Sales Representative at www.onsemi.com/support/sales