

MOSFET - Single N-Channel

150 V, 4.4 mΩ, 187 A

NVBLS4D0N15MC

Features

- Low $R_{DS(on)}$ to Minimize Conduction Losses
- Low Q_G and Capacitance to Minimize Driver Losses
- Lowers Switching Noise/EMI
- AEC-Q101 Qualified and PPAP Capable
- These Devices are Pb-Free, Halogen Free/BFR Free and are RoHS Compliant

Typical Applications

- Power Tools, Battery Operated Vacuums
- UAV/Drones, Material Handling
- BMS/Storage, Home Automation

MAXIMUM RATINGS ($T_J = 25^\circ\text{C}$ unless otherwise noted)

Symbol	Parameter		Value	Unit
V_{DSS}	Drain-to-Source Voltage		150	V
V_{GS}	Gate-to-Source Voltage		± 20	V
I_D	Continuous Drain Current $R_{\theta JC}$ (Note 2)	Steady State	$T_C = 25^\circ\text{C}$	187
			$T_C = 100^\circ\text{C}$	132
P_D	Power Dissipation $R_{\theta JC}$ (Note 2)	Steady State	$T_C = 25^\circ\text{C}$	316
			$T_C = 100^\circ\text{C}$	158
I_D	Continuous Drain Current $R_{\theta JA}$ (Notes 1, 2)	Steady State	$T_A = 25^\circ\text{C}$	22
			$T_A = 100^\circ\text{C}$	15
P_D	Power Dissipation $R_{\theta JA}$ (Notes 1, 2)	Steady State	$T_A = 25^\circ\text{C}$	4
			$T_A = 100^\circ\text{C}$	2
I_{DM}	Pulsed Drain Current	$T_A = 25^\circ\text{C}, t_p = 10 \mu\text{s}$	900	A
T_J, T_{stg}	Operating Junction and Storage Temperature Range		-55 to +175	$^\circ\text{C}$
I_S	Source Current (Body Diode)		263	A
E_{AS}	Single Pulse Drain-to-Source Avalanche Energy ($I_{LPEAK} = 15.9 \text{ A}$)		2300	mJ
T_L	Lead Temperature Soldering Reflow for Soldering Purposes (1/8" from case for 10 s)		260	$^\circ\text{C}$

Stresses exceeding those listed in the Maximum Ratings table may damage the device. If any of these limits are exceeded, device functionality should not be assumed, damage may occur and reliability may be affected.

1. Surface-mounted on FR4 board using 1 in² pad size, 2 oz Cu pad.
2. The entire application environment impacts the thermal resistance values shown, they are not constants and are only valid for the particular conditions noted.

THERMAL RESISTANCE RATINGS

Symbol	Parameter	Max	Unit
$R_{\theta JC}$	Junction-to-Case – Steady State (Note 2)	0.5	$^\circ\text{C}/\text{W}$
$R_{\theta JA}$	Junction-to-Ambient – Steady State (Note 2)	35.8	

$V_{(BR)DSS}$	$R_{DS(ON) MAX}$	$I_D MAX$
150 V	4.4 mΩ @ 10 V	187 A

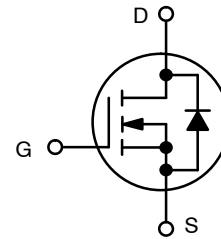

N-CHANNEL MOSFET

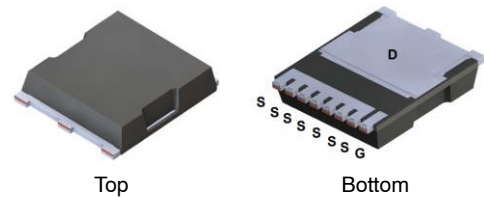

H-PSOF8L 11.68x9.80
MO-299A
CASE 100CU

MARKING DIAGRAM

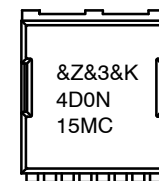

- &Z = Assembly Plant Code
- &3 = Numeric Date Code
- &K = Lot Code
- 4D0N15MC = Specific Device Code

ORDERING INFORMATION

Device	Package	Shipping†
NVBLS4D0N15MC	MO-299A (Pb-Free)	2000 / Tape & Reel

†For information on tape and reel specifications, including part orientation and tape sizes, please refer to our Tape and Reel Packaging Specifications Brochure, BRD8011/D.

NVBLS4D0N15MC

ELECTRICAL CHARACTERISTICS ($T_J = 25^\circ\text{C}$ unless otherwise noted)

Symbol	Parameter	Test Condition	Min	Typ	Max	Unit
--------	-----------	----------------	-----	-----	-----	------

OFF CHARACTERISTICS

$V_{(BR)DSS}$	Drain-to-Source Breakdown Voltage	$V_{GS} = 0\text{ V}, I_D = 250\ \mu\text{A}$	150	-	-	V	
$V_{(BR)DSS} / T_J$	Drain-to-Source Breakdown Voltage Temperature Coefficient	$I_D = 250\ \mu\text{A}$, ref to 25°C	-	30.23	-	mV/ $^\circ\text{C}$	
I_{DSS}	Zero Gate Voltage Drain Current	$V_{GS} = 0\text{ V}, V_{DS} = 120\text{ V}$	$T_J = 25^\circ\text{C}$	-	-	1	μA
			$T_J = 125^\circ\text{C}$	-	-	10	μA
I_{GSS}	Gate-to-Source Leakage Current	$V_{DS} = 0\text{ V}, V_{GS} = \pm 20\text{ V}$	-	-	± 100	nA	

ON CHARACTERISTICS

$V_{GS(TH)}$	Gate Threshold Voltage	$V_{GS} = V_{DS}, I_D = 584\ \mu\text{A}$	2.5	3.7	4.5	V
$V_{GS(TH)} / T_J$	Negative Threshold Temperature Coefficient	$I_D = 250\ \mu\text{A}$, ref to 25°C	-	-10.12	-	mV/ $^\circ\text{C}$
$R_{DS(on)}$	Drain-to-Source On Resistance	$V_{GS} = 10\text{ V}, I_D = 80\text{ A}$	-	3.1	4.4	m Ω
g_{FS}	Forward Transconductance	$V_{DS} = 5\text{ V}, I_D = 80\text{ A}$	-	174	-	S
R_G	Gate-Resistance	$T_A = 25^\circ\text{C}$	-	1.3	-	Ω

CHARGES & CAPACITANCES

C_{ISS}	Input Capacitance	$V_{GS} = 0\text{ V}, f = 1\text{ MHz}, V_{DS} = 75\text{ V}$	-	7490	-	pF
C_{OSS}	Output Capacitance		-	2055	-	
C_{RSS}	Reverse Transfer Capacitance		-	27.2	-	
$Q_{G(TOT)}$	Total Gate Charge	$V_{GS} = 10\text{ V}, V_{DS} = 75\text{ V}, I_D = 80\text{ A}$	-	90.4	-	nC
$Q_{G(TH)}$	Threshold Gate Charge		-	24.7	-	
Q_{GS}	Gate-to-Source Charge		-	40.2	-	
Q_{GD}	Gate-to-Drain Charge		-	12.6	-	
V_{GP}	Plateau Voltage		-	5.7	-	

SWITCHING CHARACTERISTICS, $V_{GS} = 10\text{ V}$ (Note 3)

$t_{d(ON)}$	Turn-On Delay Time	$V_{GS} = 10\text{ V}, V_{DS} = 75\text{ V}, I_D = 80\text{ A}, R_G = 6\ \Omega$	-	47	-	ns
t_r	Rise Time		-	115	-	
$t_{d(OFF)}$	Turn-Off Delay Time		-	58	-	
t_f	Fall Time		-	11	-	

DRAIN-SOURCE DIODE CHARACTERISTICS

V_{SD}	Forward Diode Voltage	$V_{GS} = 0\text{ V}, I_S = 80\text{ A}$	$T_J = 25^\circ\text{C}$	-	0.86	1.2	V
			$T_J = 125^\circ\text{C}$	-	0.75	-	
t_{RR}	Reverse Recovery Time	$V_{GS} = 0\text{ V}, di_S/dt = 100\text{ A}/\mu\text{s}, I_S = 80\text{ A}$	-	84	-	ns	
t_a	Charge Time		-	55	-		
t_b	Discharge Time		-	29	-		
Q_{RR}	Reverse Recovery Charge		-	180	-		nC

Product parametric performance is indicated in the Electrical Characteristics for the listed test conditions, unless otherwise noted. Product performance may not be indicated by the Electrical Characteristics if operated under different conditions.

3. Switching characteristics are independent of operating junction temperatures

NVBLS4D0N15MC

TYPICAL CHARACTERISTICS

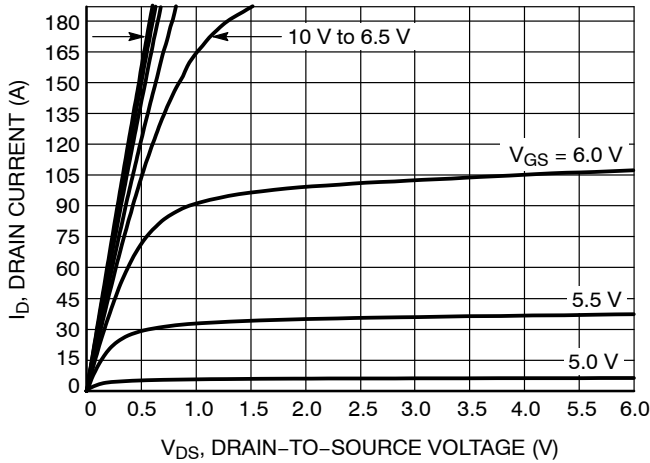

Figure 1. On-Region Characteristics

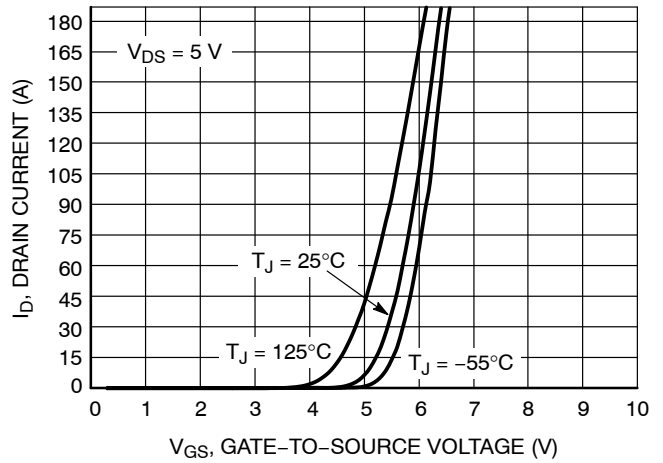

Figure 2. Transfer Characteristics

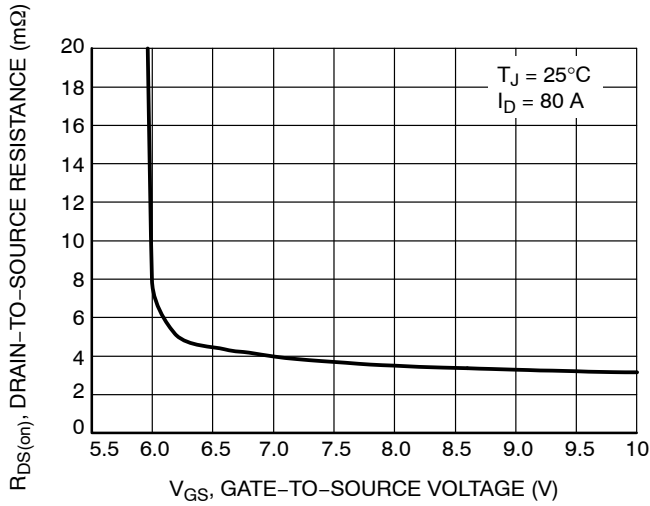

Figure 3. On-Resistance vs. V_{GS}

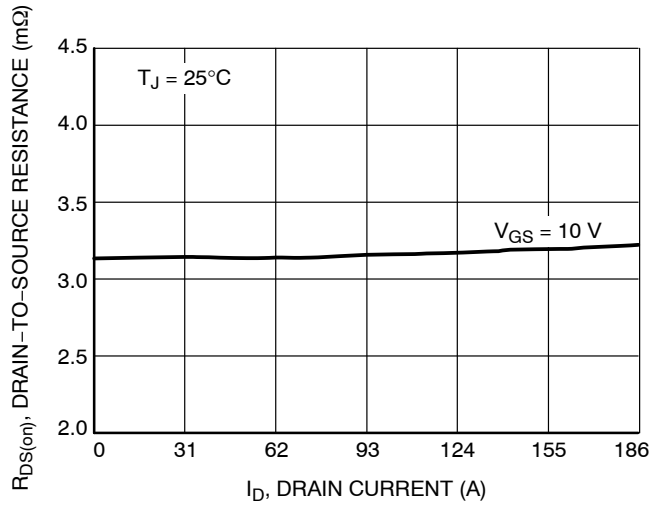

Figure 4. On-Resistance vs. Drain Current and Gate Voltage

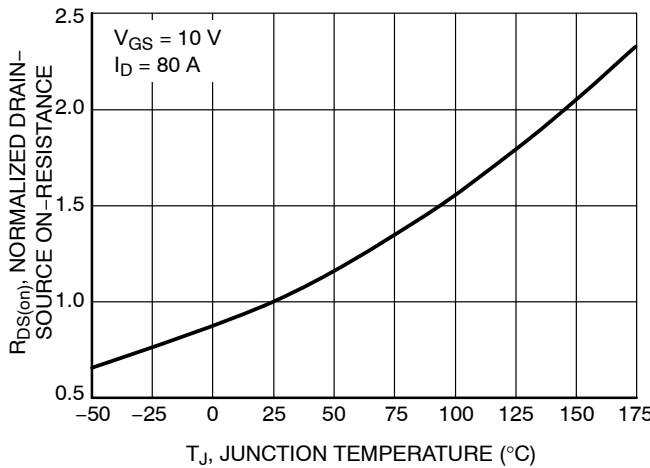

Figure 5. On-Resistance Variation with Temperature

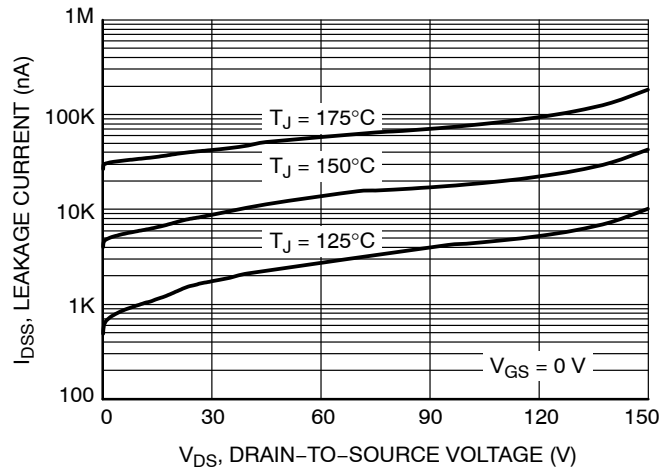

Figure 6. Drain-to-Source Leakage Current vs. Voltage

NVBLS4D0N15MC

TYPICAL CHARACTERISTICS

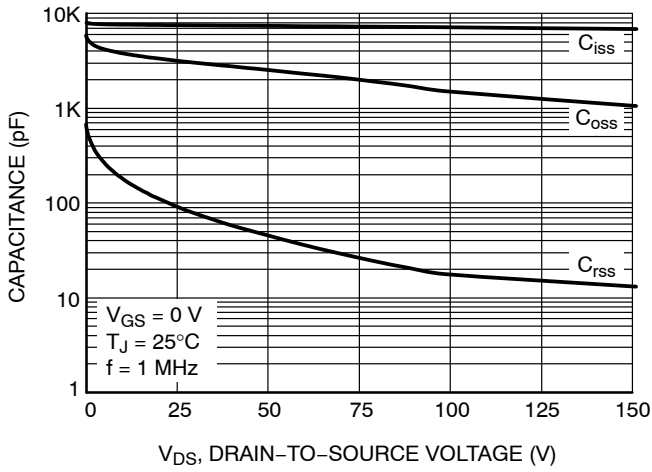

Figure 7. Capacitance Variation

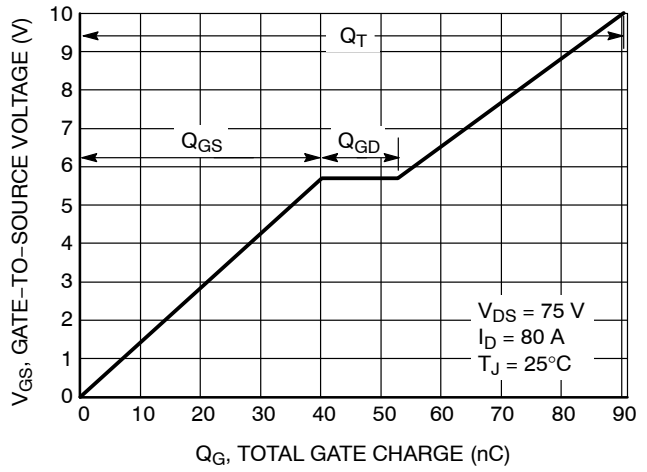

Figure 8. Gate-to-Source Voltage vs. Total Gate Charge

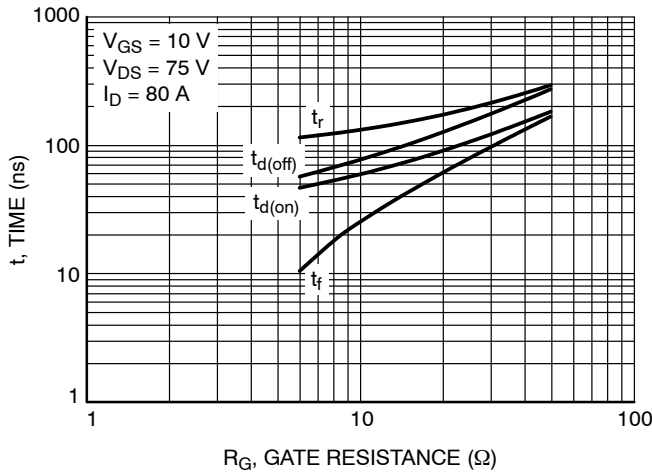

Figure 9. Resistive Switching Time Variation vs. Gate Resistance

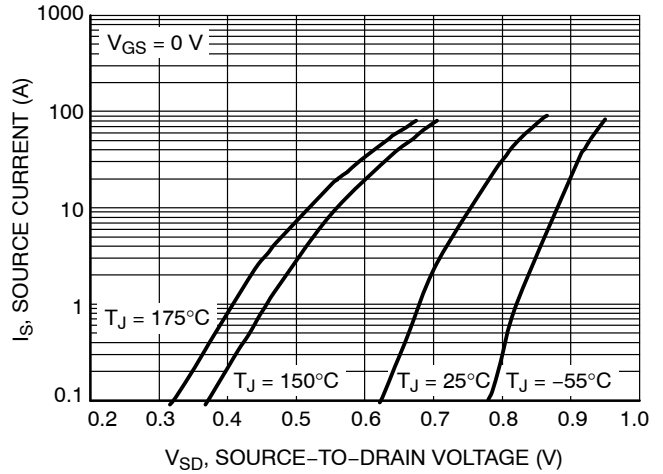

Figure 10. Diode Forward Voltage vs. Current

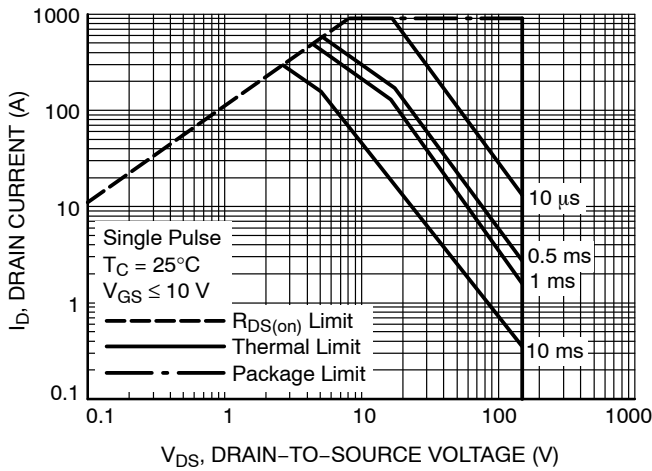

Figure 11. Maximum Rated Forward Biased Safe Operating Area

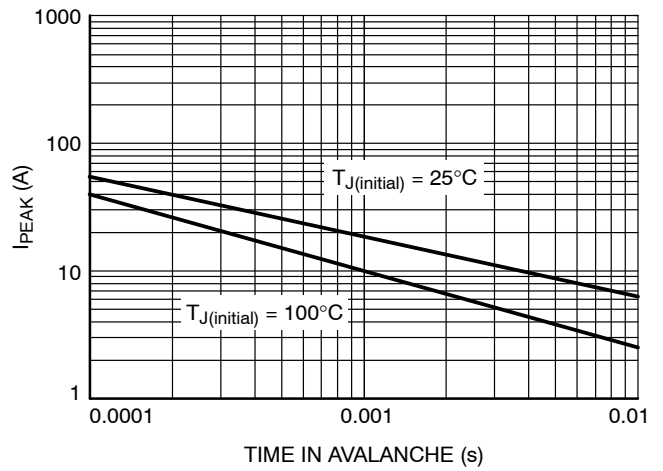

Figure 12. I_{PEAK} vs. Time in Avalanche

NVBLS4D0N15MC

TYPICAL CHARACTERISTICS

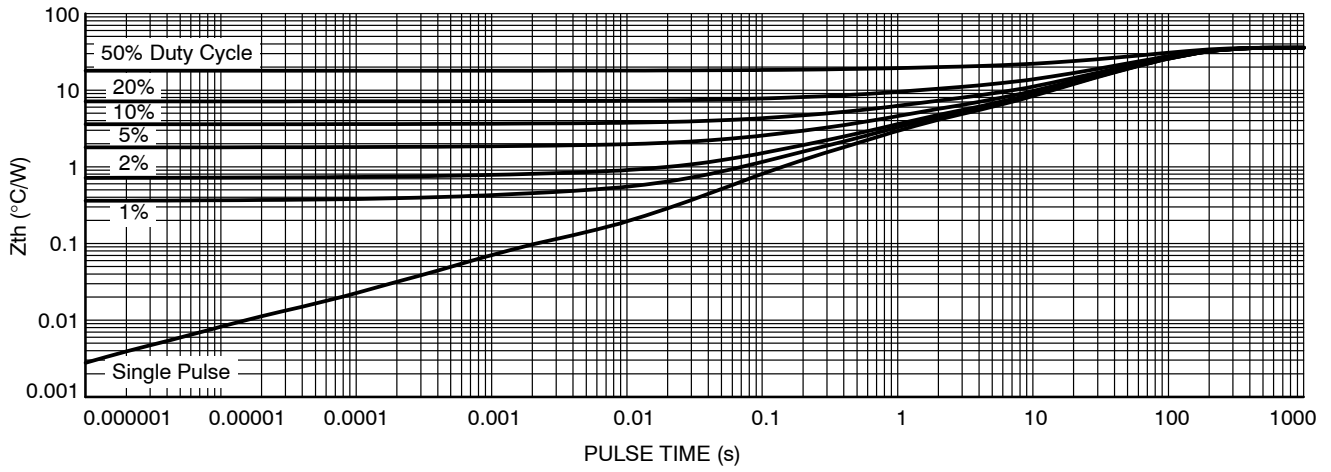

Figure 13. Thermal Characteristics (Junction-to-Ambient)

MECHANICAL CASE OUTLINE PACKAGE DIMENSIONS



H-PSOF8L 11.68x9.80
CASE 100CU
ISSUE C

DATE 22 MAY 2023

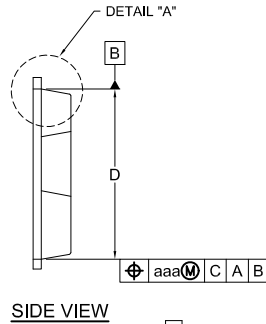

LAND PATTERN RECOMMENDATION

*FOR ADDITIONAL INFORMATION ON OUR PB-FREE STRATEGY AND SOLDERING DETAILS, PLEASE DOWNLOAD THE ON SEMICONDUCTOR SOLDERING AND MOUNTING TECHNIQUES REFERENCE MANUAL, SOLDERRM/D.

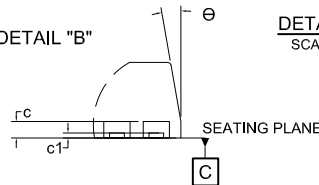

DETAIL "A"
SCALE: 2X

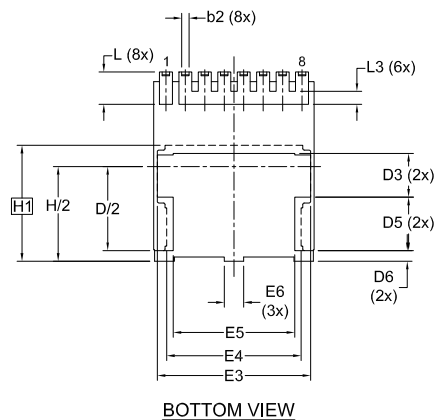

DETAIL "B"
SCALE: 2X

NOTES:

1. PACKAGE STANDARD REFERENCE: JEDEC MO-299, ISSUE A.
2. DIMENSIONING AND TOLERANCING PER ASME Y14.5M, 2009.
3. CONTROLLING DIMENSION: MILLIMETERS.
4. COPLANARITY APPLIES TO THE EXPOSED WELL AS THE TERMINALS.
5. DIMENSIONS D1 AND E1 DO NOT INCLUDE MOLD FLASH, PROTRUSIONS, OR GATE BURRS.
6. SEATING PLANE IS DEFINED BY THE TERMINALS. "A1" IS DEFINED AS THE DISTANCE FROM THE SEATING PLANE TO THE LOWEST POINT ON THE PACKAGE BODY.

DIM	MILLIMETERS		
	MIN.	NOM.	MAX.
A	2.20	2.30	2.40
A1	1.70	1.80	1.90
b	0.70	0.80	0.90
b1	9.70	9.80	9.90
b2	0.35	0.45	0.55
c	0.40	0.50	0.60
c1	0.10	—	—
D	10.28	10.38	10.48
D/2	5.09	5.19	5.29
D1	10.98	11.08	11.18
D2	3.20	3.30	3.40
D3	2.60	2.70	2.80
D4	4.45	4.55	4.65
D5	3.20	3.30	3.40
D6	0.55	0.65	0.75
E	9.80	9.90	10.00
E1	7.30	7.40	7.50
E2	0.30	0.40	0.50
E3	9.36	9.46	9.56

DIM	MILLIMETERS		
	MIN.	NOM.	MAX.
E4	8.20	8.30	8.40
E5	7.40	7.50	7.60
E6	1.10	1.20	1.30
e	1.20 BSC		
e/2	0.60 BSC		
e1	8.40 BSC		
H	11.58	11.68	11.78
H/2	5.74	5.84	5.94
H1	7.15 BSC		
L	1.90	2.00	2.10
L1	0.60	0.70	0.80
L2	0.50	0.60	0.70
L3	0.70	0.80	0.90
theta	0°	—	12°
aaa	0.20		
bbb	0.25		
ccc	0.20		
ddd	0.20		
eee	0.10		

GENERIC MARKING DIAGRAM*

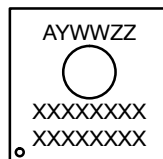

- A = Assembly Location
- Y = Year
- WW = Work Week
- ZZ = Assembly Lot Code
- XXXX = Specific Device Code

*This information is generic. Please refer to device data sheet for actual part marking. Pb-Free indicator, "G" or microdot "a", may or may not be present. Some products may not follow the Generic Marking.

DOCUMENT NUMBER:	98AON13813G	Electronic versions are uncontrolled except when accessed directly from the Document Repository. Printed versions are uncontrolled except when stamped "CONTROLLED COPY" in red.
DESCRIPTION:	H-PSOF8L 11.68x9.80	PAGE 1 OF 1

onsemi and ONSEMI are trademarks of Semiconductor Components Industries, LLC dba onsemi or its subsidiaries in the United States and/or other countries. onsemi reserves the right to make changes without further notice to any products herein. onsemi makes no warranty, representation or guarantee regarding the suitability of its products for any particular purpose, nor does onsemi assume any liability arising out of the application or use of any product or circuit, and specifically disclaims any and all liability, including without limitation special, consequential or incidental damages. onsemi does not convey any license under its patent rights nor the rights of others.

onsemi, **Onsemi**, and other names, marks, and brands are registered and/or common law trademarks of Semiconductor Components Industries, LLC dba "**onsemi**" or its affiliates and/or subsidiaries in the United States and/or other countries. **onsemi** owns the rights to a number of patents, trademarks, copyrights, trade secrets, and other intellectual property. A listing of **onsemi**'s product/patent coverage may be accessed at www.onsemi.com/site/pdf/Patent-Marking.pdf. **onsemi** reserves the right to make changes at any time to any products or information herein, without notice. The information herein is provided "as-is" and **onsemi** makes no warranty, representation or guarantee regarding the accuracy of the information, product features, availability, functionality, or suitability of its products for any particular purpose, nor does **onsemi** assume any liability arising out of the application or use of any product or circuit, and specifically disclaims any and all liability, including without limitation special, consequential or incidental damages. Buyer is responsible for its products and applications using **onsemi** products, including compliance with all laws, regulations and safety requirements or standards, regardless of any support or applications information provided by **onsemi**. "Typical" parameters which may be provided in **onsemi** data sheets and/or specifications can and do vary in different applications and actual performance may vary over time. All operating parameters, including "Typicals" must be validated for each customer application by customer's technical experts. **onsemi** does not convey any license under any of its intellectual property rights nor the rights of others. **onsemi** products are not designed, intended, or authorized for use as a critical component in life support systems or any FDA Class 3 medical devices or medical devices with a same or similar classification in a foreign jurisdiction or any devices intended for implantation in the human body. Should Buyer purchase or use **onsemi** products for any such unintended or unauthorized application, Buyer shall indemnify and hold **onsemi** and its officers, employees, subsidiaries, affiliates, and distributors harmless against all claims, costs, damages, and expenses, and reasonable attorney fees arising out of, directly or indirectly, any claim of personal injury or death associated with such unintended or unauthorized use, even if such claim alleges that **onsemi** was negligent regarding the design or manufacture of the part. **onsemi** is an Equal Opportunity/Affirmative Action Employer. This literature is subject to all applicable copyright laws and is not for resale in any manner.

ADDITIONAL INFORMATION

TECHNICAL PUBLICATIONS:

Technical Library: www.onsemi.com/design/resources/technical-documentation
onsemi Website: www.onsemi.com

ONLINE SUPPORT: www.onsemi.com/support

For additional information, please contact your local Sales Representative at www.onsemi.com/support/sales