

# NUS3116MT

## Main Switch Power MOSFET and Dual Charging BJT

-12 V, -6.2 A, Single P-Channel with Dual PNP low  $V_{ce(sat)}$  Transistors, 3x3 mm WDFN Package

This device integrates one high performance power MOSFET and two low  $V_{ce(sat)}$  transistors, greatly reducing the layout space and optimizing charging performance in the battery-powered portable electronics.

### Features

- High Performance Power MOSFET
- Dual-Low  $V_{ce(sat)}$  Transistors as Charging Power Mux
- 3.0x3.0x0.8 mm WDFN Package
- Independent Pin-out Provides Circuit Flexibility
- Low Profile (<0.8 mm) for Easy Fit in Thin Environments
- This is a Pb-Free Device

### Applications

- Main Switch and Battery Charging Mux for Portable Electronics
- Optimized for Commercial PMUs from Top Suppliers (See Figure 2)

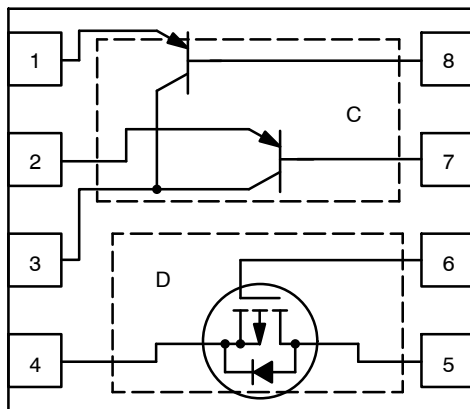

DFN8 3x3 Pin Connections  
(Top View)

Figure 1. Simple Schematic



ON Semiconductor®

[www.onsemi.com](http://www.onsemi.com)

### MOSFET

$V_{(BR)DSS}$	$R_{DS(on)}$ TYP	$I_D$ MAX
-12 V	32 mΩ @ -4.5 V	-6.2 A
	44 mΩ @ -2.5 V	

### Low $V_{ce(sat)}$ PNP (Wall)

$V_{CE0}$ MAX	$V_{EBO}$ MAX	$I_C$ MAX
-30 V	-8.0 V	-2.0 A

### Low $V_{ce(sat)}$ PNP (USB)

$V_{CE0}$ MAX	$V_{EBO}$ MAX	$I_C$ MAX
-30 V	-8.0 V	-2.0 A



DFN8  
CASE 506BC

### MARKING DIAGRAM

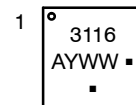

3116 = Device Code  
 A = Assembly Location  
 Y = Year  
 WW = Work Week  
 ■ = Pb-Free Package  
 (Note: Microdot may be in either location)

### ORDERING INFORMATION

Device	Package	Shipping†
NUS3116MTR2G	WDFN8 (Pb-Free)	3000/Tape & Reel

†For information on tape and reel specifications, including part orientation and tape sizes, please refer to our Tape and Reel Packaging Specification Brochure, BRD8011/D.

# NUS3116MT

## P-Channel Power MOSFET Maximum Ratings ( $T_J = 25^\circ\text{C}$ unless otherwise stated)

Parameter		Symbol	Value	Units	
Drain-to-Source Voltage		$V_{DSS}$	-12	V	
Gate-to-Source Voltage		$V_{GS}$	$\pm 8.0$	V	
Continuous Drain Current (Note 1)	Steady State	$T_A = 25^\circ\text{C}$	-5.47	A	
		$T_A = 85^\circ\text{C}$	-4.0		
	$t \leq 5\text{ s}$	$T_A = 25^\circ\text{C}$	-6.2		
Power Dissipation (Note 1)	Steady State	$T_A = 25^\circ\text{C}$	1.7	W	
	$t \leq 5\text{ s}$		2.2		
Continuous Drain Current (Note 2, Minimum Pad)	Steady State	$T_A = 25^\circ\text{C}$	-4.4	A	
		$T_A = 85^\circ\text{C}$	-3.2		
Power Dissipation (Note 2)		$T_A = 25^\circ\text{C}$	1.14	W	
Pulsed Drain Current	$t_p = 10\ \mu\text{s}$		$I_{DM}$	-25	A
Operating Junction and Storage Temperature		$T_J, T_{STG}$	-55 to 150	$^\circ\text{C}$	
Source Current (Body Diode) <sup>2</sup>		$I_S$	-2.8	A	
Lead Temperature for Soldering Purposes (1/8" from case for 10 s)		$T_L$	260	$^\circ\text{C}$	

### THERMAL RESISTANCE RATINGS

Parameter	Symbol	Max	Units
Junction-to-Ambient – Steady State (Note 2)	$R_{\theta JA}$	110	$^\circ\text{C/W}$
Junction-to-Ambient – $t < 10\text{ s}$ (Note 2)	$R_{\theta JA}$	56	$^\circ\text{C/W}$
Junction-to-Ambient – Steady State (Note 1)	$R_{\theta JA}$	72	$^\circ\text{C/W}$
Junction-to-Ambient – $t < 10\text{ s}$ (Note 1)	$R_{\theta JA}$	40	$^\circ\text{C/W}$

Stresses exceeding those listed in the Maximum Ratings table may damage the device. If any of these limits are exceeded, device functionality should not be assumed, damage may occur and reliability may be affected.

- Surface-mounted on FR4 board using 1 in sq pad size (Cu area = 1.127 in sq [1 oz] including traces)
- Surface-mounted on FR4 board using the minimum recommended pad size of 0.5 in sq, 1 oz. Cu.

## P-Channel MOSFET Electrical Characteristics ( $T_J = 25^\circ\text{C}$ unless otherwise specified)

Parameter	Symbol	Test Condition	Min	Typ	Max	Units
<b>OFF CHARACTERISTICS</b>						
Drain-to-Source Breakdown Voltage	$V_{(BR)DSS}$	$V_{GS} = 0\text{ V}, I_D = -250\ \mu\text{A}$	-12.0			V
Drain-to-Source Breakdown Voltage Temperature Coefficient	$V_{(BR)DSS}/T_J$	$I_D = -250\ \mu\text{A}, \text{ref to } 25^\circ\text{C}$		-10.1		$\text{mV}/^\circ\text{C}$
Zero Gate Voltage Drain Current	$I_{DSS}$	$V_{GS} = 0\text{ V}, V_{DS} = -12\text{ V}$	$T_J = 25^\circ\text{C}$		-1.0	$\mu\text{A}$
			$T_J = 125^\circ\text{C}$		-10	
Gate-to-Source Leakage Current	$I_{GSS}$	$V_{DS} = 0\text{ V}, V_{GS} = \pm 8\text{ V}$			$\pm 200$	nA

### ON CHARACTERISTICS (Note 3)

Gate Threshold Voltage	$V_{GS(TH)}$	$V_{GS} = V_{DS}, I_D = -250\ \mu\text{A}$	-0.45	-0.67	-1.1	V
Negative Threshold Temperature Coefficient	$V_{GS(TH)}/T_J$			2.68		$\text{mV}/^\circ\text{C}$
Drain-to-Source On Resistance	$R_{DS(on)}$	$V_{GS} = -4.5\text{ V}, I_D = -3.0\text{ A}$		32	40	m $\Omega$
		$V_{GS} = -2.5\text{ V}, I_D = -3.0\text{ A}$		44	50	
Forward Transconductance	$g_{FS}$	$V_{DS} = -16\text{ V}, I_D = -3.0\text{ A}$		5.9		S

- Pulsed Condition: Pulse Width = 300  $\mu\text{sec}$ , Duty Cycle  $\leq 2\%$

# NUS3116MT

## P-Channel MOSFET Electrical Characteristics (T<sub>J</sub> = 25°C unless otherwise specified)

Parameter	Symbol	Test Condition	Min	Typ	Max	Units
<b>CHARGES, CAPACITANCES AND GATE RESISTANCE</b>						
Input Capacitance	C <sub>ISS</sub>	V <sub>GS</sub> = 0 V, f = 1.0 MHz, V <sub>DS</sub> = -12 V		1329		pF
Output Capacitance	C <sub>OSS</sub>			200		
Reverse Transfer Capacitance	C <sub>RSS</sub>			116		
Total Gate Charge	Q <sub>G(tot)</sub>	V <sub>GS</sub> = -4.5 V, V <sub>DS</sub> = -12 V, I <sub>D</sub> = -3.0 A		13		nC
Threshold Gate Charge	Q <sub>G(th)</sub>			1.5		
Gate-to-Source Charge	Q <sub>GS</sub>			2.2		
Gate-to-Drain Charge	Q <sub>GD</sub>			2.9		

## SWITCHING CHARACTERISTICS

Turn-On Delay Time	t <sub>d(on)</sub>	V <sub>GS</sub> = -4.5 V, V <sub>DD</sub> = -12 V, I <sub>D</sub> = -3.0 A, R <sub>G</sub> = 3.0		8		ns
Rise Time	t <sub>r</sub>			17.5		
Turn-Off Delay Time	t <sub>d(off)</sub>			80		
Fall Time	t <sub>f</sub>			56.5		

## DRAIN-SOURCE DIODE CHARACTERISTICS

Forward Recovery Voltage	V <sub>SD</sub>	V <sub>GS</sub> = 0 V, I <sub>S</sub> = -1.0 A	T <sub>J</sub> = 25°C		-0.66	-1.2	V
			T <sub>J</sub> = 125°C		-0.54		
Reverse Recovery Time	t <sub>rr</sub>	V <sub>GS</sub> = 0 V, dI <sub>SD</sub> /dt = 100 A/μs, I <sub>S</sub> = -1.0 A		70.8		ns	
Charge Time	t <sub>a</sub>			14.3			
Discharge Time	t <sub>b</sub>			56.4			
Reverse Recovery Charge	Q <sub>RR</sub>			44		nC	

3. Pulsed Condition: Pulse Width = 300 μsec, Duty Cycle ≤ 2%

## Dual-PNP Transistors Maximum Ratings (T<sub>J</sub> = 25°C unless otherwise stated)

Parameter	Symbol	Value	Units
Collector-Emitter Voltage	V <sub>CEO</sub>	-30	V
Collector-Base Voltage	V <sub>CBO</sub>	-30	V
Emitter-Base Voltage	V <sub>EBO</sub>	-8.0	V
Collector Current, Continuous	I <sub>C</sub>	-2.0	A
Collector Current, Pulsed (Note 4)	I <sub>C</sub>	-6.0	A
Operating Junction and Storage Temperature	T <sub>J</sub> , T <sub>STG</sub>	-55 to 150	°C
Thermal Resistance Dissipation	P <sub>D</sub>	1.5	W
Thermal Resistance (Note 5)	R <sub>θJA</sub>	83	°C/W
Thermal Resistance Dissipation	P <sub>D</sub>	810	mW
Thermal Resistance (Note 6)	R <sub>θJA</sub>	155	°C/W

4. Single Pulse: Pulse Width = 1 ms

5. Surface-mounted on FR4 board using 1 in sq pad size (Cu area = 1.127 in sq [1 oz] including traces)

6. Surface-mounted on FR4 board using the minimum recommended pad size of 100 mm<sup>2</sup>, 1 oz. Cu.

# NUS3116MT

## Dual-PNP Transistors Electrical Characteristics ( $T_J = 25^\circ\text{C}$ unless otherwise stated)

Parameter	Symbol	Test Condition	Min	Typ	Max	Units
-----------	--------	----------------	-----	-----	-----	-------

### OFF CHARACTERISTICS

Collector-Emitter Voltage	$V_{CE0}$	$I_C = -10\text{ mA}, I_B = 0$	-30			V
Collector-Base Voltage	$V_{CBO}$	$I_C = -0.1\text{ mA}, I_E = 0$	-30			V
Emitter-Base Voltage	$V_{EBO}$	$I_E = -0.1\text{ mA}, I_C = 0$	-8.0			V
Collector-Emitter Cutoff Current	$I_{CES}$	$V_{CES} = -30\text{ V}$			-0.1	$\mu\text{A}$

### ON CHARACTERISTICS

DC Current Gain (Note 7)	$h_{FE}$	$I_C = -1.0\text{ A}, V_{CE} = -2.0\text{ V}$	100	200		-
DC Current Gain (Note 7)	$h_{FE}$	$I_C = -2.0\text{ A}, V_{CE} = -2.0\text{ V}$	100	200		-
Collector-Emitter Saturation Voltage	$V_{CE(sat)}$	$I_C = -1.0\text{ A}, I_B = -0.01\text{ A}$			0.22	V
Collector-Emitter Saturation Voltage	$V_{CE(sat)}$	$I_C = -1.0\text{ A}, I_B = -0.1\text{ A}$			0.12	V
Collector-Emitter Saturation Voltage	$V_{CE(sat)}$	$I_C = -2.0\text{ A}, I_B = -0.2\text{ A}$			0.24	V
Input Capacitance	$C_{ibo}$	$V_{EB} = -0.5\text{ V}, f = 1.0\text{ MHz}$		240	400	pF
Output Capacitance	$C_{obo}$	$V_{CB} = -3.0\text{ V}, f = 1.0\text{ MHz}$		50	100	pF

7. Pulsed Condition: Pulse Width = 300  $\mu\text{sec}$ , Duty Cycle  $\leq 2\%$

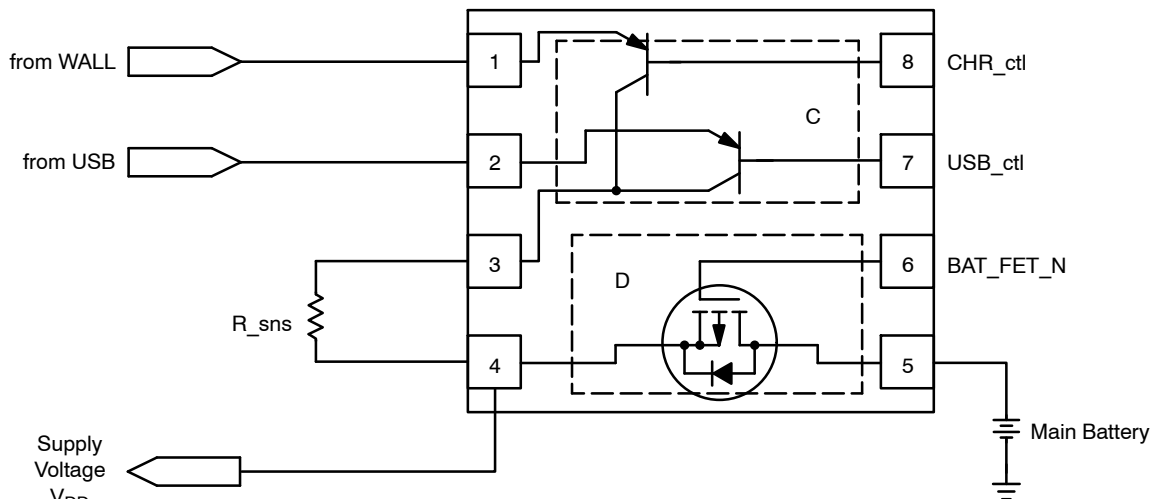

Figure 2. Typical Application Circuit

TYPICAL CHARACTERISTICS - MOSFET

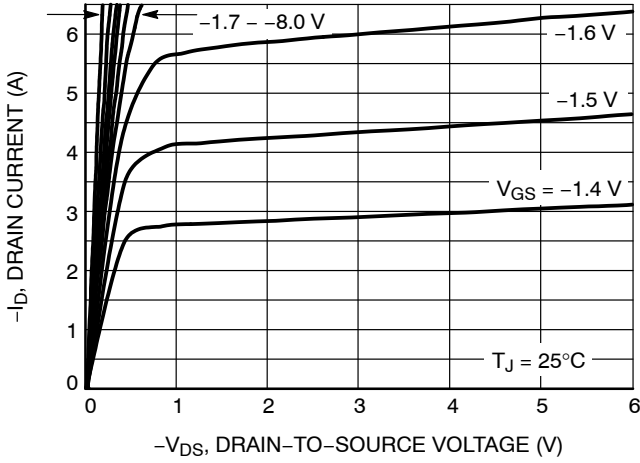

Figure 3. On-Region Characteristics

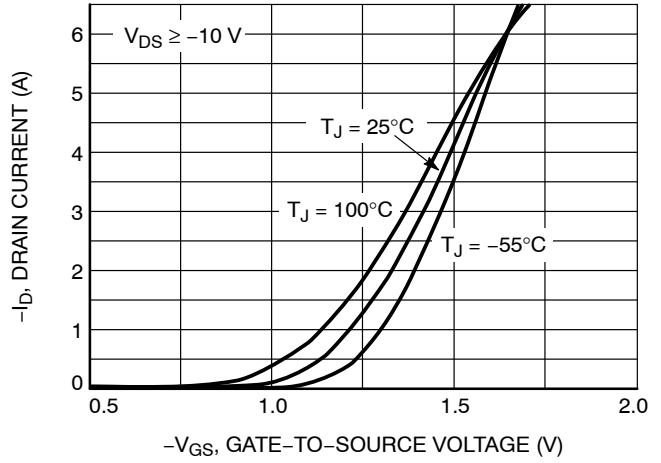

Figure 4. Transfer Characteristics

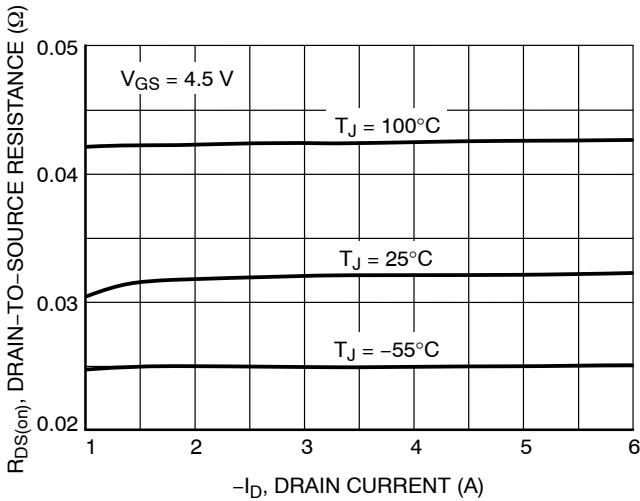

Figure 5. On-Resistance vs. Drain Current

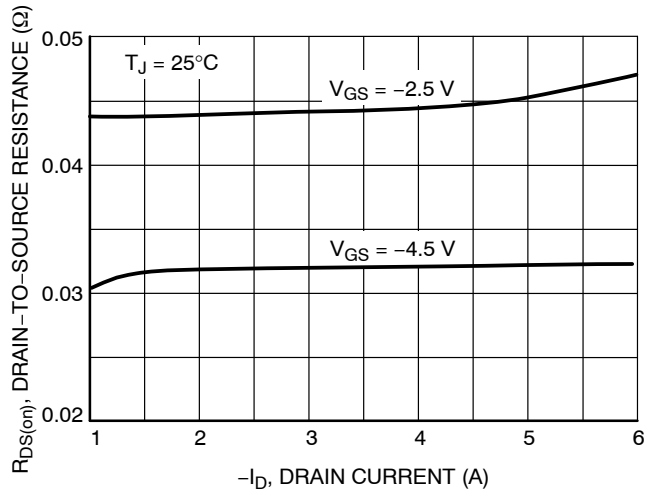

Figure 6. On-Resistance vs. Drain Current and Gate Voltage

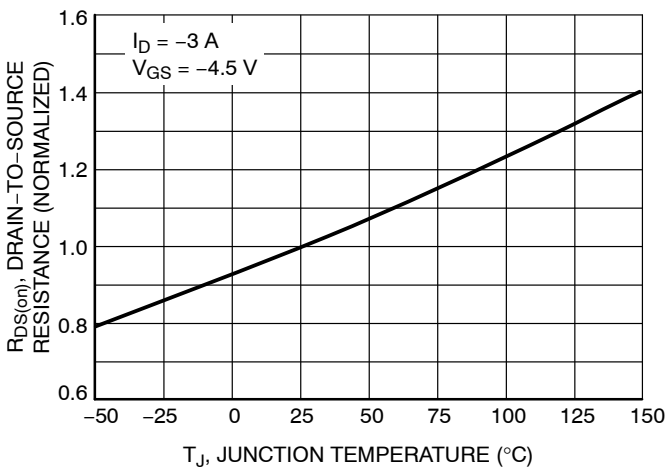

Figure 7. On-Resistance Variation with Temperature

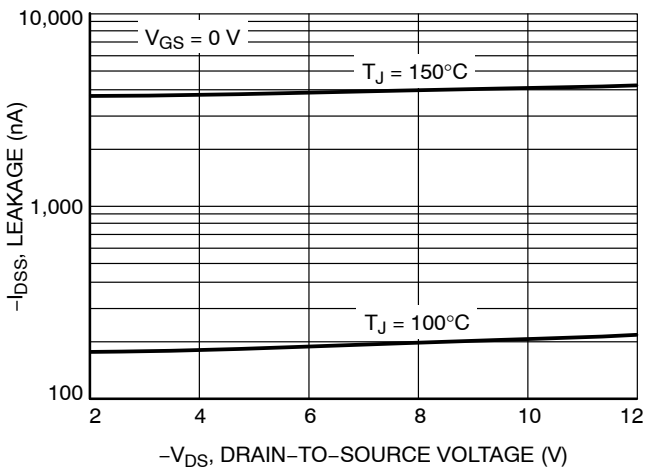

Figure 8. Drain-to-Source Leakage Current vs. Voltage

TYPICAL CHARACTERISTICS - MOSFET

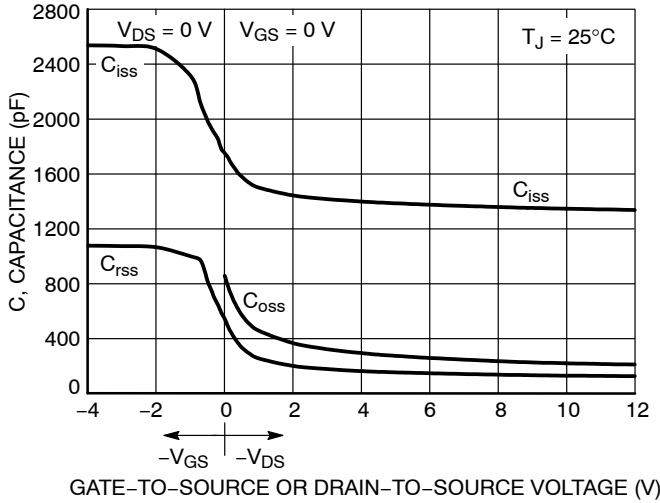

Figure 9. Capacitance Variation

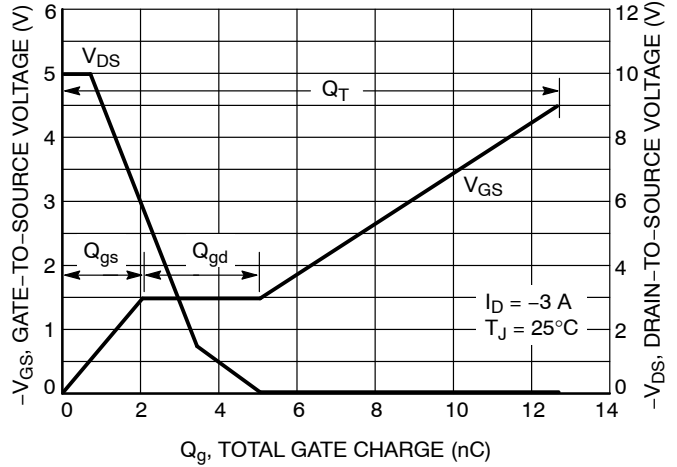

Figure 10. Gate-to-Source and Drain-to-Source Voltage vs. Total Charge

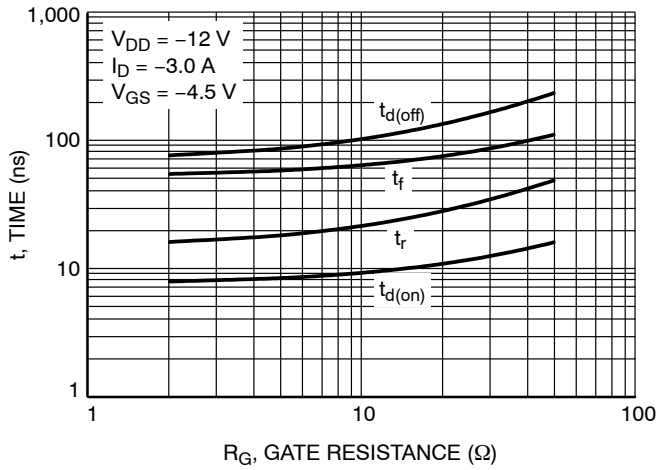

Figure 11. Resistive Switching Time Variation vs. Gate Resistance

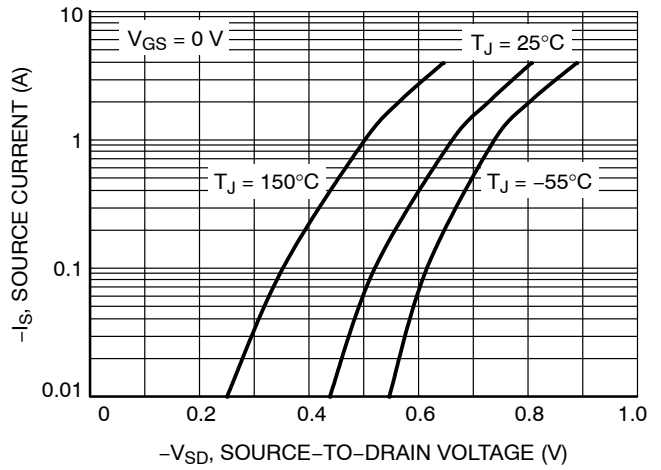
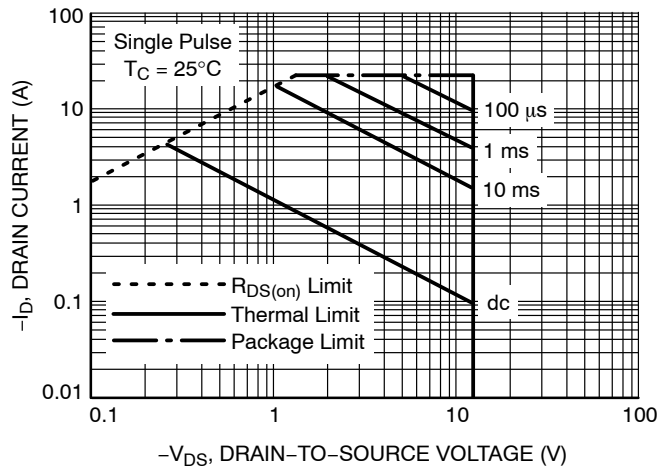

Figure 12. Diode Forward Voltage vs. Current



Mounted on 2" sq. FR4 board (0.5" sq. 2 oz. Cu single sided) with MOSFET die operating.

Figure 13. Maximum Rated Forward Biased Safe Operating Area

# NUS3116MT

## TYPICAL CHARACTERISTICS - MOSFET

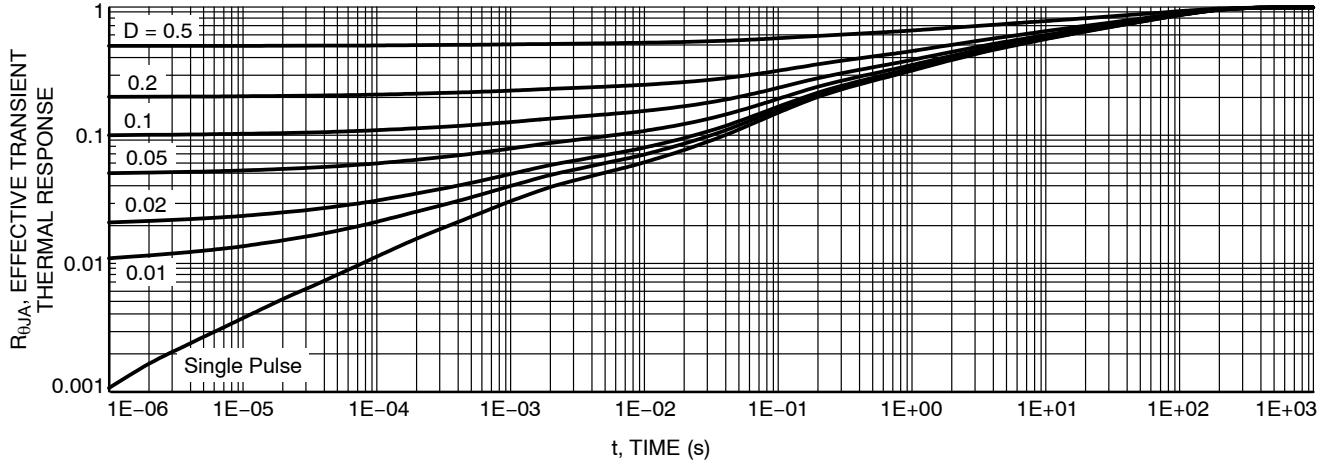

Figure 14. FET Thermal Response

TYPICAL CHARACTERISTICS – BJT

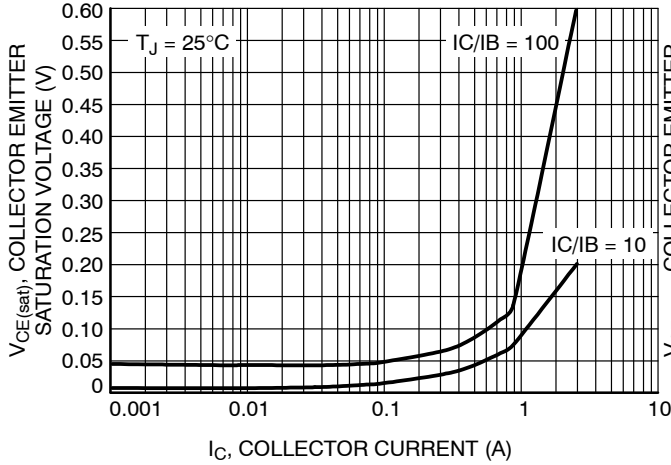

Figure 15. Collector Emitter Saturation Voltage vs. Collector Current

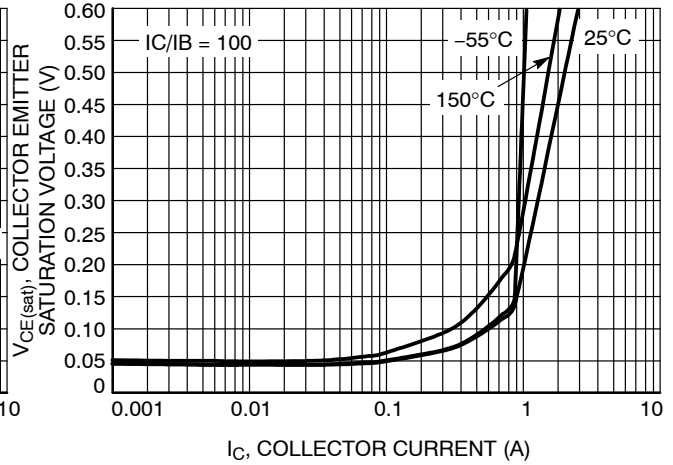

Figure 16. Collector Emitter Saturation Voltage vs. Collector Current

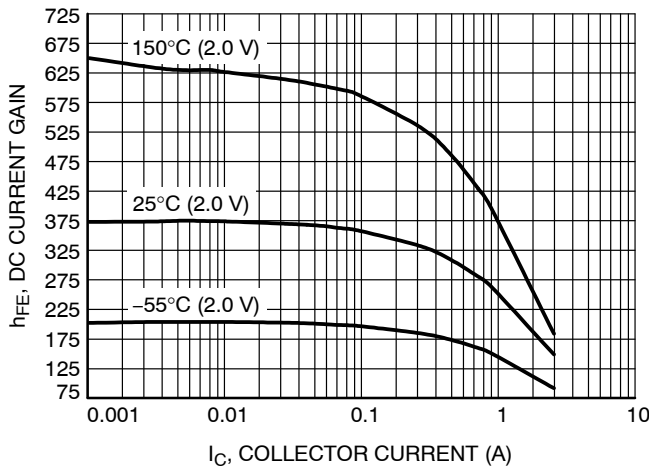

Figure 17. DC Current Gain vs. Collector Current

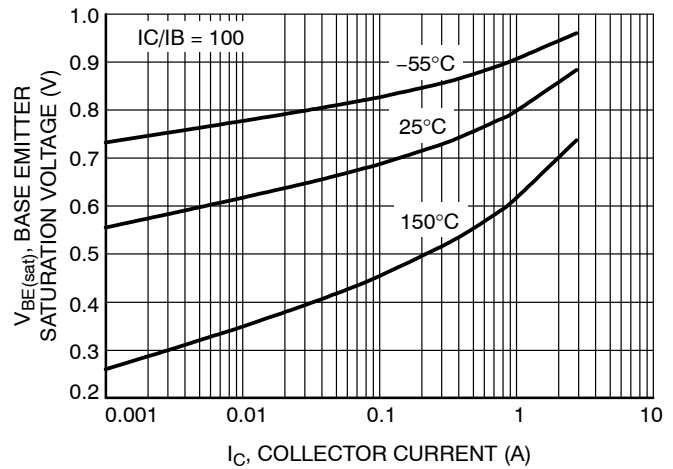

Figure 18. Base Emitter Saturation Voltage vs. Collector Current

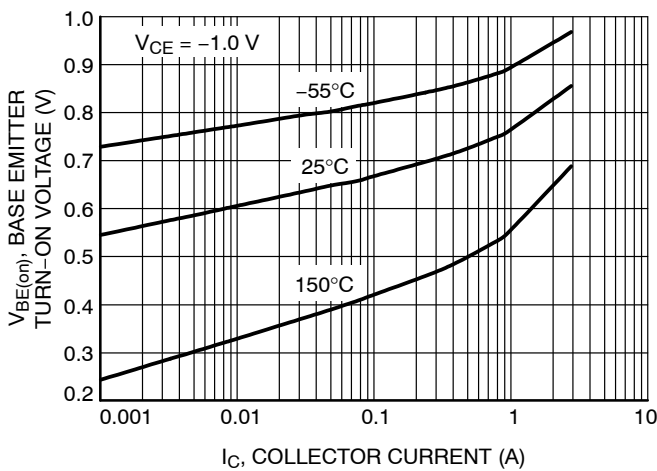

Figure 19. Base Emitter Turn-On Voltage vs. Collector Current

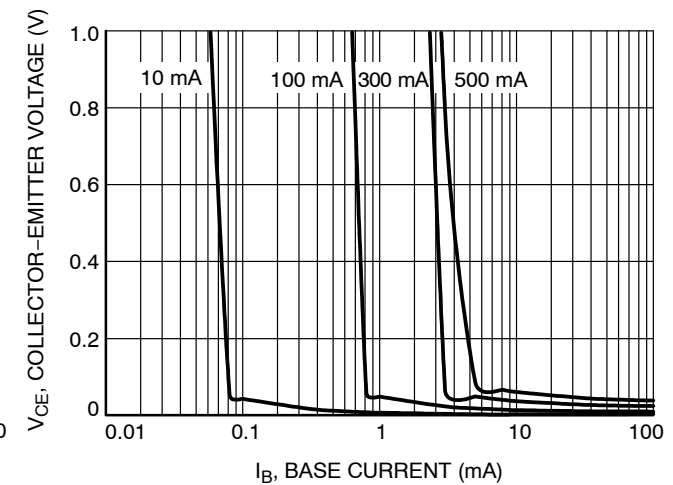

Figure 20. Saturation Region



# NUS3116MT

## TYPICAL CHARACTERISTICS - BJT

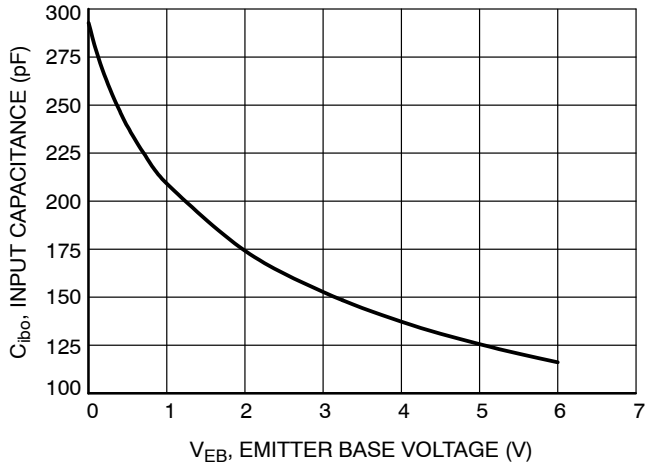

Figure 21. Input Capacitance

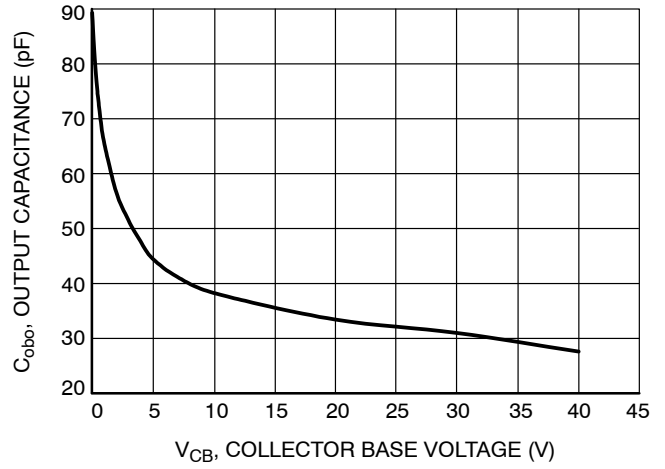

Figure 22. Output Capacitance

# MECHANICAL CASE OUTLINE

## PACKAGE DIMENSIONS

ON Semiconductor®



SCALE 2:1

**WDFN8, 3x3, 0.65P**  
CASE 506BC-01  
ISSUE A

DATE 28 MAY 2008

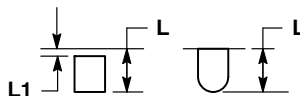
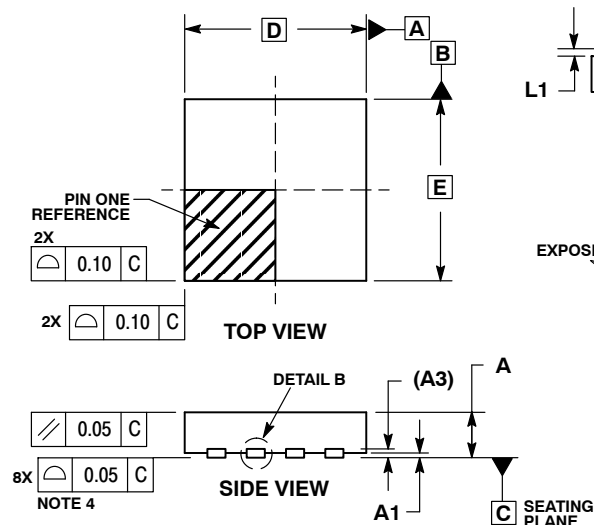

**DETAIL A**  
OPTIONAL  
CONSTRUCTIONS

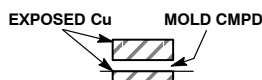

**DETAIL B**  
OPTIONAL  
CONSTRUCTIONS

**NOTES:**

1. DIMENSIONING AND TOLERANCING PER ASME Y14.5M, 1994.
2. CONTROLLING DIMENSION: MILLIMETERS.
3. DIMENSION b APPLIES TO PLATED TERMINAL AND IS MEASURED BETWEEN 0.15 AND 0.30mm.
4. COPLANARITY APPLIES TO THE EXPOSED PAD AS WELL AS THE TERMINALS.

MILLIMETERS		
DIM	MIN	MAX
A	0.70	0.80
A1	0.00	0.05
A3	0.20	REF
b	0.25	0.35
D	3.00	BSC
D2	1.00	1.20
D3	0.95	1.15
E	3.00	BSC
E2	1.70	1.90
e	0.65	BSC
G2	0.15	BSC
G3	0.20	BSC
K	0.20	---
L	0.25	0.45
L1	---	0.15

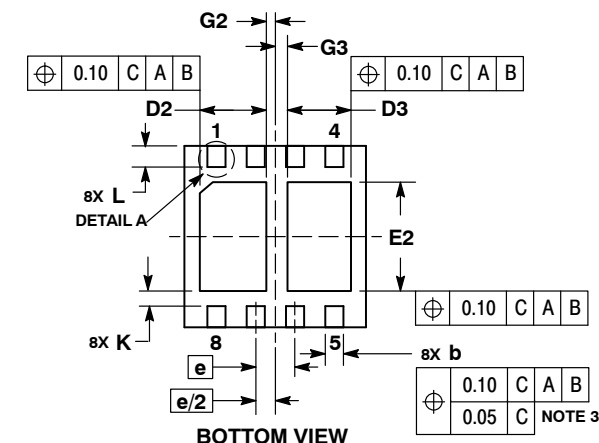

**GENERIC MARKING DIAGRAM\***

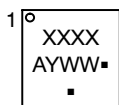

- XXXX = Specific Device Code
- A = Assembly Location
- Y = Year
- WW = Work Week
- = Pb-Free Package

\*This information is generic. Please refer to device data sheet for actual part marking.  
Pb-Free indicator, "G" or microdot "■", may or may not be present.

**SOLDERING FOOTPRINT\***

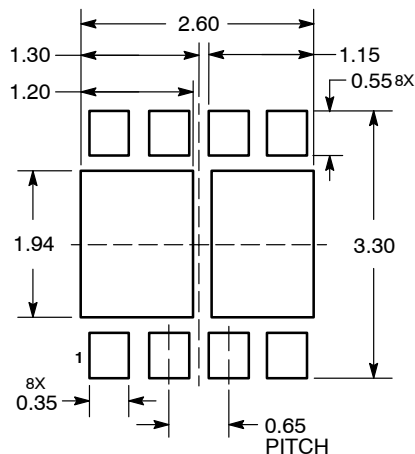

DIMENSIONS: MILLIMETERS

\*For additional information on our Pb-Free strategy and soldering details, please download the ON Semiconductor Soldering and Mounting Techniques Reference Manual, SOLDERRM/D.

<b>DOCUMENT NUMBER:</b>	<b>98AON23220D</b>	Electronic versions are uncontrolled except when accessed directly from the Document Repository. Printed versions are uncontrolled except when stamped "CONTROLLED COPY" in red.
<b>DESCRIPTION:</b>	<b>WDFN8, 3X3, 0.65P, DUAL FLAG</b>	<b>PAGE 1 OF 1</b>

ON Semiconductor and are trademarks of Semiconductor Components Industries, LLC dba ON Semiconductor or its subsidiaries in the United States and/or other countries. ON Semiconductor reserves the right to make changes without further notice to any products herein. ON Semiconductor makes no warranty, representation or guarantee regarding the suitability of its products for any particular purpose, nor does ON Semiconductor assume any liability arising out of the application or use of any product or circuit, and specifically disclaims any and all liability, including without limitation special, consequential or incidental damages. ON Semiconductor does not convey any license under its patent rights nor the rights of others.

**onsemi**, **Onsemi**, and other names, marks, and brands are registered and/or common law trademarks of Semiconductor Components Industries, LLC dba "**onsemi**" or its affiliates and/or subsidiaries in the United States and/or other countries. **onsemi** owns the rights to a number of patents, trademarks, copyrights, trade secrets, and other intellectual property. A listing of **onsemi**'s product/patent coverage may be accessed at [www.onsemi.com/site/pdf/Patent-Marking.pdf](http://www.onsemi.com/site/pdf/Patent-Marking.pdf). **onsemi** reserves the right to make changes at any time to any products or information herein, without notice. The information herein is provided "as-is" and **onsemi** makes no warranty, representation or guarantee regarding the accuracy of the information, product features, availability, functionality, or suitability of its products for any particular purpose, nor does **onsemi** assume any liability arising out of the application or use of any product or circuit, and specifically disclaims any and all liability, including without limitation special, consequential or incidental damages. Buyer is responsible for its products and applications using **onsemi** products, including compliance with all laws, regulations and safety requirements or standards, regardless of any support or applications information provided by **onsemi**. "Typical" parameters which may be provided in **onsemi** data sheets and/or specifications can and do vary in different applications and actual performance may vary over time. All operating parameters, including "Typicals" must be validated for each customer application by customer's technical experts. **onsemi** does not convey any license under any of its intellectual property rights nor the rights of others. **onsemi** products are not designed, intended, or authorized for use as a critical component in life support systems or any FDA Class 3 medical devices or medical devices with a same or similar classification in a foreign jurisdiction or any devices intended for implantation in the human body. Should Buyer purchase or use **onsemi** products for any such unintended or unauthorized application, Buyer shall indemnify and hold **onsemi** and its officers, employees, subsidiaries, affiliates, and distributors harmless against all claims, costs, damages, and expenses, and reasonable attorney fees arising out of, directly or indirectly, any claim of personal injury or death associated with such unintended or unauthorized use, even if such claim alleges that **onsemi** was negligent regarding the design or manufacture of the part. **onsemi** is an Equal Opportunity/Affirmative Action Employer. This literature is subject to all applicable copyright laws and is not for resale in any manner.

## ADDITIONAL INFORMATION

### TECHNICAL PUBLICATIONS:

Technical Library: [www.onsemi.com/design/resources/technical-documentation](http://www.onsemi.com/design/resources/technical-documentation)  
onsemi Website: [www.onsemi.com](http://www.onsemi.com)

### ONLINE SUPPORT: [www.onsemi.com/support](http://www.onsemi.com/support)

For additional information, please contact your local Sales Representative at [www.onsemi.com/support/sales](http://www.onsemi.com/support/sales)