

# MOSFET - Power, Single N-Channel, Source Down, WDFN9

## 25 V, 0.85 mΩ, 264 A NTTFSS1D1N02P1E

### Features

- Advanced Source-Down Package Technology (3.3x3.3mm) with Excellent Thermal Conduction
- Ultra Low  $R_{DS(on)}$  to Improve System Efficiency
- Low  $Q_G$  and Capacitance to Minimize Driving and Switching Losses
- These Devices are Pb-Free, Halogen Free/BFR Free and are RoHS Compliant

### Typical Applications

- DC-DC Switching Applications
- ORing Applications
- Power Load Switch
- Battery Management and Protection

### MAXIMUM RATINGS ( $T_J = 25^\circ\text{C}$ unless otherwise noted)

Parameter		Symbol	Value	Unit	
Drain-to-Source Voltage		$V_{DS}$	25	V	
Gate-to-Source Voltage		$V_{GS}$	$\pm 16$	V	
Continuous Drain Current $R_{\theta JC}$ (Note 2)	Steady State	$T_C = 25^\circ\text{C}$	$I_D$	264	A
		$T_C = 85^\circ\text{C}$		189	
Power Dissipation $R_{\theta JC}$ (Note 2)	Steady State	$T_C = 25^\circ\text{C}$	$P_D$	89	W
Continuous Drain Current $R_{\theta JA}$ (Notes 1, 2)	Steady State	$T_A = 25^\circ\text{C}$	$I_D$	39	A
		$T_A = 85^\circ\text{C}$		28	
Power Dissipation $R_{\theta JA}$ (Notes 1, 2)	Steady State	$T_A = 25^\circ\text{C}$	$P_D$	2	W
Pulsed Drain Current	$T_A = 25^\circ\text{C}, t_p = 10 \mu\text{s}$	$I_{DM}$	900	A	
Single Pulse Drain-to-Source Avalanche Energy ( $I_{L(pk)} = 63 \text{ A}, L = 0.1 \text{ mH}$ )		$E_{AS}$	173	mJ	
Operating Junction and Storage Temperature Range		$T_J, T_{stg}$	-55 to +150	$^\circ\text{C}$	
Lead Temperature Soldering Reflow for Soldering Purposes (1/8" from case for 10 s)		$T_L$	260	$^\circ\text{C}$	

Stresses exceeding those listed in the Maximum Ratings table may damage the device. If any of these limits are exceeded, device functionality should not be assumed, damage may occur and reliability may be affected.

1. Surface-mounted on FR4 board using a 1 in<sup>2</sup> pad size, 1 oz Cu pad.
2. The entire application environment impacts the thermal resistance values shown, they are not constants and are valid for the particular conditions noted.

$V_{(BR)DSS}$	$R_{DS(ON)} \text{ MAX}$	$I_D \text{ MAX}$
25 V	0.85 mΩ @ 10 V	264 A
	1.05 mΩ @ 4.5 V	

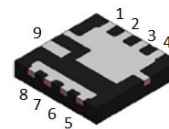
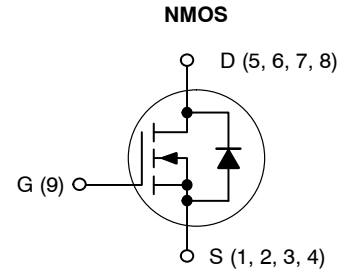

WDFN9  
CASE 511EB

### MARKING DIAGRAM

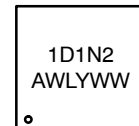

1D1N2 = Specific Device Code  
A = Assembly Location  
WL = Wafer Lot  
Y = Year  
WW = Work Week

### ORDERING INFORMATION

See detailed ordering and shipping information on page 5 of this data sheet.

# NTTFSS1D1N02P1E

## THERMAL RESISTANCE RATINGS

Parameter	Symbol	Max	Unit
Junction-to-Case – Steady State (Note 1)	$R_{\theta JC}$	1.4	$^{\circ}\text{C}/\text{W}$
Junction-to-Ambient – Steady State (Note 1, 2)	$R_{\theta JA}$	60	

## ELECTRICAL CHARACTERISTICS ( $T_J = 25^{\circ}\text{C}$ unless otherwise specified)

Parameter	Symbol	Test Condition	Min	Typ	Max	Unit
<b>OFF CHARACTERISTICS</b>						
Drain-to-Source Breakdown Voltage	$V_{(BR)DSS}$	$V_{GS} = 0\text{ V}, I_D = 250\ \mu\text{A}$	25			V
Drain-to-Source Breakdown Voltage Temperature Coefficient	$V_{(BR)DSS}/T_J$	$I_D = 250\ \mu\text{A}$ , ref to $25^{\circ}\text{C}$		12.8		$\text{mV}/^{\circ}\text{C}$
Zero Gate Voltage Drain Current	$I_{DSS}$	$V_{GS} = 0\text{ V}, V_{DS} = 20\text{ V}$	$T_J = 25^{\circ}\text{C}$		1.0	$\mu\text{A}$
			$T_J = 125^{\circ}\text{C}$		100	
Gate-to-Source Leakage Current	$I_{GSS}$	$V_{DS} = 0\text{ V}, V_{GS} = 16\text{ V}$			100	nA

## ON CHARACTERISTICS (Note 3)

Gate Threshold Voltage	$V_{GS(TH)}$	$V_{GS} = V_{DS}, I_D = 934\ \mu\text{A}$	1.2		2.0	V
Threshold Temperature Coefficient	$V_{GS(TH)}/T_J$	$I_D = 934\ \mu\text{A}$ , ref to $25^{\circ}\text{C}$		-4.9		$\text{mV}/^{\circ}\text{C}$
Drain-to-Source On Resistance	$R_{DS(on)}$	$V_{GS} = 10\text{ V}$	$I_D = 27\text{ A}$	0.70	0.85	$\text{m}\Omega$
		$V_{GS} = 4.5\text{ V}$	$I_D = 27\text{ A}$	0.83	1.05	
Forward Transconductance	$g_{FS}$	$V_{DS} = 3\text{ V}, I_D = 27\text{ A}$		146		S
Gate Resistance	$R_G$	$T_A = 25^{\circ}\text{C}$		0.8		$\Omega$

## CHARGES & CAPACITANCES

Input Capacitance	$C_{ISS}$	$V_{GS} = 0\text{ V}, V_{DS} = 13\text{ V}, f = 1\text{ MHz}$		4360		pF
Output Capacitance	$C_{OSS}$			1150		
Reverse Capacitance	$C_{RSS}$			80		
Total Gate Charge	$Q_{G(TOT)}$	$V_{GS} = 10\text{ V}, V_{DS} = 13\text{ V}; I_D = 27\text{ A}$		60		nC
Total Gate Charge	$Q_{G(TOT)}$	$V_{GS} = 4.5\text{ V}, V_{DS} = 13\text{ V}; I_D = 27\text{ A}$		26.3		
Threshold Gate Charge	$Q_{G(TH)}$			6.2		
Gate-to-Drain Charge	$Q_{GD}$			4.0		
Gate-to-Source Charge	$Q_{GS}$			10.8		

## SWITCHING CHARACTERISTICS, $V_{GS} = 10\text{ V}$ (Note 3)

Turn-On Delay Time	$t_{d(ON)}$	$V_{GS} = 10\text{ V}, V_{DD} = 13\text{ V}, I_D = 30\text{ A}, R_G = 3\ \Omega$		10.8		ns
Rise Time	$t_r$			3.4		
Turn-Off Delay Time	$t_{d(OFF)}$			34.7		
Fall Time	$t_f$			5.1		

## SOURCE-TO-DRAIN DIODE CHARACTERISTICS

Forward Diode Voltage	$V_{SD}$	$V_{GS} = 0\text{ V}, I_S = 27\text{ A}$	$T_J = 25^{\circ}\text{C}$	0.76	1.2	V
			$T_J = 125^{\circ}\text{C}$	0.63		
Reverse Recovery Time	$t_{RR}$	$V_{GS} = 0\text{ V}, di/dt = 100\text{ A}/\mu\text{s}, I_S = 27\text{ A}$		45		ns
Reverse Recovery Charge	$Q_{RR}$			40		nC

Product parametric performance is indicated in the Electrical Characteristics for the listed test conditions, unless otherwise noted. Product performance may not be indicated by the Electrical Characteristics if operated under different conditions.

3. Switching characteristics are independent of operating junction temperatures.

TYPICAL CHARACTERISTICS

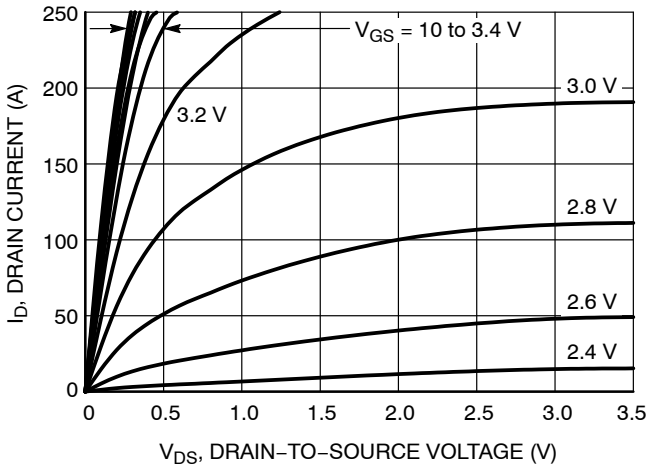

Figure 1. On-Region Characteristics

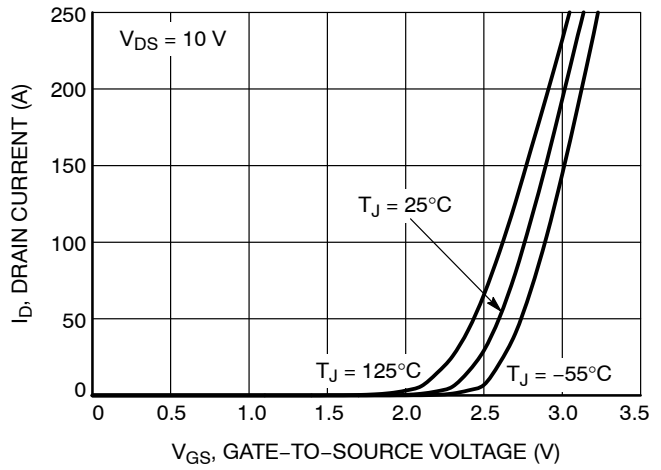

Figure 2. Transfer Characteristics

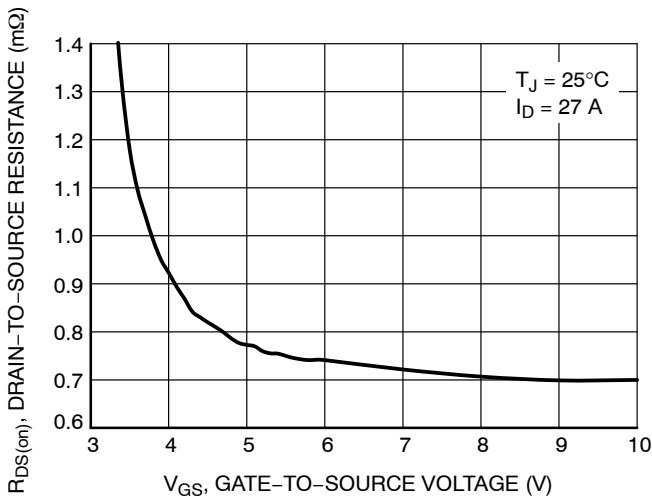

Figure 3. On-Resistance vs. Gate-to-Source Voltage

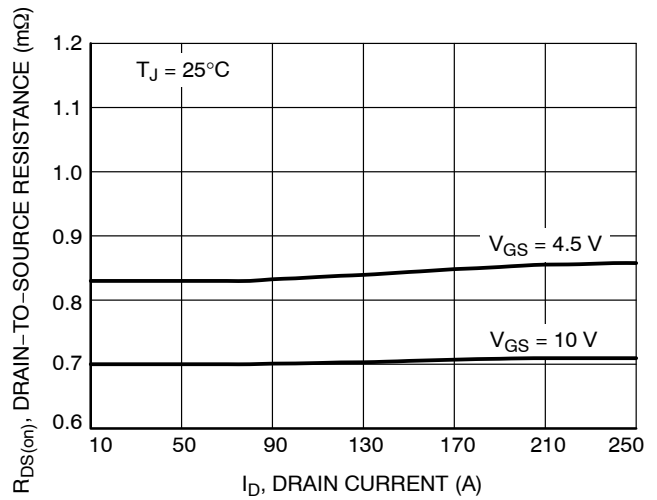

Figure 4. On-Resistance vs. Drain Current

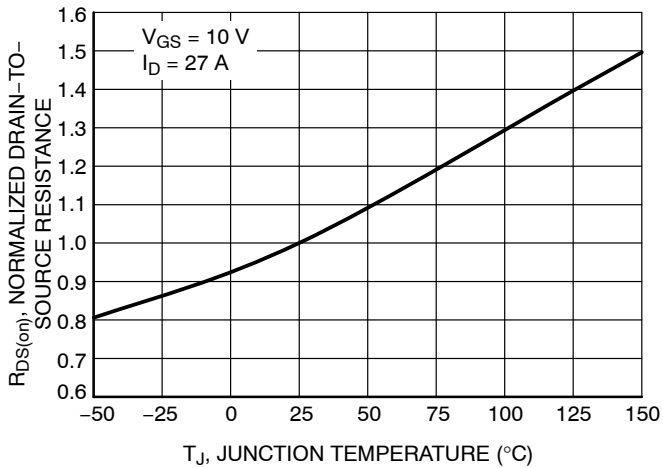

Figure 5. On-Resistance Variation with Temperature

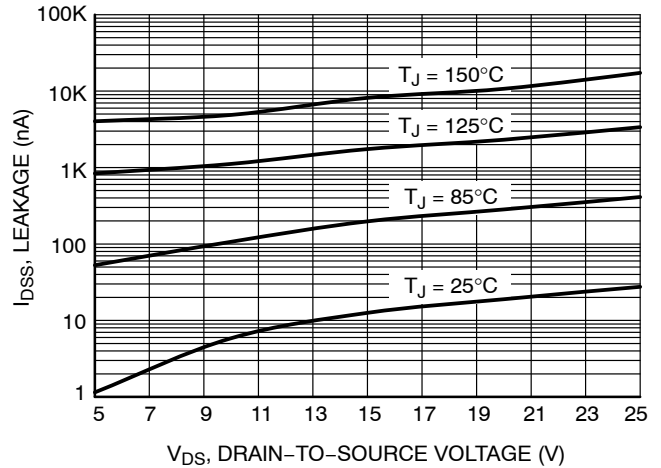

Figure 6. Drain-to-Source Leakage Current vs. Voltage

# NTTFSS1D1N02P1E

## TYPICAL CHARACTERISTICS

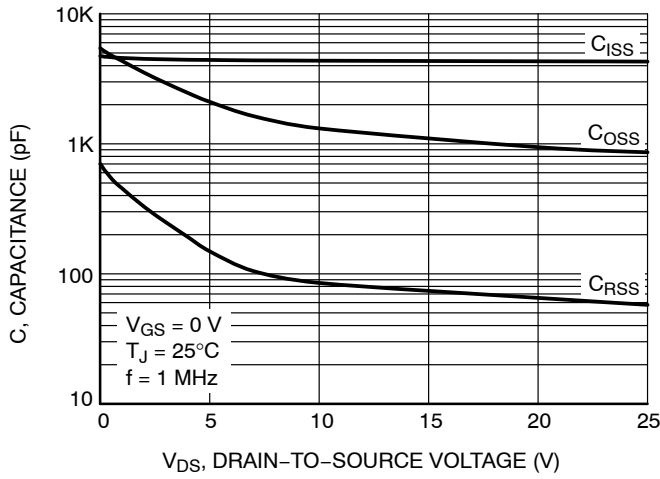

Figure 7. Capacitance Variation

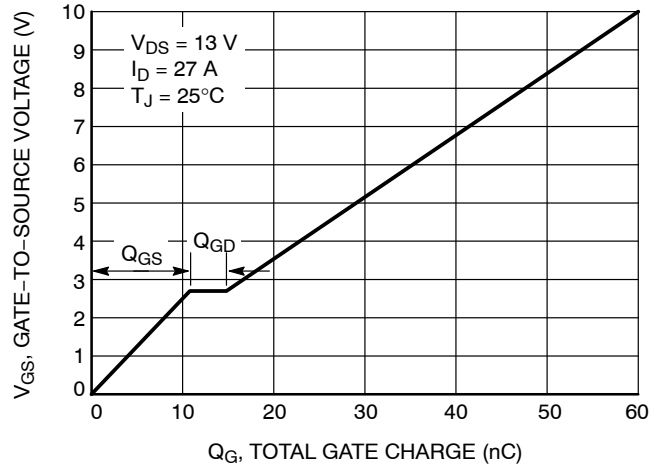

Figure 8. Gate-to-Source Voltage vs. Total Charge

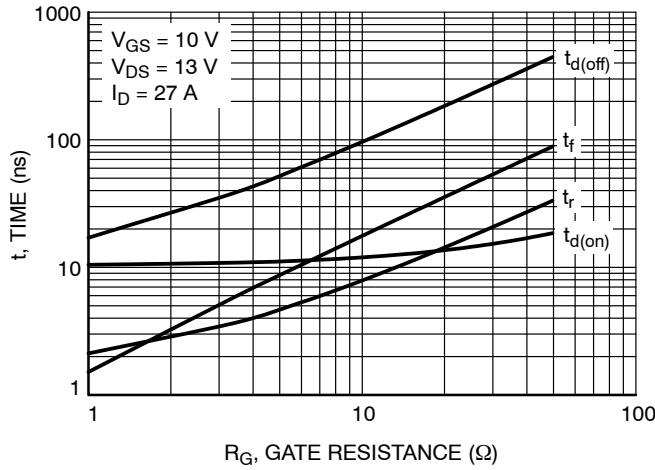

Figure 9. Resistive Switching Time Variation vs. Gate Resistance

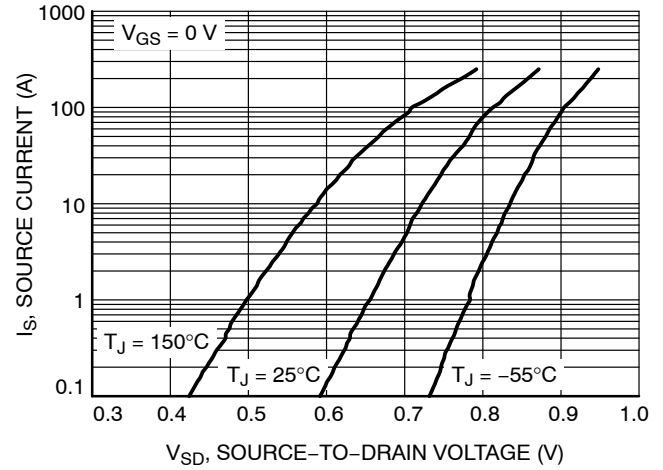

Figure 10. Diode Forward Voltage vs. Current

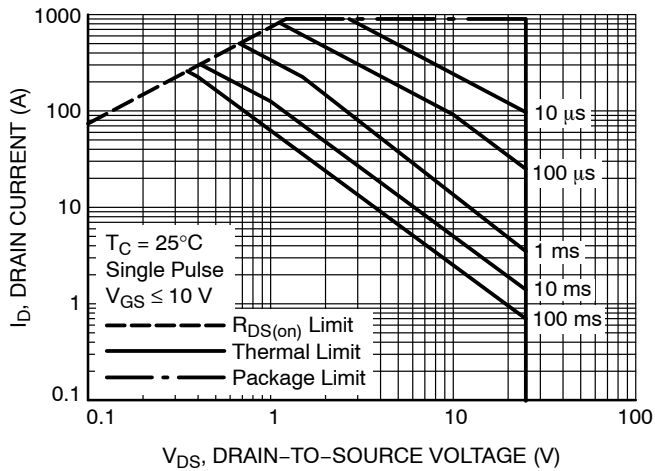

Figure 11. Maximum Rated Forward Biased Safe Operating Area

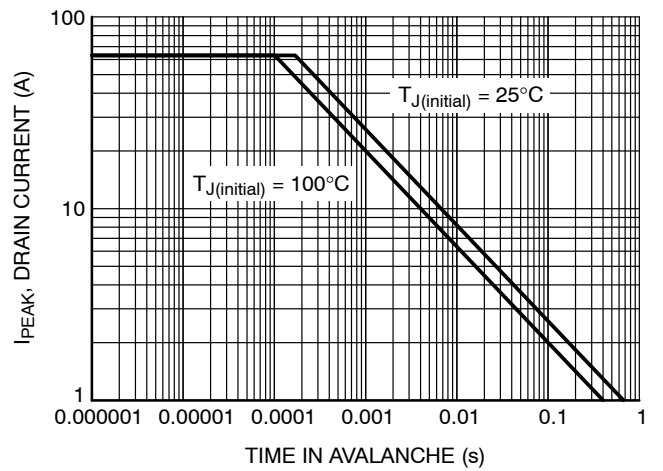

Figure 12. Maximum Drain Current vs. Time in Avalanche

# NTTFSS1D1N02P1E

## TYPICAL CHARACTERISTICS

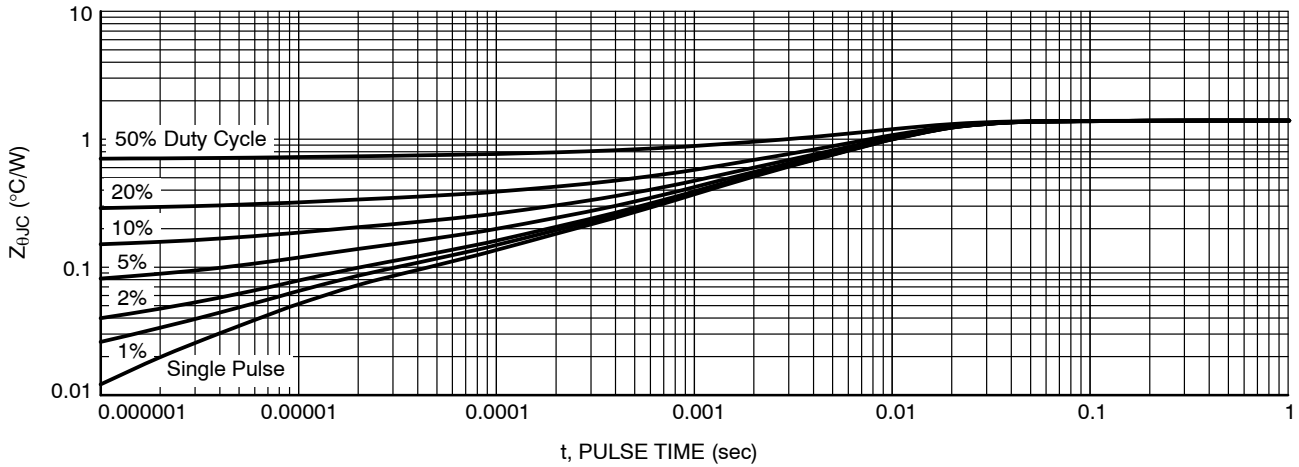

Figure 13. Junction-to-Case Transient Thermal Response

### ORDERING INFORMATION

Device	Marking	Package	Shipping <sup>†</sup>
NTTFSS1D1N02P1E	1D1N2	WDFN9 (Pb-Free)	3000 / Tape & Reel

<sup>†</sup>For information on tape and reel specifications, including part orientation and tape sizes, please refer to our Tape and Reel Packaging Specifications Brochure, BRD8011/D.

# MECHANICAL CASE OUTLINE

## PACKAGE DIMENSIONS

ON Semiconductor®

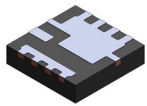

### WDFN9 3.3x3.3, 0.65P CASE 511EB ISSUE B

DATE 21 JUL 2021

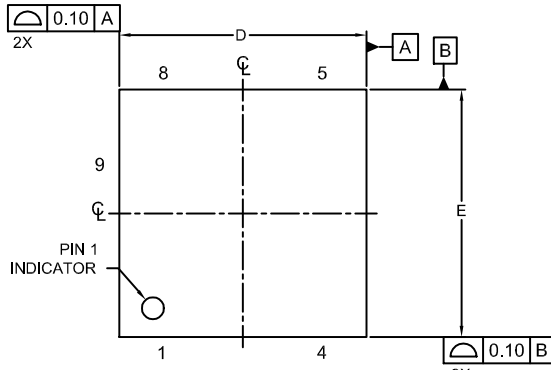

TOP VIEW

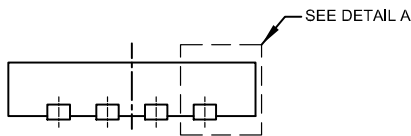

FRONT VIEW

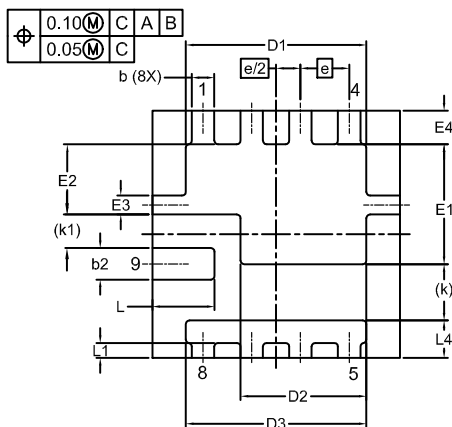

BOTTOM VIEW

NOTES:

1. CONTROLLING DIMENSION: MILLIMETERS
2. COPLANARITY APPLIES TO THE EXPOSED PADS AS WELL AS THE TERMINALS.
3. DIMENSIONS D1, D2, E1 AND E2 DO NOT INCLUDE MOLD FLASH.
4. SEATING PLANE IS DEFINED BY THE TERMINALS. "A1" IS DEFINED AS THE DISTANCE FROM THE SEATING PLANE TO THE LOWEST POINT OF THE PACKAGE BODY.

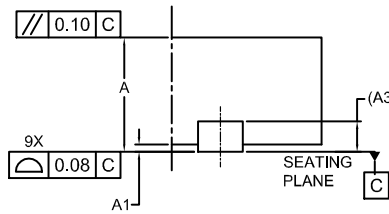

DETAIL A  
SCALE: 2:1

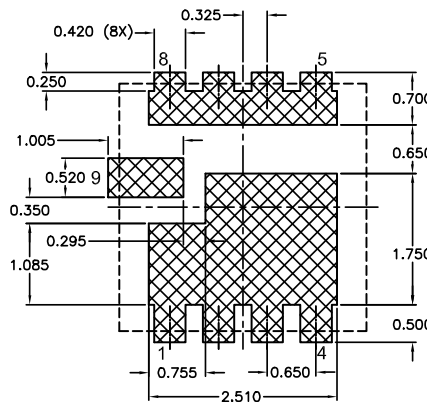

LAND PATTERN  
RECOMMENDATION

\*FOR ADDITIONAL INFORMATION ON OUR PB-FREE STRATEGY AND SOLDERING DETAILS, PLEASE DOWNLOAD THE ON SEMICONDUCTOR SOLDERING AND MOUNTING TECHNIQUES REFERENCE MANUAL, SOLDERRM/D.

UNIT IN MILLIMETER			
DIM	MIN	NOM	MAX
A	0.70	0.75	0.80
A1	0.00	0.02	0.05
A3	0.20 REF		
b	0.25	0.30	0.35
b2	0.37	0.42	0.47
D	3.20	3.30	3.40
D1	2.31	2.41	2.51
D2	1.58	1.68	1.78
D3	2.31	2.41	2.51
E	3.20	3.30	3.40
E1	1.50	1.60	1.70
E2	0.84	0.94	1.04
E3	0.20	0.25	0.30
E4	0.35	0.45	0.55
e	0.650 BSC		
e/2	0.325 BSC		
k	0.75 REF		
k1	0.45 REF		
L	0.73	0.83	0.93
L1	0.10	0.20	0.30
L4	0.40	0.50	0.60

### GENERIC MARKING DIAGRAM\*



XXXX = Specific Device Code  
 A = Assembly Location  
 WL = Wafer Lot  
 Y = Year  
 WW = Work Week

\*This information is generic. Please refer to device data sheet for actual part marking. Pb-Free indicator, "G" or microdot "•", may or may not be present. Some products may not follow the Generic Marking.

<b>DOCUMENT NUMBER:</b>	<b>98AON08290H</b>	Electronic versions are uncontrolled except when accessed directly from the Document Repository. Printed versions are uncontrolled except when stamped "CONTROLLED COPY" in red.
<b>DESCRIPTION:</b>	<b>WDFN9 3.3x3.3, 0.65P</b>	<b>PAGE 1 OF 1</b>

ON Semiconductor and ON are trademarks of Semiconductor Components Industries, LLC dba ON Semiconductor or its subsidiaries in the United States and/or other countries. ON Semiconductor reserves the right to make changes without further notice to any products herein. ON Semiconductor makes no warranty, representation or guarantee regarding the suitability of its products for any particular purpose, nor does ON Semiconductor assume any liability arising out of the application or use of any product or circuit, and specifically disclaims any and all liability, including without limitation special, consequential or incidental damages. ON Semiconductor does not convey any license under its patent rights nor the rights of others.

**onsemi**, **Onsemi**, and other names, marks, and brands are registered and/or common law trademarks of Semiconductor Components Industries, LLC dba "**onsemi**" or its affiliates and/or subsidiaries in the United States and/or other countries. **onsemi** owns the rights to a number of patents, trademarks, copyrights, trade secrets, and other intellectual property. A listing of **onsemi**'s product/patent coverage may be accessed at [www.onsemi.com/site/pdf/Patent-Marking.pdf](http://www.onsemi.com/site/pdf/Patent-Marking.pdf). **onsemi** reserves the right to make changes at any time to any products or information herein, without notice. The information herein is provided "as-is" and **onsemi** makes no warranty, representation or guarantee regarding the accuracy of the information, product features, availability, functionality, or suitability of its products for any particular purpose, nor does **onsemi** assume any liability arising out of the application or use of any product or circuit, and specifically disclaims any and all liability, including without limitation special, consequential or incidental damages. Buyer is responsible for its products and applications using **onsemi** products, including compliance with all laws, regulations and safety requirements or standards, regardless of any support or applications information provided by **onsemi**. "Typical" parameters which may be provided in **onsemi** data sheets and/or specifications can and do vary in different applications and actual performance may vary over time. All operating parameters, including "Typicals" must be validated for each customer application by customer's technical experts. **onsemi** does not convey any license under any of its intellectual property rights nor the rights of others. **onsemi** products are not designed, intended, or authorized for use as a critical component in life support systems or any FDA Class 3 medical devices or medical devices with a same or similar classification in a foreign jurisdiction or any devices intended for implantation in the human body. Should Buyer purchase or use **onsemi** products for any such unintended or unauthorized application, Buyer shall indemnify and hold **onsemi** and its officers, employees, subsidiaries, affiliates, and distributors harmless against all claims, costs, damages, and expenses, and reasonable attorney fees arising out of, directly or indirectly, any claim of personal injury or death associated with such unintended or unauthorized use, even if such claim alleges that **onsemi** was negligent regarding the design or manufacture of the part. **onsemi** is an Equal Opportunity/Affirmative Action Employer. This literature is subject to all applicable copyright laws and is not for resale in any manner.

## ADDITIONAL INFORMATION

### TECHNICAL PUBLICATIONS:

Technical Library: [www.onsemi.com/design/resources/technical-documentation](http://www.onsemi.com/design/resources/technical-documentation)  
onsemi Website: [www.onsemi.com](http://www.onsemi.com)

### ONLINE SUPPORT: [www.onsemi.com/support](http://www.onsemi.com/support)

For additional information, please contact your local Sales Representative at [www.onsemi.com/support/sales](http://www.onsemi.com/support/sales)