

# MOSFET - Power, Single N-Channel, TDFNW8

## 60 V, 0.72 mΩ, 464 A

### NTMTS0D7N06C

#### Features

- Small Footprint (8x8 mm) for Compact Design
- Low  $R_{DS(on)}$  to Minimize Conduction Losses
- Low  $Q_G$  and Capacitance to Minimize Driver Losses
- These Devices are Pb-Free, Halogen Free/BFR Free and are RoHS Compliant

#### Typical Applications

- Power Tools, Battery Operated Vacuums
- UAV/Drones, Material Handling
- BMS/Storage, Home Automation

#### MAXIMUM RATINGS ( $T_J = 25^\circ\text{C}$ unless otherwise noted)

Parameter		Symbol	Value	Unit	
Drain-to-Source Voltage		$V_{DSS}$	60	V	
Gate-to-Source Voltage		$V_{GS}$	$\pm 20$	V	
Continuous Drain Current $R_{\theta JC}$ (Note 2)	Steady State	$T_C = 25^\circ\text{C}$	$I_D$	464	A
		$T_C = 100^\circ\text{C}$		328.1	
Power Dissipation $R_{\theta JC}$ (Note 2)		$T_C = 25^\circ\text{C}$	$P_D$	294.6	W
		$T_C = 100^\circ\text{C}$		147.3	
Continuous Drain Current $R_{\theta JA}$ (Notes 1, 2)	Steady State	$T_A = 25^\circ\text{C}$	$I_D$	60.5	A
		$T_A = 100^\circ\text{C}$		42.7	
Power Dissipation $R_{\theta JA}$ (Notes 1, 2)		$T_A = 25^\circ\text{C}$	$P_D$	5.0	W
		$T_A = 100^\circ\text{C}$		2.5	
Pulsed Drain Current	$T_A = 25^\circ\text{C}, t_p = 10 \mu\text{s}$	$I_{DM}$	900	A	
Operating Junction and Storage Temperature Range		$T_J, T_{stg}$	-55 to +175	$^\circ\text{C}$	
Source Current (Body Diode)		$I_S$	245.5	A	
Single Pulse Drain-to-Source Avalanche Energy ( $I_{L(pk)} = 40 \text{ A}$ )		$E_{AS}$	1754	mJ	
Lead Temperature for Soldering Purposes (1/8" from case for 10 s)		$T_L$	260	$^\circ\text{C}$	

Stresses exceeding those listed in the Maximum Ratings table may damage the device. If any of these limits are exceeded, device functionality should not be assumed, damage may occur and reliability may be affected.

#### THERMAL RESISTANCE MAXIMUM RATINGS

Parameter	Symbol	Value	Unit
Junction-to-Case - Steady State	$R_{\theta JC}$	0.5	$^\circ\text{C}/\text{W}$
Junction-to-Ambient - Steady State (Note 1)	$R_{\theta JA}$	30	

1. Surface-mounted on FR4 board using a 1 in<sup>2</sup> pad size, 2 oz. Cu pad.
2. The entire application environment impacts the thermal resistance values shown, they are not constants and are only valid for the particular conditions noted.

$V_{(BR)DSS}$	$R_{DS(ON)} \text{ MAX}$	$I_D \text{ MAX}$
60 V	0.72 mΩ @ 10 V	464 A

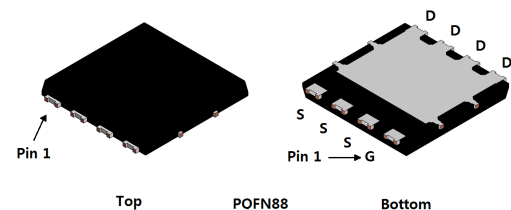
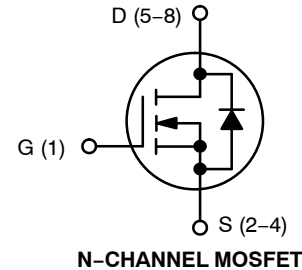

TDFNW8  
CASE 507AP

#### MARKING DIAGRAM

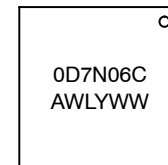

- A = Assembly Location
- WL = 2-digit Wafer Lot Code
- Y = Year Code
- WW = Work Week Code

#### ORDERING INFORMATION

See detailed ordering, marking and shipping information in the package dimensions section on page 5 of this data sheet.

# NTMTS0D7N06C

## ELECTRICAL CHARACTERISTICS ( $T_J = 25^\circ\text{C}$ unless otherwise specified)

Parameter	Symbol	Test Condition	Min	Typ	Max	Unit
<b>OFF CHARACTERISTICS</b>						
Drain-to-Source Breakdown Voltage	$V_{(BR)DSS}$	$V_{GS} = 0\text{ V}, I_D = 250\ \mu\text{A}$	60			V
Drain-to-Source Breakdown Voltage Temperature Coefficient	$V_{(BR)DSS}/T_J$	$I_D = 250\ \mu\text{A}$ , ref to $25^\circ\text{C}$		24.7		mV/ $^\circ\text{C}$
Zero Gate Voltage Drain Current	$I_{DSS}$	$V_{GS} = 0\text{ V}, V_{DS} = 60\text{ V}$	$T_J = 25^\circ\text{C}$		10	$\mu\text{A}$
			$T_J = 125^\circ\text{C}$		250	
Gate-to-Source Leakage Current	$I_{GSS}$	$V_{DS} = 0\text{ V}, V_{GS} = 20\text{ V}$			100	nA

### ON CHARACTERISTICS (Note 3)

Gate Threshold Voltage	$V_{GS(TH)}$	$V_{GS} = V_{DS}, I_D = 250\ \mu\text{A}$	2.0		4.0	V
Negative Threshold Temperature Coefficient	$V_{GS(TH)}/T_J$	$I_D = 250\ \mu\text{A}$ , ref to $25^\circ\text{C}$		-7.93		mV/ $^\circ\text{C}$
Drain-to-Source On Resistance	$R_{DS(on)}$	$V_{GS} = 10\text{ V}, I_D = 50\text{ A}$		0.55	0.72	m $\Omega$
Forward Transconductance	$g_{FS}$	$V_{DS} = 5\text{ V}, I_D = 50\text{ A}$		250		S
Gate Resistance	$R_G$	$T_A = 25^\circ\text{C}$		1.0		$\Omega$

### CHARGES, CAPACITANCES & GATE RESISTANCE

Input Capacitance	$C_{ISS}$	$V_{GS} = 0\text{ V}, f = 1\text{ MHz}, V_{DS} = 30\text{ V}$		11535		$\text{pF}$
Output Capacitance	$C_{OSS}$			8010		
Reverse Transfer Capacitance	$C_{RSS}$			174		
Threshold Gate Charge	$Q_{G(TH)}$	$V_{GS} = 10\text{ V}, V_{DS} = 30\text{ V}; I_D = 50\text{ A}$		25.7		$\text{nC}$
Gate-to-Source Charge	$Q_{GS}$			40.0		
Gate-to-Drain Charge	$Q_{GD}$			20.7		
Total Gate Charge	$Q_{G(TOT)}$			152		
Voltage Plateau	$V_{GP}$			3.71		
Total Gate Charge	$Q_{G(TOT)}$	$V_{GS} = 4.5\text{ V}, V_{DS} = 30\text{ V}; I_D = 50\text{ A}$		72		nC

### SWITCHING CHARACTERISTICS (Note 4)

Turn-On Delay Time	$t_{d(ON)}$	$V_{GS} = 10\text{ V}, V_{DS} = 30\text{ V}, I_D = 50\text{ A}, R_G = 6\ \Omega$		39.7		$\text{ns}$
Rise Time	$t_r$			29.3		
Turn-Off Delay Time	$t_{d(OFF)}$			127		
Fall Time	$t_f$			42.6		

### DRAIN-SOURCE DIODE CHARACTERISTICS

Forward Diode Voltage	$V_{SD}$	$V_{GS} = 0\text{ V}, I_S = 50\text{ A}$	$T_J = 25^\circ\text{C}$		0.72	1.2	V
			$T_J = 125^\circ\text{C}$		0.59		
Reverse Recovery Time	$t_{RR}$	$V_{GS} = 0\text{ V}, dI_S/dt = 100\text{ A}/\mu\text{s}, I_S = 50\text{ A}$		120		$\text{ns}$	
Charge Time	$t_a$			60			
Discharge Time	$t_b$			60			
Reverse Recovery Charge	$Q_{RR}$			324			nC

Product parametric performance is indicated in the Electrical Characteristics for the listed test conditions, unless otherwise noted. Product performance may not be indicated by the Electrical Characteristics if operated under different conditions.

3. Pulse Test: pulse width  $\leq 300\ \mu\text{s}$ , duty cycle  $\leq 2\%$ .

4. Switching characteristics are independent of operating junction temperatures.

# NTMTS0D7N06C

## TYPICAL CHARACTERISTICS

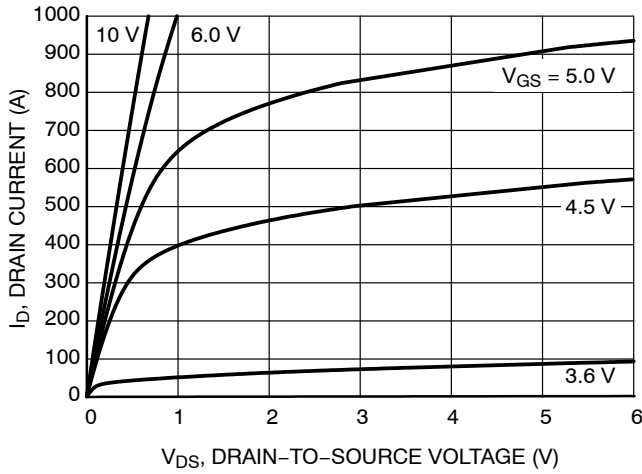

Figure 1. On-Region Characteristics

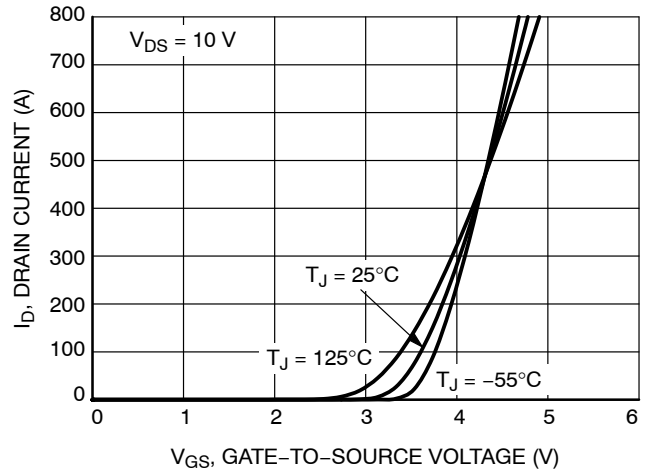

Figure 2. Transfer Characteristics

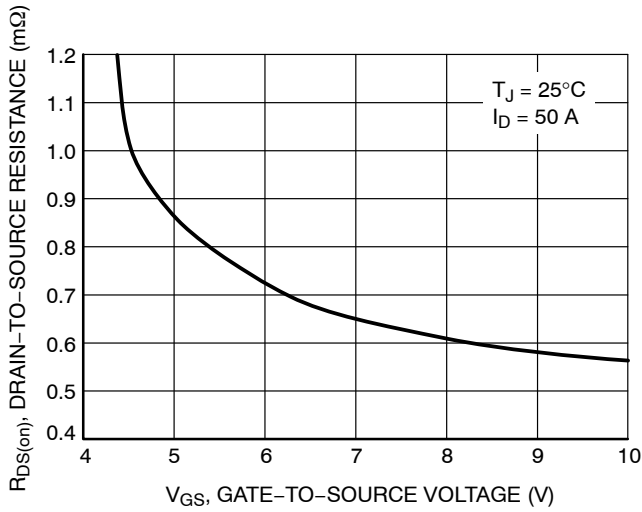

Figure 3. On-Resistance vs. Gate-to-Source Voltage

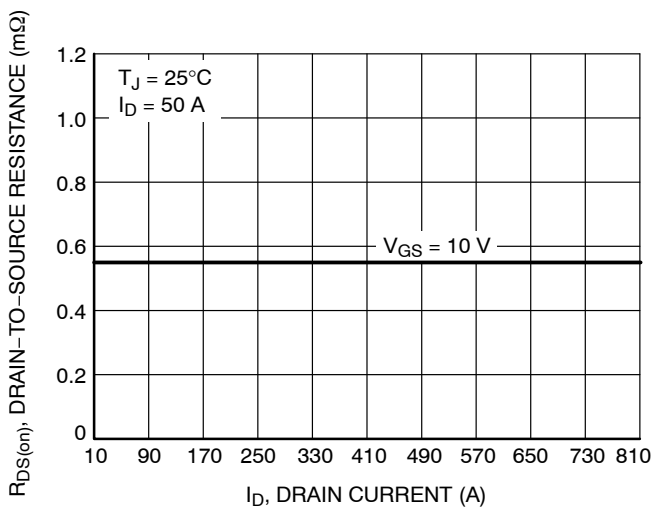

Figure 4. On-Resistance vs. Drain Current and Gate Voltage

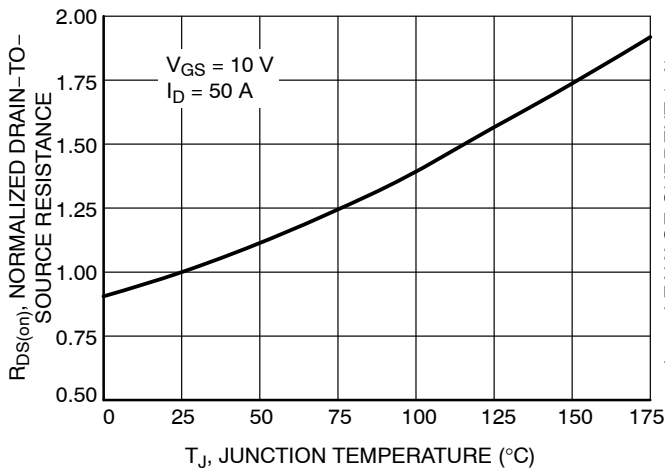

Figure 5. On-Resistance Variation with Temperature

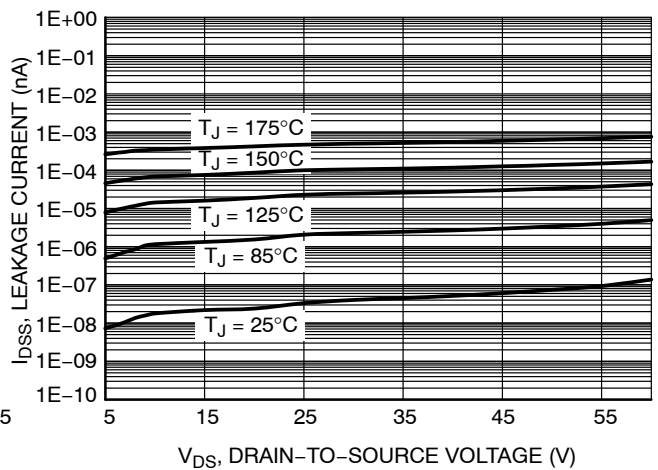

Figure 6. Drain-to-Source Leakage Current vs. Voltage

# NTMTS0D7N06C

## TYPICAL CHARACTERISTICS

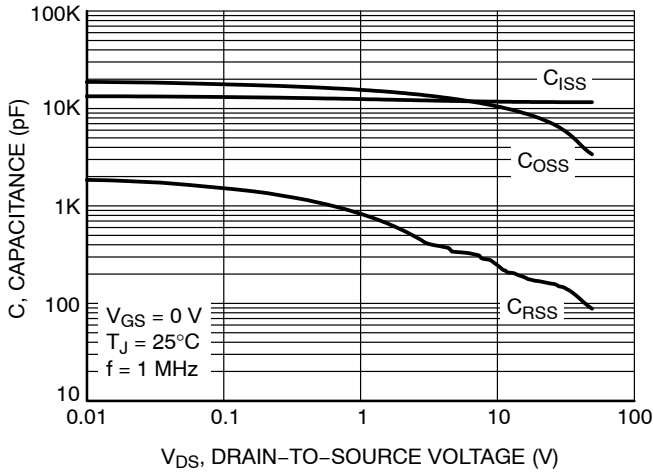

Figure 7. Capacitance Variation

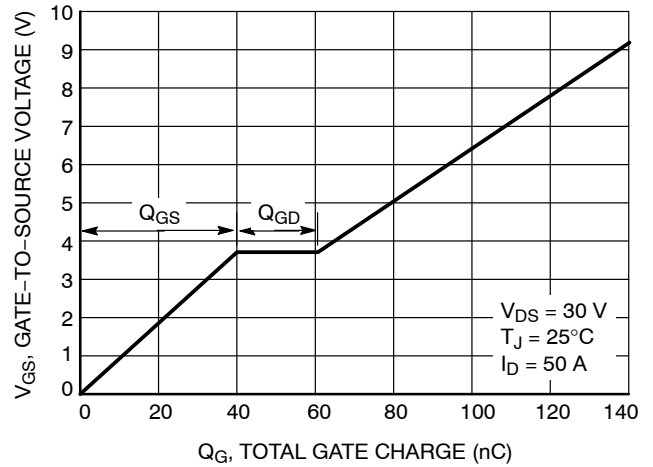

Figure 8. Gate-to-Source Voltage vs. Total Charge

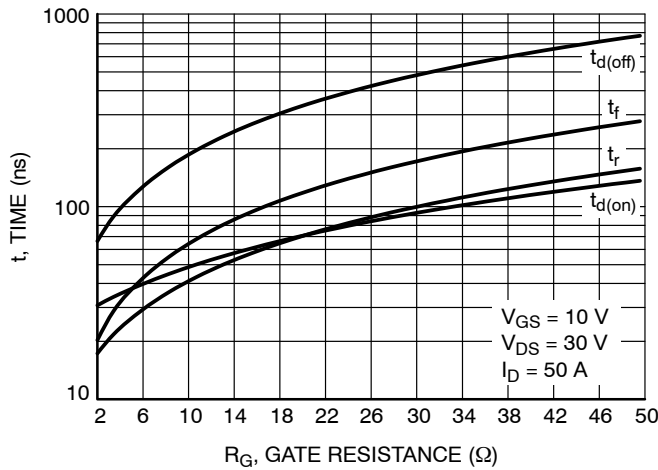

Figure 9. Resistive Switching Time Variation vs. Gate Resistance

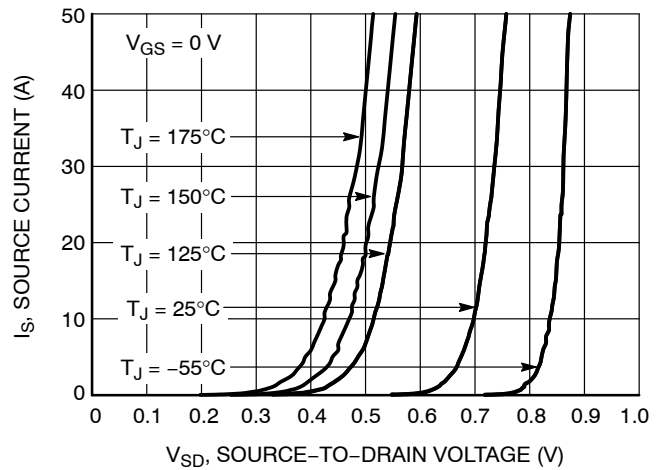

Figure 10. Diode Forward Voltage vs. Current

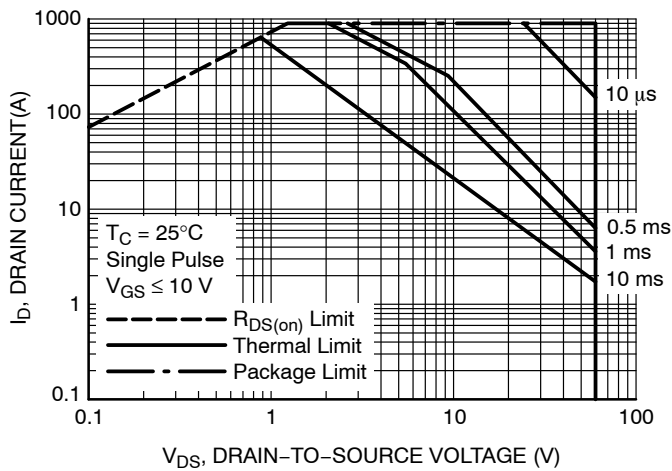

Figure 11. Maximum Rated Forward Biased Safe Operating Area

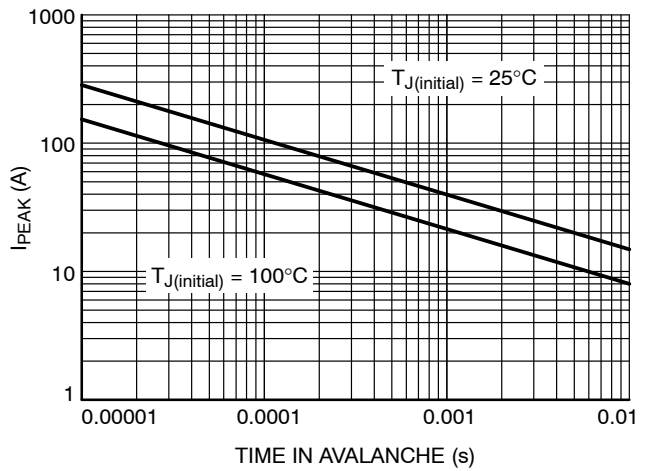

Figure 12. Maximum Drain Current vs. Time in Avalanche

# NTMTS0D7N06C

## TYPICAL CHARACTERISTICS

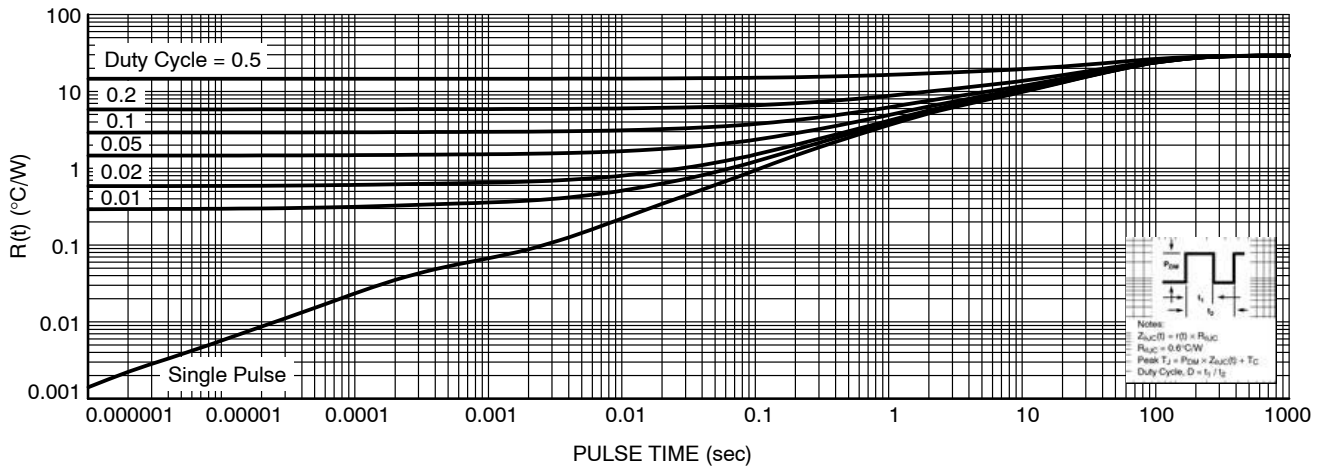

Figure 13. Thermal Characteristics

### DEVICE ORDERING INFORMATION

Device	Marking	Package	Shipping†
NTMTS0D7N06CTXG	0D7N06C	TDFNW8 (Pb-Free)	3000 / Tape & Reel

†For information on tape and reel specifications, including part orientation and tape sizes, please refer to our Tape and Reel Packaging Specifications Brochure, BRD8011/D.

# MECHANICAL CASE OUTLINE

## PACKAGE DIMENSIONS

ON Semiconductor®

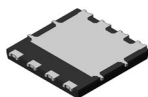

### TDFNW8 8.3x8.4, 2.0P, SINGLE COOL CASE 507AP ISSUE D

DATE 29 MAR 2021

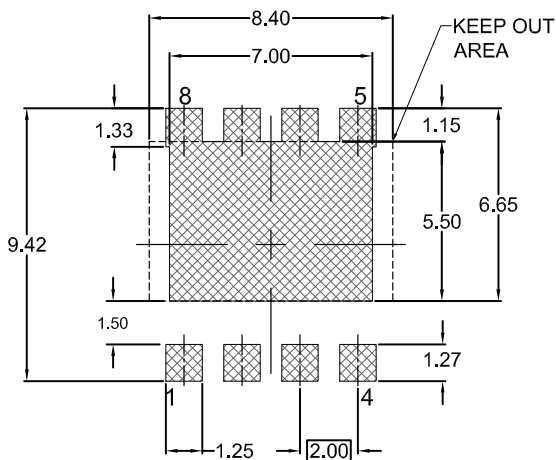
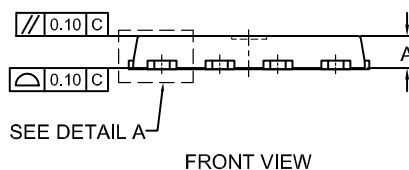
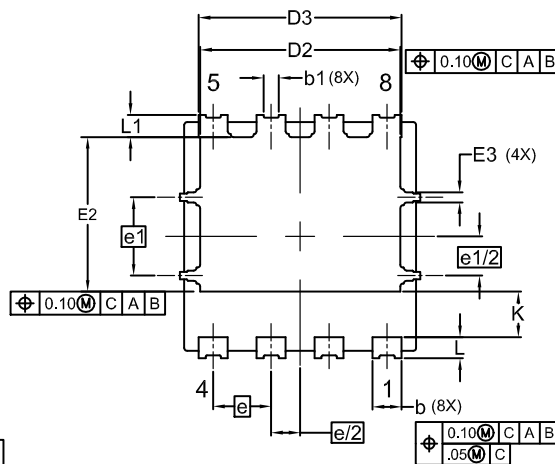
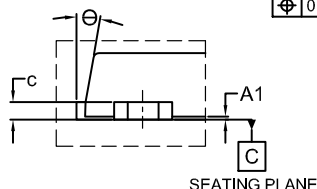
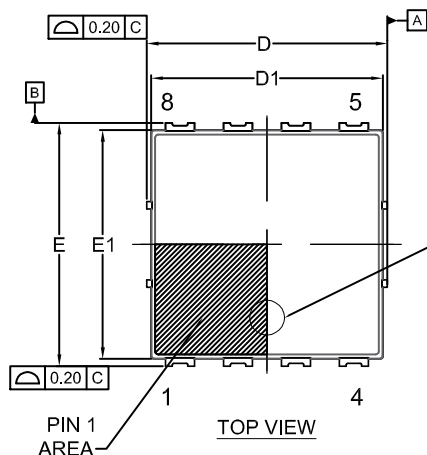

#### RECOMMENDED LAND PATTERN\*

\*FOR ADDITIONAL INFORMATION ON OUR PB-FREE STRATEGY AND SOLDERING DETAILS, PLEASE DOWNLOAD THE ON SEMICONDUCTOR SOLDERING AND MOUNTING TECHNIQUES REFERENCE MANUAL, SOLDERM/D.

#### GENERIC MARKING DIAGRAM\*

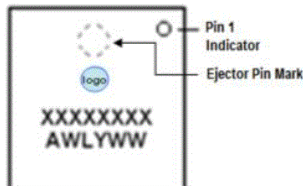

XXXX = Specific Device Code  
A = Assembly Location  
WL = Wafer Lot Code  
Y = Year Code  
WW = Work Week Code

\*This information is generic. Please refer to device data sheet for actual part marking. Pb-Free indicator, "G" or microdot "▪", may or may not be present. Some products may not follow the Generic Marking.

#### NOTES:

1. DIMENSIONING AND TOLERANCING PER ASME Y14.5M, 2009.
2. CONTROLLING DIMENSION: MILLIMETERS
3. COPLANARITY APPLIES TO THE EXPOSED PADS AS WELL AS THE TERMINALS.
4. DIMENSIONS D1 AND E1 DO NOT INCLUDE MOLD FLASH, PROTRUSIONS, OR GATE BURRS.
5. SEATING PLANE IS DEFINED BY THE TERMINALS. "A1" IS DEFINED AS THE DISTANCE FROM THE SEATING PLANE TO THE LOWEST POINT ON THE PACKAGE BODY.

DIM	MILLIMETERS		
	MIN.	NOM.	MAX.
A	1.00	1.10	1.20
A1	0.00	—	0.05
b	0.90	1.00	1.10
b1	0.35	0.45	0.55
c	0.23	0.28	0.33
D	8.20	8.30	8.40
D1	7.90	8.00	8.10
D2	6.80	6.90	7.00
D3	6.90	7.00	7.10
E	8.30	8.40	8.50
E1	7.80	7.90	8.00
E2	5.24	5.34	5.44
E3	0.25	0.35	0.45
e	2.00 BSC		
e/2	1.00 BSC		
e1	2.70 BSC		
e1/2	1.35 BSC		
K	1.50	1.57	1.70
L	0.64	0.74	0.84
L1	0.67	0.77	0.87
Θ	0°	—	12°

<b>DOCUMENT NUMBER:</b>	<b>98AON80534G</b>	Electronic versions are uncontrolled except when accessed directly from the Document Repository. Printed versions are uncontrolled except when stamped "CONTROLLED COPY" in red.
<b>DESCRIPTION:</b>	<b>TDFNW8 8.3x8.4, 2.0P, SINGLE COOL</b>	<b>PAGE 1 OF 1</b>

ON Semiconductor and ON are trademarks of Semiconductor Components Industries, LLC dba ON Semiconductor or its subsidiaries in the United States and/or other countries. ON Semiconductor reserves the right to make changes without further notice to any products herein. ON Semiconductor makes no warranty, representation or guarantee regarding the suitability of its products for any particular purpose, nor does ON Semiconductor assume any liability arising out of the application or use of any product or circuit, and specifically disclaims any and all liability, including without limitation special, consequential or incidental damages. ON Semiconductor does not convey any license under its patent rights nor the rights of others.

**onsemi**, **Onsemi**, and other names, marks, and brands are registered and/or common law trademarks of Semiconductor Components Industries, LLC dba "**onsemi**" or its affiliates and/or subsidiaries in the United States and/or other countries. **onsemi** owns the rights to a number of patents, trademarks, copyrights, trade secrets, and other intellectual property. A listing of **onsemi**'s product/patent coverage may be accessed at [www.onsemi.com/site/pdf/Patent-Marking.pdf](http://www.onsemi.com/site/pdf/Patent-Marking.pdf). **onsemi** reserves the right to make changes at any time to any products or information herein, without notice. The information herein is provided "as-is" and **onsemi** makes no warranty, representation or guarantee regarding the accuracy of the information, product features, availability, functionality, or suitability of its products for any particular purpose, nor does **onsemi** assume any liability arising out of the application or use of any product or circuit, and specifically disclaims any and all liability, including without limitation special, consequential or incidental damages. Buyer is responsible for its products and applications using **onsemi** products, including compliance with all laws, regulations and safety requirements or standards, regardless of any support or applications information provided by **onsemi**. "Typical" parameters which may be provided in **onsemi** data sheets and/or specifications can and do vary in different applications and actual performance may vary over time. All operating parameters, including "Typicals" must be validated for each customer application by customer's technical experts. **onsemi** does not convey any license under any of its intellectual property rights nor the rights of others. **onsemi** products are not designed, intended, or authorized for use as a critical component in life support systems or any FDA Class 3 medical devices or medical devices with a same or similar classification in a foreign jurisdiction or any devices intended for implantation in the human body. Should Buyer purchase or use **onsemi** products for any such unintended or unauthorized application, Buyer shall indemnify and hold **onsemi** and its officers, employees, subsidiaries, affiliates, and distributors harmless against all claims, costs, damages, and expenses, and reasonable attorney fees arising out of, directly or indirectly, any claim of personal injury or death associated with such unintended or unauthorized use, even if such claim alleges that **onsemi** was negligent regarding the design or manufacture of the part. **onsemi** is an Equal Opportunity/Affirmative Action Employer. This literature is subject to all applicable copyright laws and is not for resale in any manner.

---

## ADDITIONAL INFORMATION

### TECHNICAL PUBLICATIONS:

Technical Library: [www.onsemi.com/design/resources/technical-documentation](http://www.onsemi.com/design/resources/technical-documentation)  
onsemi Website: [www.onsemi.com](http://www.onsemi.com)

### ONLINE SUPPORT: [www.onsemi.com/support](http://www.onsemi.com/support)

For additional information, please contact your local Sales Representative at [www.onsemi.com/support/sales](http://www.onsemi.com/support/sales)

