

MOSFET - Power, Single N-Channel, DUAL COOL[®]

80 V, 10 mΩ, 61 A

NTMFSC011N08M7

Features

- DUAL COOL Top Side Cooling PQFN Package
- Max $r_{DS(on)}$ = 10 mΩ at $V_{GS} = 10$ V, $I_D = 10$ A
- High Performance Technology for Extremely Low $r_{DS(on)}$
- 100% UIL Tested
- These Devices are Pb-Free, Halogen Free/BFR Free and are RoHS Compliant

MAXIMUM RATINGS ($T_J = 25^\circ\text{C}$ unless otherwise noted)

Parameter		Symbol	Value	Unit	
Drain-to-Source Voltage		V_{DSS}	80	V	
Gate-to-Source Voltage		V_{GS}	±20	V	
Continuous Drain Current $R_{\theta JC}$ (Notes 1, 3)	Steady State	$T_C = 25^\circ\text{C}$	I_D	61	A
		$T_C = 100^\circ\text{C}$		38.6	
Power Dissipation $R_{\theta JC}$ (Note 1)	Steady State	$T_C = 25^\circ\text{C}$	P_D	78.1	W
		$T_C = 100^\circ\text{C}$		31.2	
Continuous Drain Current $R_{\theta JA}$ (Notes 1, 2, 3)	Steady State	$T_A = 25^\circ\text{C}$	I_D	12.5	A
		$T_A = 100^\circ\text{C}$		7.9	
Power Dissipation $R_{\theta JA}$ (Notes 1, 2)	Steady State	$T_A = 25^\circ\text{C}$	P_D	3.3	W
		$T_A = 100^\circ\text{C}$		1.3	
Pulsed Drain Current	$T_A = 25^\circ\text{C}$, $t_p = 10 \mu\text{s}$	I_{DM}	180	A	
Operating Junction and Storage Temperature Range		T_J, T_{stg}	-55 to +150	$^\circ\text{C}$	
Source Current (Body Diode)		I_S	61	A	
Single Pulse Drain-to-Source Avalanche Energy ($I_{L(pk)} = 3.9$ A)		E_{AS}	640	mJ	
Lead Temperature for Soldering Purposes (1/8" from case for 10 s)		T_L	260	$^\circ\text{C}$	

Stresses exceeding those listed in the Maximum Ratings table may damage the device. If any of these limits are exceeded, device functionality should not be assumed, damage may occur and reliability may be affected.

1. The entire application environment impacts the thermal resistance values shown, they are not constants and are only valid for the particular conditions noted.
2. Surface-mounted on FR4 board using a 1 in² pad size, 1 oz Cu pad.
3. Maximum current for pulses as long as 1 second is higher but is dependent on pulse duration and duty cycle.

$V_{(BR)DSS}$	$R_{DS(ON)}$ MAX	I_D MAX
80 V	10 mΩ @ 10 V	61 A

N-Channel MOSFET

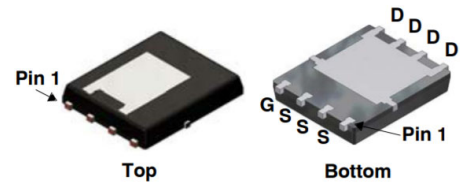
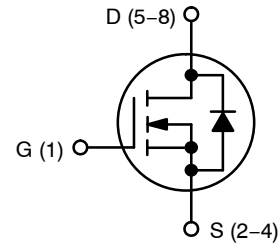

DFN8 5x6
(Dual Cool 56)
CASE 506EG

MARKING DIAGRAM

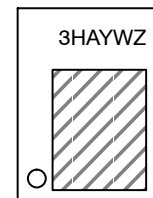

- 3H = Specific Device Code
- A = Assembly Location
- Y = Year
- W = Work Week
- Z = Assembly Lot Code

ORDERING INFORMATION

Device	Package	Shipping
NTMFSC011N08M7	DFN8 (Pb-Free)	3000 / Tape & Reel

NTMFSC011N08M7

ELECTRICAL CHARACTERISTICS ($T_J = 25^\circ\text{C}$ unless otherwise noted)

Parameter	Symbol	Test Condition	Min	Typ	Max	Unit
-----------	--------	----------------	-----	-----	-----	------

OFF CHARACTERISTICS

Drain to Source Breakdown Voltage	$V_{(BR)DSS}$	$V_{GS} = 0\text{ V}, I_D = 250\ \mu\text{A}$	80			V
Drain-to-Source Breakdown Voltage Temperature Coefficient	$V_{(BR)DSS}/T_J$			49		mV/°C
Zero Gate Voltage Drain Current	I_{DSS}	$V_{GS} = 0\text{ V}, V_{DS} = 80\text{ V}$	$T_J = 25^\circ\text{C}$		10	μA
			$T_J = 125^\circ\text{C}$		100	
Zero Gate Voltage Drain Current	I_{GSS}	$V_{DS} = 0\text{ V}, V_{GS} = \pm 20\text{ V}$			± 100	nA

ON CHARACTERISTICS (Note 4)

Gate Threshold Voltage	$V_{GS(TH)}$	$V_{GS} = V_{DS}, I_D = 120\ \mu\text{A}$	2.5	3.3	4.5	V
Threshold Temperature Coefficient	$V_{GS(TH)}/T_J$			-9		mV/°C
Drain-to-Source On Resistance	$R_{DS(on)}$	$V_{GS} = 10\text{ V}$		7.6	10	m Ω
Forward Transconductance	gFS	$V_{DS} = 5\text{ V}$		21.5	40	S

CHARGES, CAPACITANCES & GATE RESISTANCE

Input Capacitance	C_{iss}	$V_{GS} = 0\text{ V}, f = 1\text{ MHz}$	$V_{DS} = 0\text{ V}$		2373		pF
	C_{iss}		$V_{DS} = 40\text{ V}$		2080	2700	
Output Capacitance	C_{oss}				286	430	
Reverse Transfer Capacitance	C_{rss}				11	17	
Gate Resistance	R_g	$V_{GS} = 0.5\text{ V}, f = 1\text{ MHz}$		1	2		Ω
Threshold Gate Charge	$Q_{g(th)}$	$V_{GS} = 0\text{ to }2\text{ V}$	$V_{GS} = 10\text{ V},$ $V_{DS} = 40\text{ V};$ $I_D = 10\text{ A}$		4.3		nC
Total Gate Charge	$Q_{G(TOT)}$	$V_{GS} = 0\text{ to }10\text{ V}$			29.3	38	
Gate to Source Gate Charge	Q_{gs}	$V_{GS} = 0\text{ to }10\text{ V}$			11.8		V
Gate to Drain "Miller" Charge	Q_{gd}				4.3		
Plateau Voltage	V_{GP}				5.5		
Output Charge	Q_{oss}	$V_{DS} = 40\text{ V}, V_{GS} = 0\text{ V}$			26		nC

SWITCHING CHARACTERISTICS (Note 5)

Turn-On Delay Time	$t_{d(ON)}$	$V_{DD} = 40\text{ V}, I_D = 10\text{ A},$ $V_{GS} = 10\text{ V}, R_{GEN} = 6\ \Omega$		14		ns
Turn-On Rise Time	t_r			6		ns
Turn-Off Delay Time	$t_{d(OFF)}$			27		ns
Turn-Off Fall Time	t_f			6		ns

DRAIN – SOURCE DIODE CHARACTERISTICS

Source to Drain Diode Voltage	V_{SD}	$I_{SD} = 10\text{ A}, V_{GS} = 0\text{ V}$		0.82	1.2	V
Reverse Recovery Time	T_{RR}	$V_{GS} = 0\text{ V}, dI_{SD}/dt = 100\text{ A}/\mu\text{s},$ $I_S = 10\text{ A}$		41	50	ns
Charge Time	t_a			24.6		
Discharge Time	t_b			16.1		
Reverse Recovery Charge	Q_{RR}			45	58	nC

4. Pulse Test: pulse width $\leq 300\ \mu\text{s}$, duty cycle $\leq 2\%$.

5. Switching characteristics are independent of operating junction temperatures.

Product parametric performance is indicated in the Electrical Characteristics for the listed test conditions, unless otherwise noted. Product performance may not be indicated by the Electrical Characteristics if operated under different conditions.

THERMAL CHARACTERISTICS

Symbol	Parameter	Value	Unit
$R_{\theta JC}$	Thermal Resistance, Junction to Case (Top Source)	1.6	°C/W
$R_{\theta JC}$	Thermal Resistance, Junction to Case (Bottom Drain)	3.0	
$R_{\theta JA}$	Thermal Resistance, Junction to Ambient (Note 1a)	38	
$R_{\theta JA}$	Thermal Resistance, Junction to Ambient (Note 1b)	81	
$R_{\theta JA}$	Thermal Resistance, Junction to Ambient (Note 1c)	27	
$R_{\theta JA}$	Thermal Resistance, Junction to Ambient (Note 1d)	34	
$R_{\theta JA}$	Thermal Resistance, Junction to Ambient (Note 1e)	16	
$R_{\theta JA}$	Thermal Resistance, Junction to Ambient (Note 1f)	19	
$R_{\theta JA}$	Thermal Resistance, Junction to Ambient (Note 1g)	26	
$R_{\theta JA}$	Thermal Resistance, Junction to Ambient (Note 1h)	61	
$R_{\theta JA}$	Thermal Resistance, Junction to Ambient (Note 1i)	16	
$R_{\theta JA}$	Thermal Resistance, Junction to Ambient (Note 1j)	23	
$R_{\theta JA}$	Thermal Resistance, Junction to Ambient (Note 1k)	11	
$R_{\theta JA}$	Thermal Resistance, Junction to Ambient (Note 1l)	13	

6. $R_{\theta JA}$ is determined with the device mounted on a FR-4 board using a specified pad of 2 oz copper as shown below. $R_{\theta JA}$ is guaranteed by design while R_{CA} is determined by the user's board design.

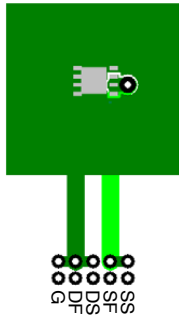

a) 38°C/W when mounted on a 1 in2 pad of 2 oz copper.



b) 81°C/W when mounted on a minimum pad of 2 oz copper.

- c) Still air, 20.9-10.4-12.7 mm Aluminum Heat Sink, 1 in2 pad of 2 oz copper
- d) Still air, 20.9-10.4-12.7 mm Aluminum Heat Sink, minimum pad of 2 oz copper
- e) Still air, 45.2-41.4-11.7 mm Aavid Thermalloy Part # 10-L41B-11 Heat Sink, 1 in2 pad of 2 oz copper
- f) Still air, 45.2-41.4-11.7 mm Aavid Thermalloy Part # 10-L41B-11 Heat Sink, minimum pad of 2 oz copper
- g) .200FPM Airflow, No Heat Sink, 1 in2 pad of 2 oz copper
- h) .200FPM Airflow, No Heat Sink, minimum pad of 2 oz copper
- i) .200FPM Airflow, 20.9-10.4-12.7 mm Aluminum Heat Sink, 1 in2 pad of 2 oz copper
- j) .200FPM Airflow, 20.9-10.4-12.7 mm Aluminum Heat Sink, minimum pad of 2 oz copper
- k) .200FPM Airflow, 45.2-41.4-11.7 mm Aavid Thermalloy Part # 10-L41B-11 Heat Sink, 1 in2 pad of 2 oz copper
- l) .200FPM Airflow, 45.2-41.4-11.7 mm Aavid Thermalloy Part # 10-L41B-11 Heat Sink, minimum pad of 2 oz copper

7. Pulse Test: Pulse Width < 300 μ s, Duty cycle < 2.0%.

TYPICAL CHARACTERISTICS

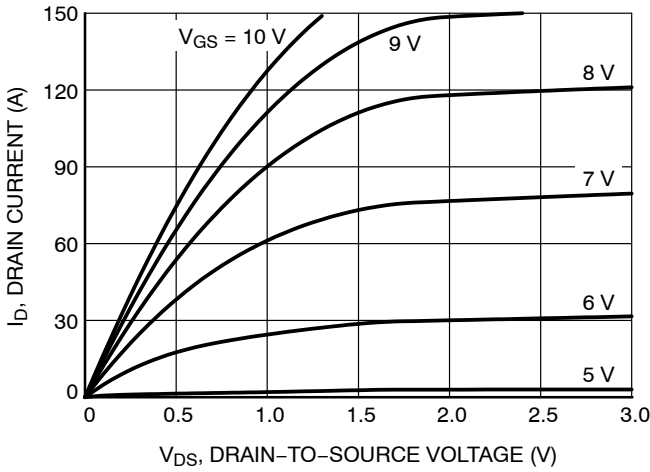

Figure 1. On-Region Characteristics

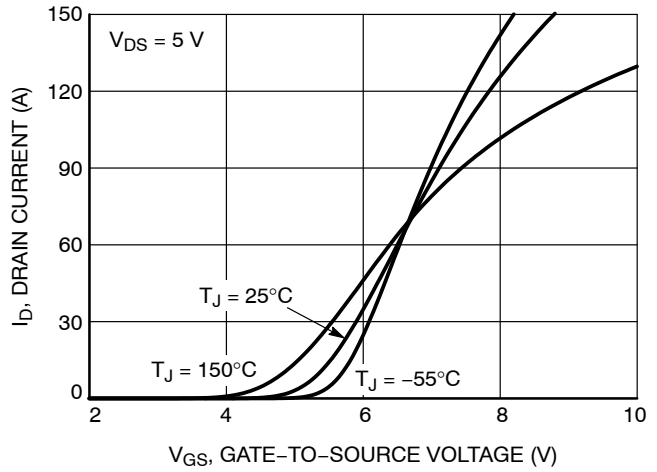

Figure 2. Transfer Characteristics

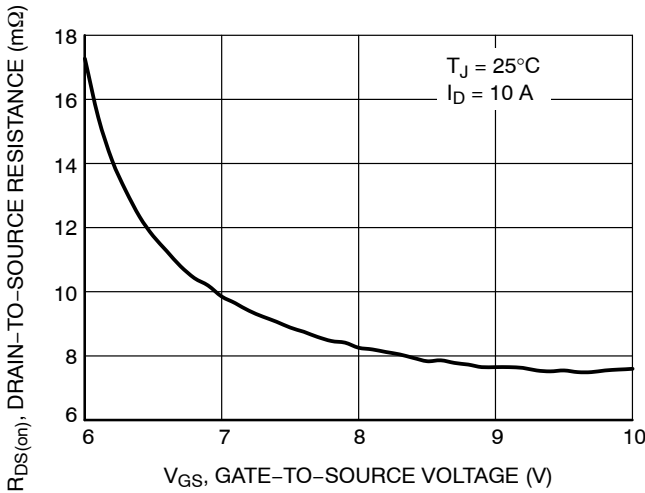

Figure 3. On-Resistance vs. Gate-to-Source Voltage

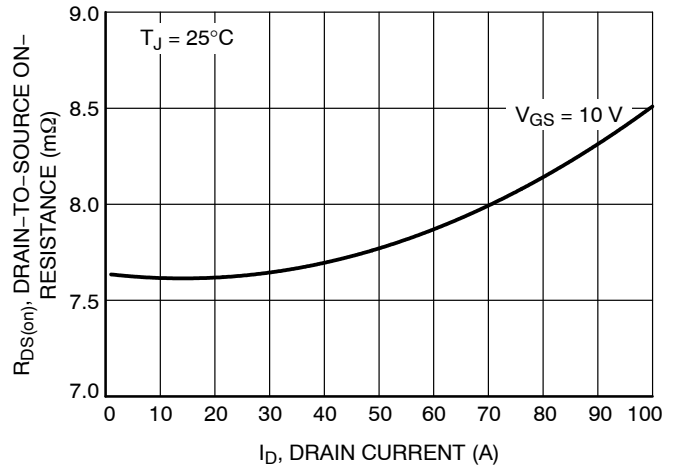

Figure 4. On-Resistance vs. Drain Current and Gate Voltage

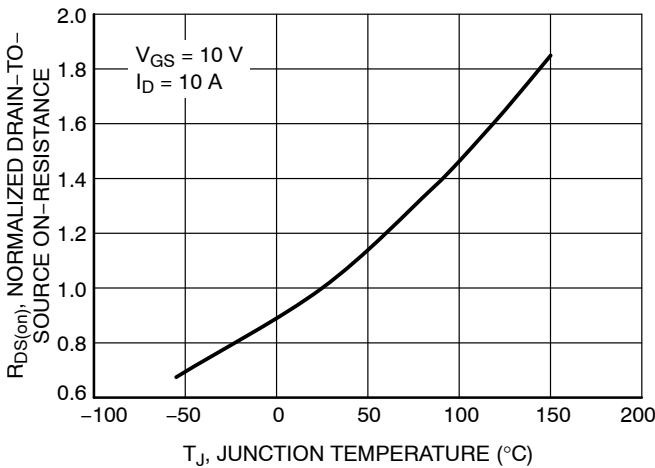

Figure 5. On-Resistance Variation with Temperature

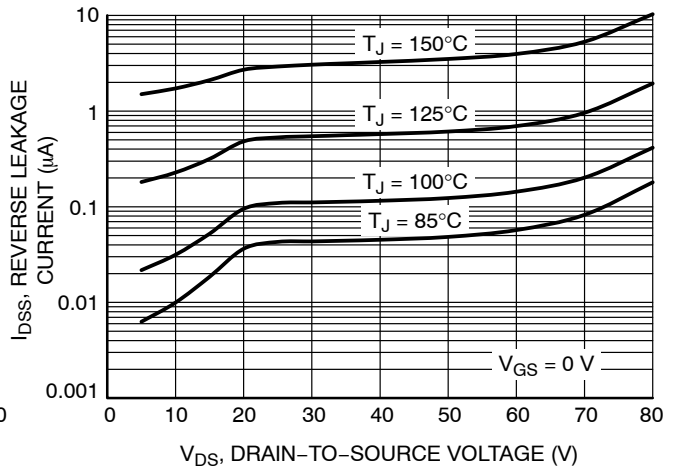

Figure 6. Drain-to-Source Leakage Current vs. Voltage

TYPICAL CHARACTERISTICS

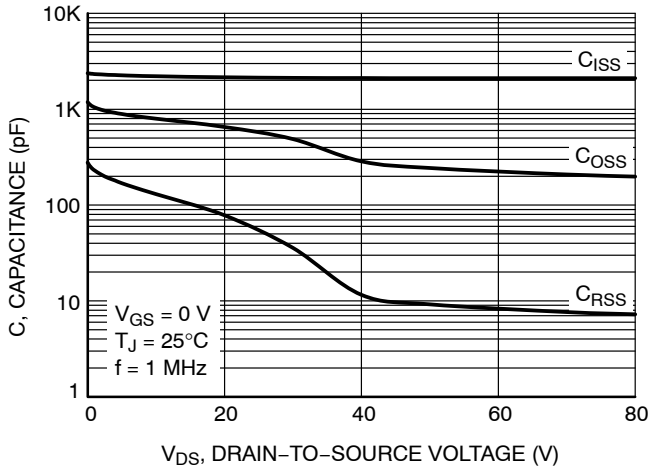

Figure 7. Capacitance Variation

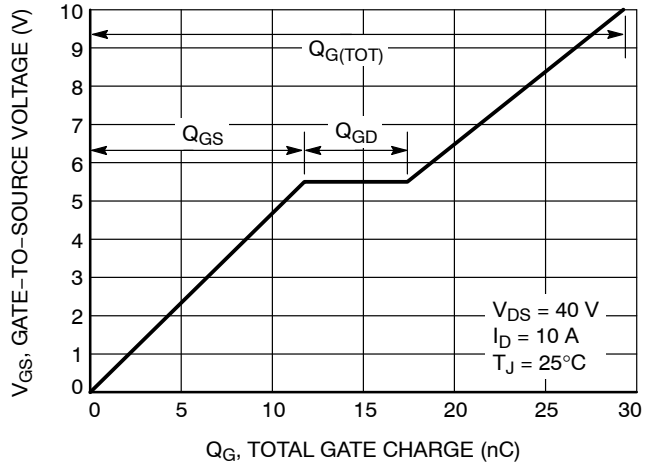

Figure 8. Gate-to-Source and Drain-to-Source Voltage vs. Total Charge

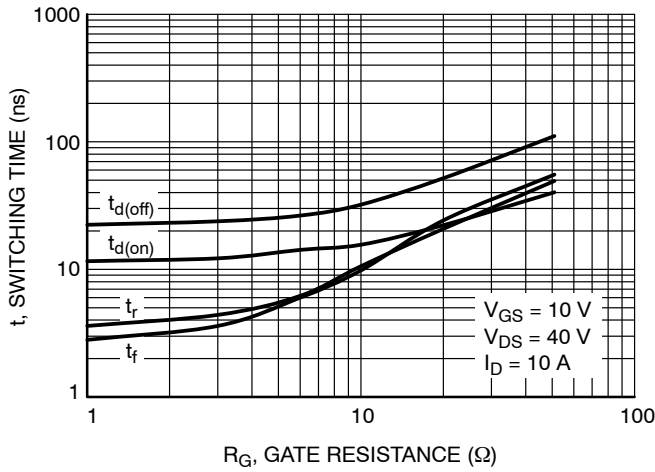

Figure 9. Resistive Switching Time Variation vs. Gate Resistance

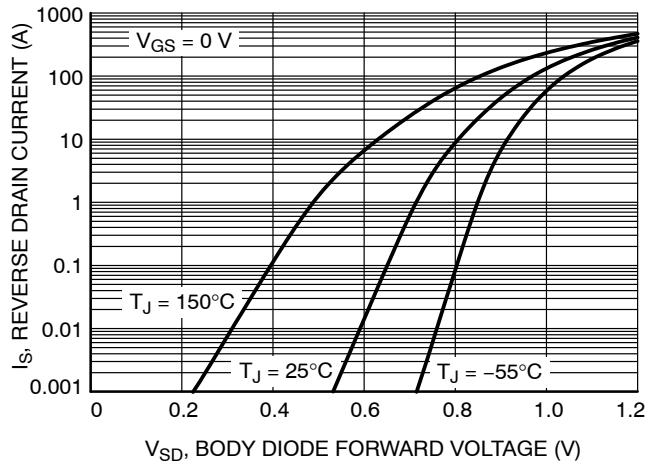

Figure 10. Diode Forward Voltage vs. Current

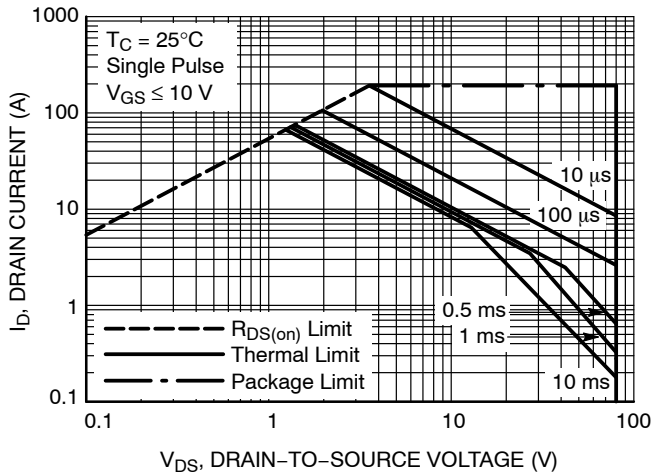

Figure 11. Safe Operating Area

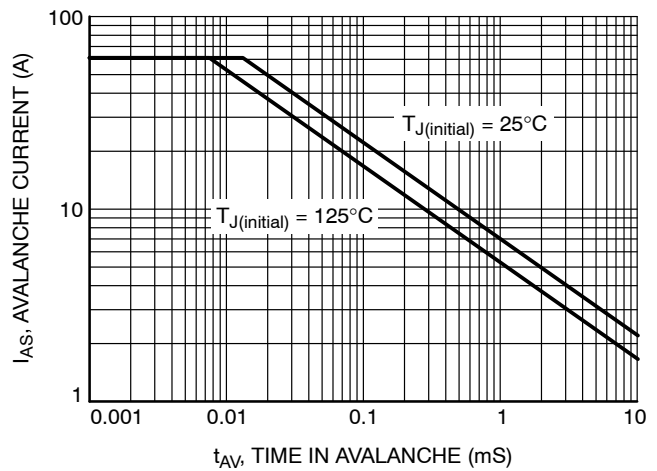

Figure 12. I_{PEAK} vs. Time in Avalanche

NTMFSC011N08M7

TYPICAL CHARACTERISTICS

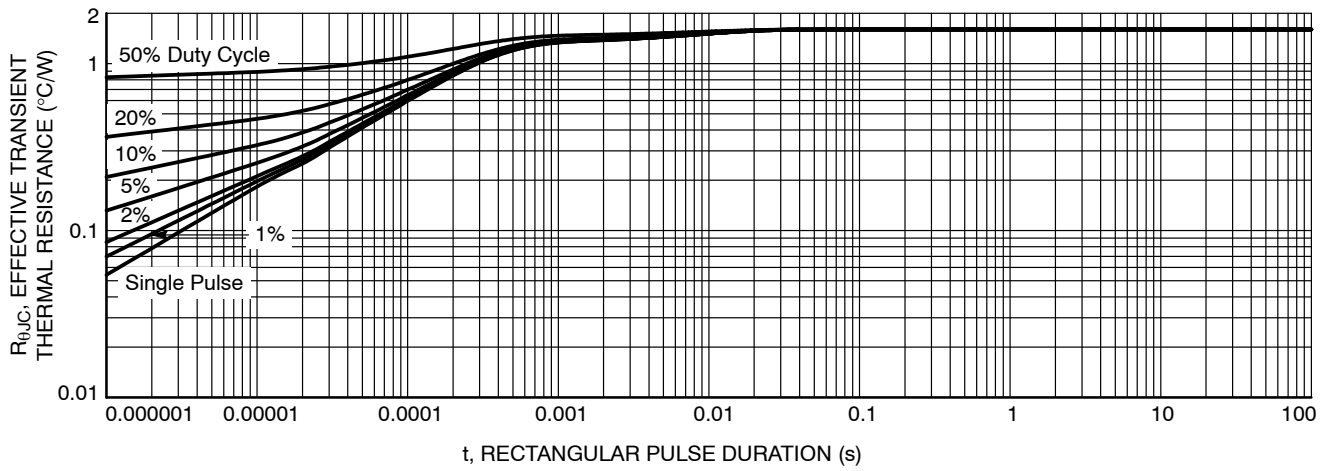

Figure 13. Thermal Response

MECHANICAL CASE OUTLINE

PACKAGE DIMENSIONS

ON Semiconductor®



DFN8 5x6.15, 1.27P, DUAL COOL CASE 506EG ISSUE D

DATE 25 AUG 2020

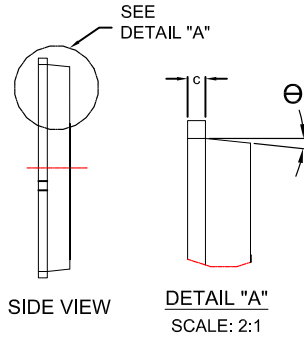
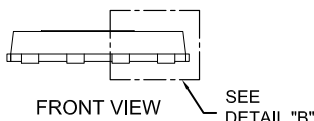
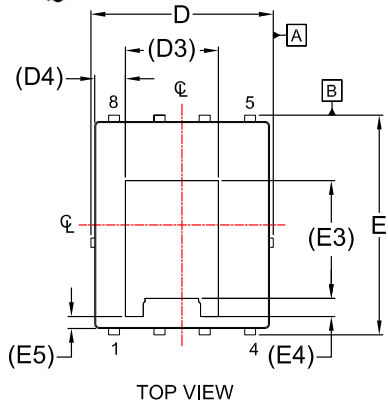
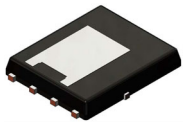

NOTES:

1. DIMENSIONING AND TOLERANCING PER ASME Y14.5M, 2009.
2. CONTROLLING DIMENSION: MILLIMETERS
3. COPLANARITY APPLIES TO THE EXPOSED PADS AS WELL AS THE TERMINALS.
4. DIMENSIONS D1 AND E1 DO NOT INCLUDE MOLD FLASH, PROTRUSIONS, OR GATE BURRS.
5. SEATING PLANE IS DEFINED BY THE TERMINALS. "A1" IS DEFINED AS THE DISTANCE FROM THE SEATING PLANE TO THE LOWEST POINT ON THE PACKAGE BODY.

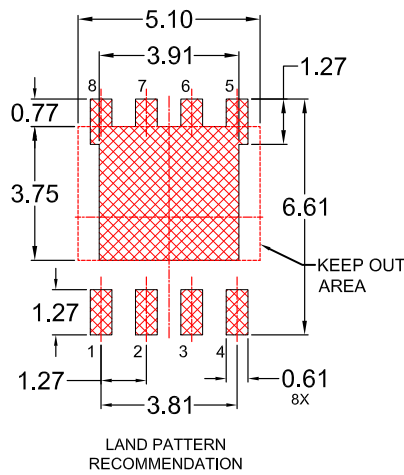
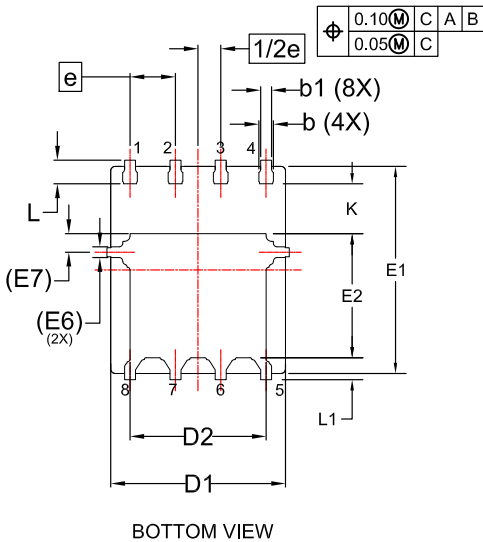
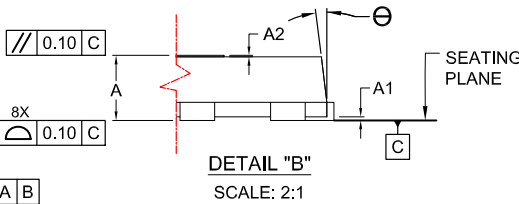

*FOR ADDITIONAL INFORMATION ON OUR PB-FREE STRATEGY AND SOLDERING DETAILS, PLEASE DOWNLOAD THE ON SEMICONDUCTOR SOLDERING AND MOUNTING TECHNIQUES REFERENCE MANUAL, SOLDERRM/D.

DIM	MILLIMETERS		
	MIN.	NOM.	MAX.
A	0.85	0.90	0.95
A1	-	-	0.05
A2	-	-	0.05
b	0.31	0.41	0.51
b1	0.21	0.31	0.41
c	0.20	0.25	0.30
D	4.90	5.00	5.10
D1	4.80	4.90	5.00
D2	3.67	3.82	3.97
D3	2.60 REF		
D4	0.86 REF		
E	6.05	6.15	6.25
E1	5.70	5.80	5.90
E2	3.38	3.48	3.58
E3	3.30 REF		
E4	0.50 REF		
E5	0.34 REF		
E6	0.30 REF		
E7	0.52 REF		
e	1.27 BSC		
1/2e	0.635 BSC		
K	1.30	1.40	1.50
L	0.56	0.66	0.76
L1	0.52	0.62	0.72
θ	0°	---	12°

GENERIC MARKING DIAGRAM*

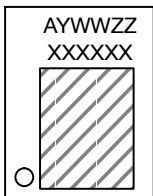

XXXX = Specific Device Code
 A = Assembly Location
 Y = Year
 WW = Work Week
 ZZ = Assembly Lot Code

*This information is generic. Please refer to device data sheet for actual part marking. Pb-Free indicator, "G" or microdot "•", may or may not be present. Some products may not follow the Generic Marking.

DOCUMENT NUMBER:	98AON84257G	Electronic versions are uncontrolled except when accessed directly from the Document Repository. Printed versions are uncontrolled except when stamped "CONTROLLED COPY" in red.
DESCRIPTION:	DFN8 5x6.15, 1.27P, DUAL COOL	PAGE 1 OF 1

ON Semiconductor and are trademarks of Semiconductor Components Industries, LLC dba ON Semiconductor or its subsidiaries in the United States and/or other countries. ON Semiconductor reserves the right to make changes without further notice to any products herein. ON Semiconductor makes no warranty, representation or guarantee regarding the suitability of its products for any particular purpose, nor does ON Semiconductor assume any liability arising out of the application or use of any product or circuit, and specifically disclaims any and all liability, including without limitation special, consequential or incidental damages. ON Semiconductor does not convey any license under its patent rights nor the rights of others.

onsemi, **Onsemi**, and other names, marks, and brands are registered and/or common law trademarks of Semiconductor Components Industries, LLC dba "**onsemi**" or its affiliates and/or subsidiaries in the United States and/or other countries. **onsemi** owns the rights to a number of patents, trademarks, copyrights, trade secrets, and other intellectual property. A listing of **onsemi**'s product/patent coverage may be accessed at www.onsemi.com/site/pdf/Patent-Marking.pdf. **onsemi** reserves the right to make changes at any time to any products or information herein, without notice. The information herein is provided "as-is" and **onsemi** makes no warranty, representation or guarantee regarding the accuracy of the information, product features, availability, functionality, or suitability of its products for any particular purpose, nor does **onsemi** assume any liability arising out of the application or use of any product or circuit, and specifically disclaims any and all liability, including without limitation special, consequential or incidental damages. Buyer is responsible for its products and applications using **onsemi** products, including compliance with all laws, regulations and safety requirements or standards, regardless of any support or applications information provided by **onsemi**. "Typical" parameters which may be provided in **onsemi** data sheets and/or specifications can and do vary in different applications and actual performance may vary over time. All operating parameters, including "Typicals" must be validated for each customer application by customer's technical experts. **onsemi** does not convey any license under any of its intellectual property rights nor the rights of others. **onsemi** products are not designed, intended, or authorized for use as a critical component in life support systems or any FDA Class 3 medical devices or medical devices with a same or similar classification in a foreign jurisdiction or any devices intended for implantation in the human body. Should Buyer purchase or use **onsemi** products for any such unintended or unauthorized application, Buyer shall indemnify and hold **onsemi** and its officers, employees, subsidiaries, affiliates, and distributors harmless against all claims, costs, damages, and expenses, and reasonable attorney fees arising out of, directly or indirectly, any claim of personal injury or death associated with such unintended or unauthorized use, even if such claim alleges that **onsemi** was negligent regarding the design or manufacture of the part. **onsemi** is an Equal Opportunity/Affirmative Action Employer. This literature is subject to all applicable copyright laws and is not for resale in any manner.

ADDITIONAL INFORMATION

TECHNICAL PUBLICATIONS:

Technical Library: www.onsemi.com/design/resources/technical-documentation
onsemi Website: www.onsemi.com

ONLINE SUPPORT: www.onsemi.com/support

For additional information, please contact your local Sales Representative at www.onsemi.com/support/sales