

# MOSFET - Power, Dual N- & P-Channel, SO8

100 V, 83 mΩ, 4.5 A,  
-100 V, 131 mΩ, -3.6 A



ON Semiconductor®

[www.onsemi.com](http://www.onsemi.com)

## NTMC083NP10M5L

### Features

- Small Footprint (5 x 6 mm) for Compact Design
- Low  $R_{DS(on)}$  to Minimize Conduction Losses
- Low  $Q_G$  and Capacitance to Minimize Driver Losses
- The Part is Not ESD Protected
- These Devices are Pb-Free, Halogen Free/BFR Free and are RoHS Compliant

### Typical Applications

- Power Tools, Battery Operated Vacuums
- UAV/Drones, Material Handling
- Motor Drive, Home Automation

### MAXIMUM RATINGS ( $T_J = 25^\circ\text{C}$ , Unless otherwise specified)

Parameter		Symbol	Q1	Q2	Unit	
Drain-to-Source Breakdown Voltage		$V_{(BR)DSS}$	100	-100	V	
Gate-to-Source Voltage		$V_{GS}$	$\pm 20$	$\pm 20$	V	
Continuous Drain Current $R_{\theta JC}$ (Note 2)	Steady State	$I_D$	$T_C = 25^\circ\text{C}$	4.1	-3.3	A
			$T_C = 100^\circ\text{C}$	2.5	-2	
Power Dissipation $R_{\theta JC}$ (Note 2)	Steady State	$P_D$	$T_C = 25^\circ\text{C}$	3.1	3.1	W
			$T_C = 100^\circ\text{C}$	1.2	1.2	
Continuous Drain Current $R_{\theta JA}$ (Notes 1, 2)	Steady State	$I_D$	$T_A = 25^\circ\text{C}$	2.9	-2.4	A
			$T_A = 100^\circ\text{C}$	1.8	-1.4	
Power Dissipation $R_{\theta JA}$ (Notes 1, 2)	Steady State	$P_D$	$T_A = 25^\circ\text{C}$	1.6	1.6	W
			$T_A = 100^\circ\text{C}$	0.6	0.6	
Pulsed Drain Current	$T_A = 25^\circ\text{C}$ , $t_p = 10 \mu\text{s}$	$I_{DM}$	20	20	A	
Operating Junction and Storage Temperature Range		$T_J, T_{stg}$	-55 to +150		$^\circ\text{C}$	
Source Current (Body Diode)		$I_S$	3	3	A	
Single Pulse Drain-to-Source Avalanche Energy ( $I_L = 6 \text{ A}$ , $8.2 \text{ A}$ , $L = 1 \text{ mH}$ )		$E_{AS}$	18	34	mJ	
Lead Temperature Soldering Reflow for Soldering Purposes (1/8" from case for 10 s)		$T_L$	260	260	$^\circ\text{C}$	

Stresses exceeding those listed in the Maximum Ratings table may damage the device. If any of these limits are exceeded, device functionality should not be assumed, damage may occur and reliability may be affected.

1. Surface-mounted on FR4 board using 1 in<sup>2</sup> pad size, 1 oz Cu pad.
2. The entire application environment impacts the thermal resistance values shown, they are not constants and are only valid for the particular conditions noted.

$V_{(BR)DSS}$	$R_{DS(on)}$ MAX	$I_D$ MAX
100 V	83 mΩ @ 10 V	4.5 A
-100 V	131 mΩ @ 10 V	-3.6 A

### Dual-Channel MOSFET

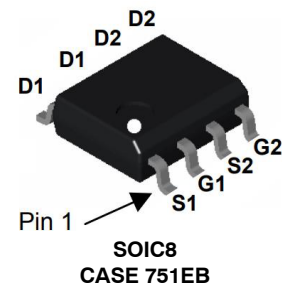
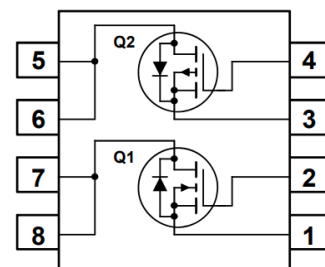

### MARKING DIAGRAM

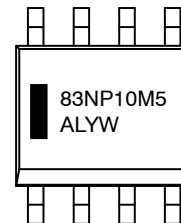

- A = Assembly Location
- L = Wafer Lot
- Y = Year
- W = Work Week

### ORDERING INFORMATION

See detailed ordering and shipping information on page 4 of this data sheet.

# NTMC083NP10M5L

## THERMAL CHARACTERISTICS

Symbol	Parameter	Q1	Q2	Unit
$R_{\theta JC}$	Junction-to-Case – Steady State (Note 3)	40	40	°C/W
$R_{\theta JA}$	Junction-to-Ambient – Steady State (Note 3)	78	78	

3. The entire application environment impacts the thermal resistance values shown, they are not constants and are only valid for the particular conditions noted.

## ELECTRICAL CHARACTERISTICS (Q1, N-CHANNEL) ( $T_J = 25^\circ\text{C}$ unless otherwise noted)

Parameter	Symbol	Test Conditions	Min	Typ	Max	Unit
-----------	--------	-----------------	-----	-----	-----	------

### OFF CHARACTERISTICS

Drain-to-Source Breakdown Voltage	$V_{(BR)DSS}$	$V_{GS} = 0\text{ V}, I_D = 250\ \mu\text{A}$	100			V
Drain-to-Source Breakdown Voltage Temperature Coefficient	$V_{(BR)DSS} / T_J$	$I_D = 250\ \mu\text{A}, \text{ref to } 25^\circ\text{C}$		60		mV/°C
Zero Gate Voltage Drain Current	$I_{DSS}$	$V_{GS} = 0\text{ V}, V_{DS} = 80\text{ V}$	$T_J = 25^\circ\text{C}$		1	$\mu\text{A}$
			$T_J = 125^\circ\text{C}$		100	
Gate-to-Source Leakage Current	$I_{GSS}$	$V_{DS} = 0\text{ V}, V_{GS} = \pm 20\text{ V}$			$\pm 100$	nA

### ON CHARACTERISTICS

Gate Threshold Voltage	$V_{GS(TH)}$	$V_{GS} = V_{DS}, I_D = 28\ \mu\text{A}$	1.0	1.9	3.0	V
Negative Threshold Temperature Coefficient	$V_{GS(TH)} / T_J$	$I_D = 22\ \mu\text{A}, \text{ref to } 25^\circ\text{C}$		8.2		mV/°C
Drain-to-Source On Resistance	$R_{DS(on)}$	$V_{GS} = 10\text{ V}, I_D = 1.5\text{ A}$		59.4	83	m $\Omega$
		$V_{GS} = 4.5\text{ V}, I_D = 1.2\text{ A}$		96.3	118	
Forward Transconductance	$g_{FS}$	$V_{DS} = 5\text{ V}, I_D = 4\text{ A}$		7.1		S
Gate-Resistance	$R_G$	$T_A = 25^\circ\text{C}$		1.21		$\Omega$

### CHARGES & CAPACITANCES

Input Capacitance	$C_{ISS}$	$V_{GS} = 0\text{ V}, f = 1\text{ MHz}, V_{DS} = 50\text{ V}$		222		pF
Output Capacitance	$C_{OSS}$			55.4		
Reverse Transfer Capacitance	$C_{RSS}$			2.6		
Total Gate Charge	$Q_{G(TOT)}$	$V_{GS} = 4.5\text{ V}, V_{DS} = 50\text{ V}, I_D = 1.5\text{ A}$		3		nC
Threshold Gate Charge	$Q_{G(TH)}$			0.6		
Gate-to-Source Charge	$Q_{GS}$			0.9		
Gate-to-Drain Charge	$Q_{GD}$			1		
Total Gate Charge	$Q_{G(TOT)}$	$V_{GS} = 10\text{ V}, V_{DD} = 50\text{ V}, I_D = 1.5\text{ A}$		5		

### SWITCHING CHARACTERISTICS

Turn-On Delay Time	$t_{d(ON)}$	$V_{GS} = 10\text{ V}, V_{DS} = 50\text{ V}, I_D = 1.5\text{ A}, R_G = 6\ \Omega$		8.4		ns
Rise Time	$t_r$			8		
Turn-Off Delay Time	$t_{d(OFF)}$			8.9		
Fall Time	$t_f$			6.2		
Turn-On Delay Time	$t_{d(ON)}$	$V_{GS} = 4.5\text{ V}, V_{DS} = 50\text{ V}, I_D = 1.5\text{ A}, R_G = 6\ \Omega$		5.7		ns
Rise Time	$t_r$			2		
Turn-Off Delay Time	$t_{d(OFF)}$			11.2		
Fall Time	$t_f$			4.6		

### OFF CHARACTERISTICS

Forward Diode Voltage	$V_{SD}$	$V_{GS} = 0\text{ V}, I_S = 1.5\text{ A}$	$T_J = 25^\circ\text{C}$		0.8	1.2	V
			$T_J = 125^\circ\text{C}$		1.3		

# NTMC083NP10M5L

## ELECTRICAL CHARACTERISTICS (Q1, N-CHANNEL) ( $T_J = 25^\circ\text{C}$ unless otherwise noted) (continued)

Parameter	Symbol	Test Conditions	Min	Typ	Max	Unit
<b>OFF CHARACTERISTICS</b>						
Reverse Recovery Time	$t_{RR}$	$V_{GS} = 0\text{ V}, dI_S/dt = 100\text{ A}/\mu\text{s},$ $I_S = 0.8\text{ A}$		19		ns
Charge Time	$t_a$			13		
Discharge Time	$t_b$			6		
Reverse Recovery Charge	$Q_{RR}$			11		nC

Product parametric performance is indicated in the Electrical Characteristics for the listed test conditions, unless otherwise noted. Product performance may not be indicated by the Electrical Characteristics if operated under different conditions.

## ELECTRICAL CHARACTERISTICS (Q2, P-CHANNEL) ( $T_J = 25^\circ\text{C}$ unless otherwise noted)

Parameter	Symbol	Test Conditions	Min	Typ	Max	Unit
<b>OFF CHARACTERISTICS</b>						
Drain-to-Source Breakdown Voltage	$V_{(BR)DSS}$	$V_{GS} = 0\text{ V}, I_D = 250\text{ }\mu\text{A}$	100			V
Drain-to-Source Breakdown Voltage Temperature Coefficient	$V_{(BR)DSS} / T_J$	$I_D = 250\text{ }\mu\text{A}, \text{ref to } 25^\circ\text{C}$		54		$\text{mV}/^\circ\text{C}$
Zero Gate Voltage Drain Current	$I_{DSS}$	$V_{GS} = 0\text{ V}, V_{DS} = 80\text{ V}$	$T_J = 25^\circ\text{C}$		1	$\mu\text{A}$
			$T_J = 125^\circ\text{C}$		100	
Gate-to-Source Leakage Current	$I_{GSS}$	$V_{DS} = 0\text{ V}, V_{GS} = \pm 20\text{ V}$			$\pm 100$	nA

## ON CHARACTERISTICS

Gate Threshold Voltage	$V_{GS(TH)}$	$V_{GS} = V_{DS}, I_D = -28\text{ }\mu\text{A}$	-2.0	-3.0	-4.0	V
Negative Threshold Temperature Coefficient	$V_{GS(TH)} / T_J$	$I_D = -28\text{ }\mu\text{A}, \text{ref to } 25^\circ\text{C}$		6.61		$\text{mV}/^\circ\text{C}$
Drain-to-Source On Resistance	$R_{DS(on)}$	$V_{GS} = 110\text{ V}, I_D = -1.5\text{ A}$		109	131	$\text{m}\Omega$
		$V_{GS} = -6\text{ V}, I_D = -1\text{ A}$		141	198	
Forward Transconductance	$g_{FS}$	$V_{DS} = 5\text{ V}, I_D = -7\text{ A}$		7.9		S
Gate-Resistance	$R_G$	$T_A = 25^\circ\text{C}$		3.36		$\Omega$

## CHARGES & CAPACITANCES

Input Capacitance	$C_{ISS}$	$V_{GS} = 0\text{ V}, f = 1\text{ MHz}, V_{DS} = -50\text{ V}$		525		pF
Output Capacitance	$C_{OSS}$			88		
Reverse Transfer Capacitance	$C_{RSS}$			4		
Total Gate Charge	$Q_{G(TOT)}$	$V_{GS} = -10\text{ V}, V_{DS} = -50\text{ V}, I_D = -1.5\text{ A}$		8.4		nC
Threshold Gate Charge	$Q_{G(TH)}$			1.8		
Gate-to-Source Charge	$Q_{GS}$			2.7		
Gate-to-Drain Charge	$Q_{GD}$			1.3		
Total Gate Charge	$Q_{G(TOT)}$	$V_{GS} = 6\text{ V}, V_{DD} = 50\text{ V}, I_D = -1.5\text{ A}$		5.2		

## SWITCHING CHARACTERISTICS

Turn-On Delay Time	$t_{d(ON)}$	$V_{GS} = 10\text{ V}, V_{DS} = -50\text{ V}, I_D = -1.5\text{ A},$ $R_G = 6\text{ }\Omega$		10.1		ns
Rise Time	$t_r$			2.7		
Turn-Off Delay Time	$t_{d(OFF)}$			15.9		
Fall Time	$t_f$			6.8		
Turn-On Delay Time	$t_{d(ON)}$	$V_{GS} = -6\text{ V}, V_{DS} = -50\text{ V}, I_D = -41.5\text{ A},$ $R_G = 6\text{ }\Omega$		13.3		ns
Rise Time	$t_r$			5.7		
Turn-Off Delay Time	$t_{d(OFF)}$			12.5		
Fall Time	$t_f$			7		

# NTMC083NP10M5L

## ELECTRICAL CHARACTERISTICS (Q2, P-CHANNEL) ( $T_J = 25^\circ\text{C}$ unless otherwise noted) (continued)

Parameter	Symbol	Test Conditions	Min	Typ	Max	Unit	
<b>OFF CHARACTERISTICS</b>							
Forward Diode Voltage	$V_{SD}$	$V_{GS} = 0\text{ V},$ $I_S = -1.5\text{ A}$	$T_J = 25^\circ\text{C}$		-0.8	-1.2	V
Forward Diode Voltage			$T_J = 125^\circ\text{C}$		-0.7		
Reverse Recovery Time	$t_{RR}$	$V_{GS} = 0\text{ V}, dI_S/dt = 100\text{ A}/\mu\text{s},$ $I_S = -0.8\text{ A}$			31		ns
Charge Time	$t_a$				23		
Discharge Time	$t_b$				8		
Reverse Recovery Charge	$Q_{RR}$				42		

Product parametric performance is indicated in the Electrical Characteristics for the listed test conditions, unless otherwise noted. Product performance may not be indicated by the Electrical Characteristics if operated under different conditions.

## ORDERING INFORMATION

Device	Device Marking	Package	Shipping (Qty / Packing) <sup>†</sup>
NTMC083NP10M5L	83NP10M5	SO8 (Pb-Free/Halogen Free)	2500 / Tape & Reel

<sup>†</sup>For information on tape and reel specifications, including part orientation and tape sizes, please refer to our Tape and Reel Packaging Specifications Brochure, BRD8011/D.

# NTMC083NP10M5L

## TYPICAL CHARACTERISTICS – N-CHANNEL

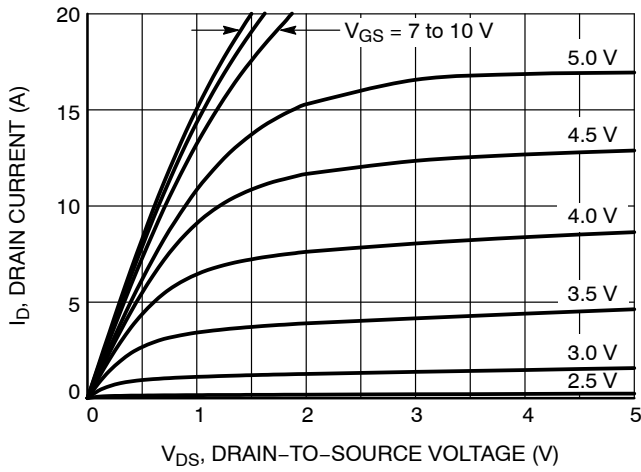

Figure 1. On-Region Characteristics

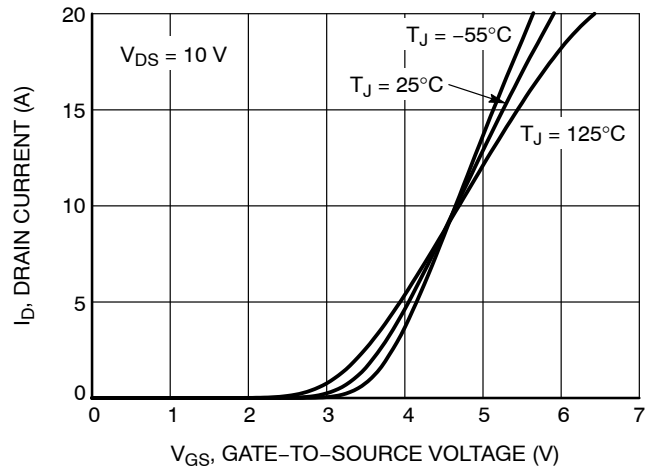

Figure 2. Transfer Characteristics

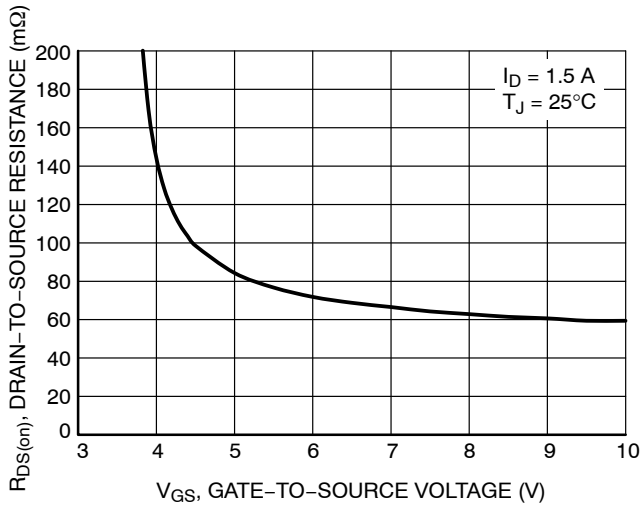

Figure 3. On-Resistance vs. Gate-to-Source Voltage

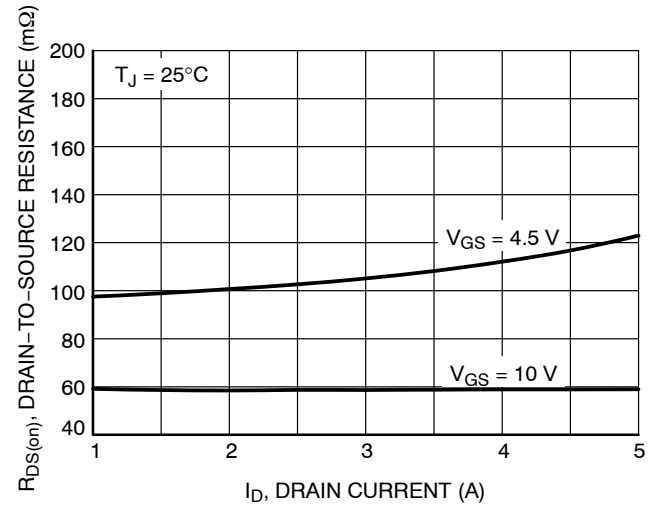

Figure 4. On-Resistance vs. Drain Current and Gate Voltage

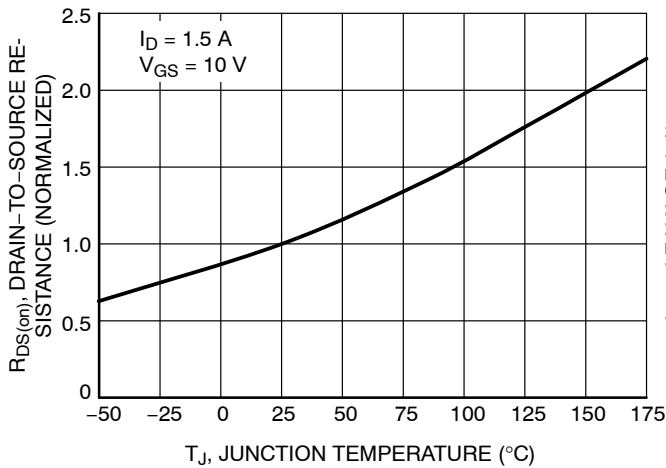

Figure 5. On-Resistance Variation with Temperature

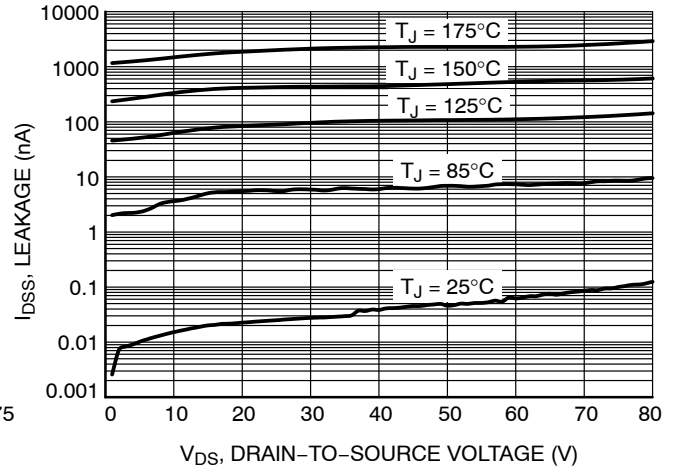

Figure 6. Drain-to-Source Leakage Current vs. Voltage

# NTMC083NP10M5L

## TYPICAL CHARACTERISTICS – N-CHANNEL

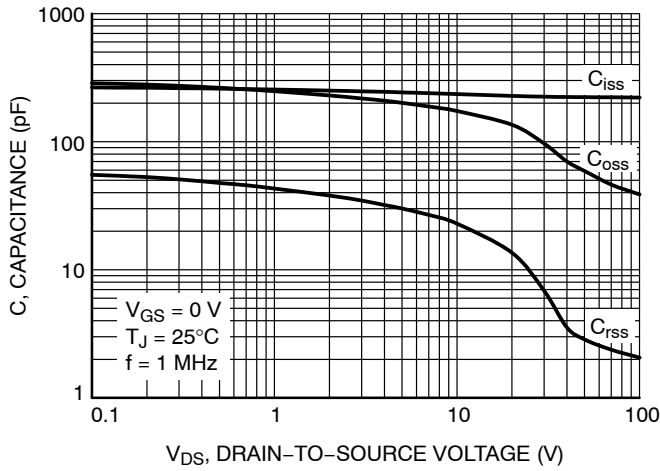

Figure 7. Capacitance Variation

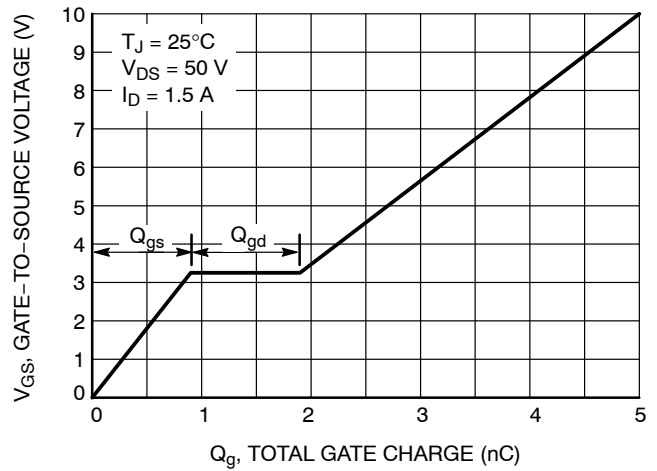

Figure 8. Gate-to-Source vs. Total Charge

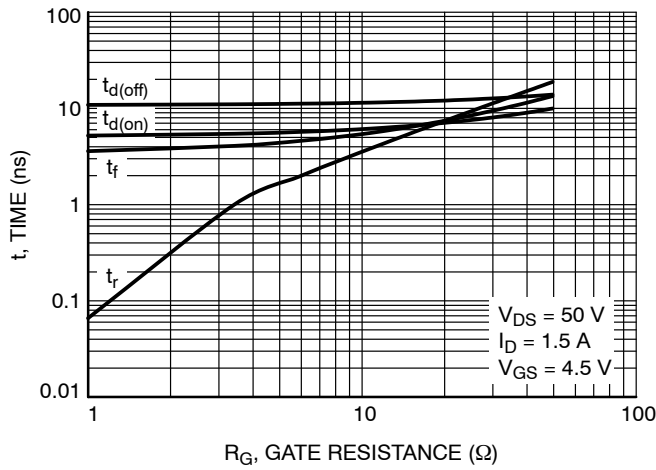

Figure 9. Resistive Switching Time Variation vs. Gate Resistance

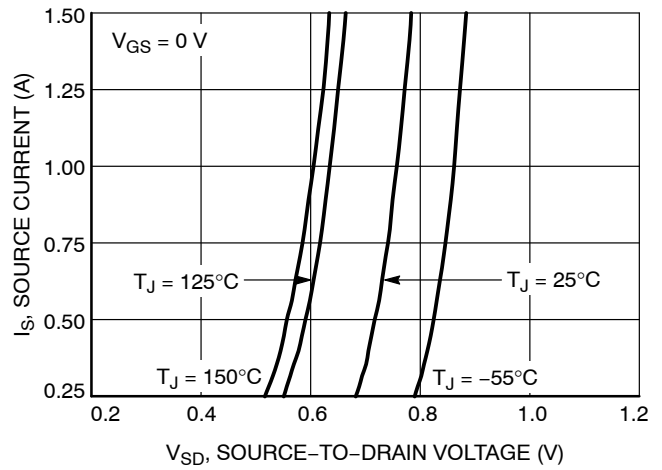

Figure 10. Diode Forward Voltage vs. Current

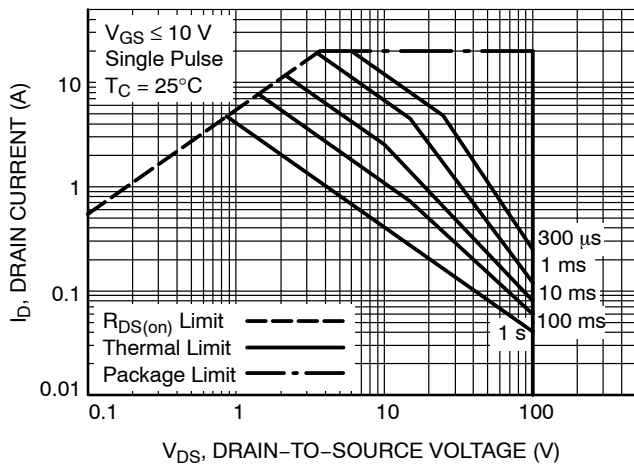

Figure 11. Maximum Rated Forward Biased Safe Operating Area

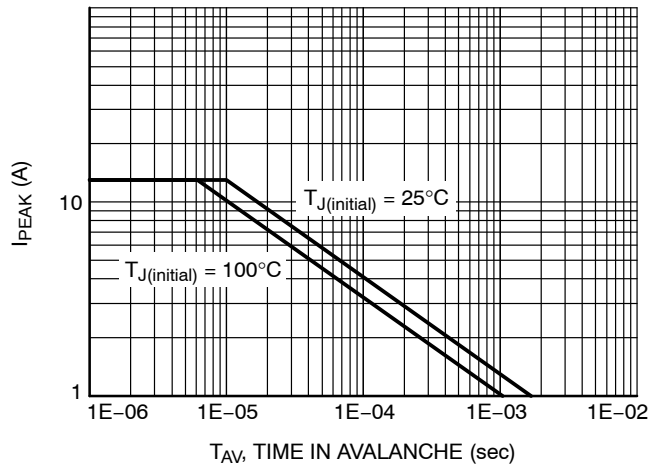

Figure 12. Maximum Drain Current vs. Time in Avalanche

# NTMC083NP10M5L

## TYPICAL CHARACTERISTICS – N-CHANNEL

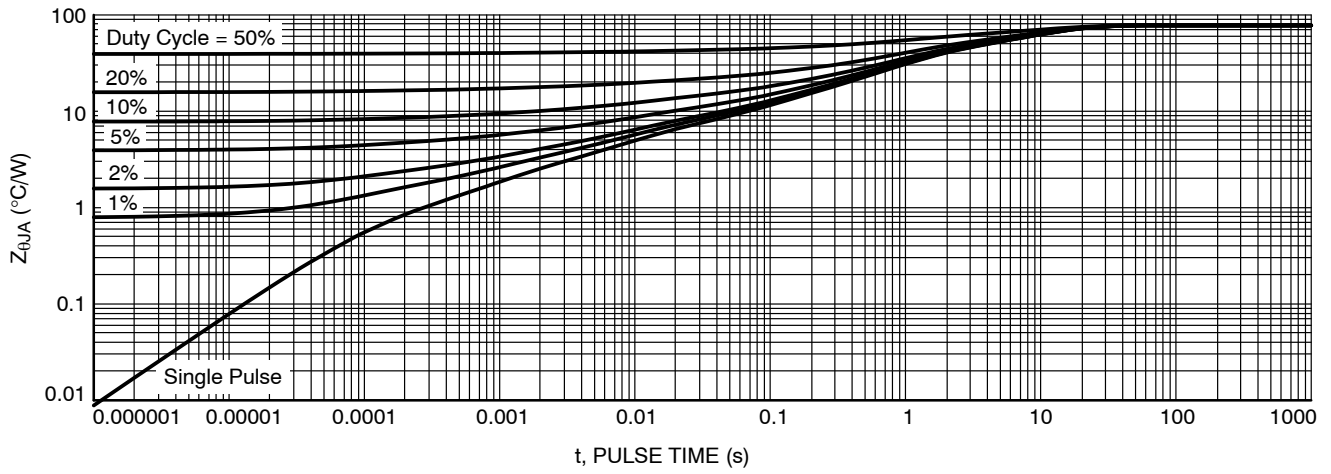

Figure 13. Thermal Response

TYPICAL CHARACTERISTICS – P-CHANNEL

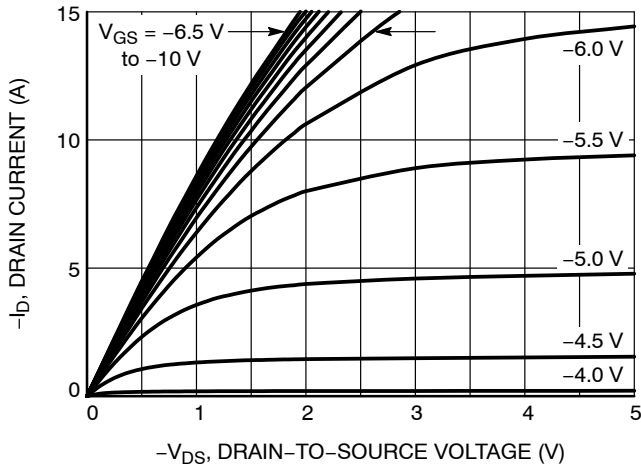

Figure 14. On-Region Characteristics

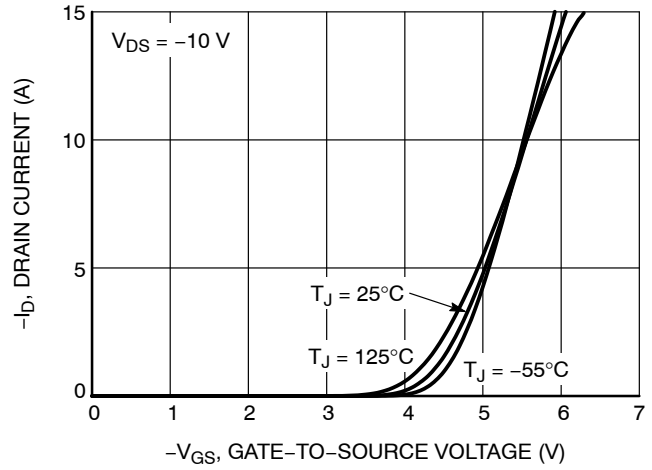

Figure 15. Transfer Characteristics

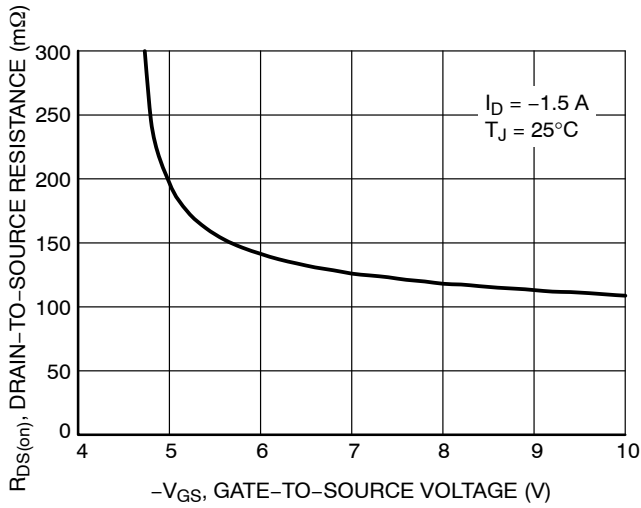

Figure 16. On-Resistance vs. Gate-to-Source Voltage

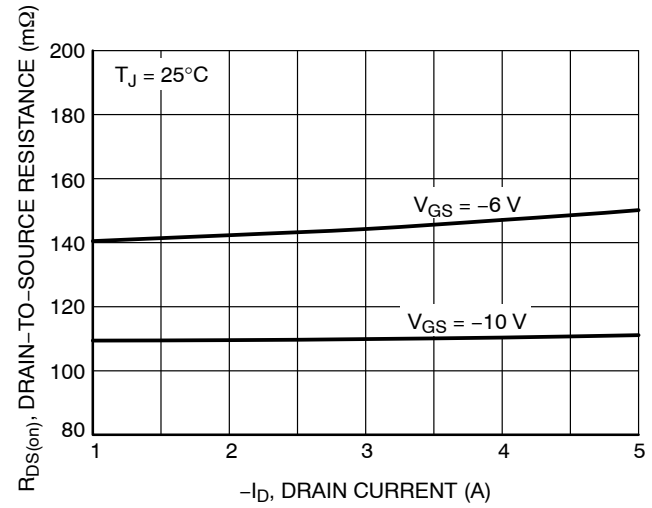

Figure 17. On-Resistance vs. Drain Current and Gate Voltage

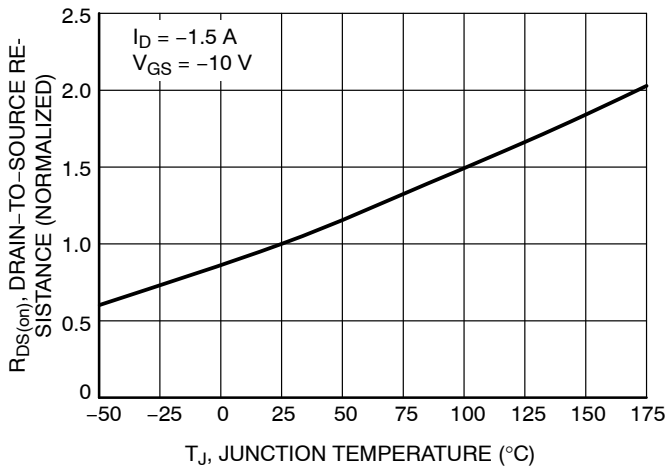

Figure 18. On-Resistance Variation with Temperature

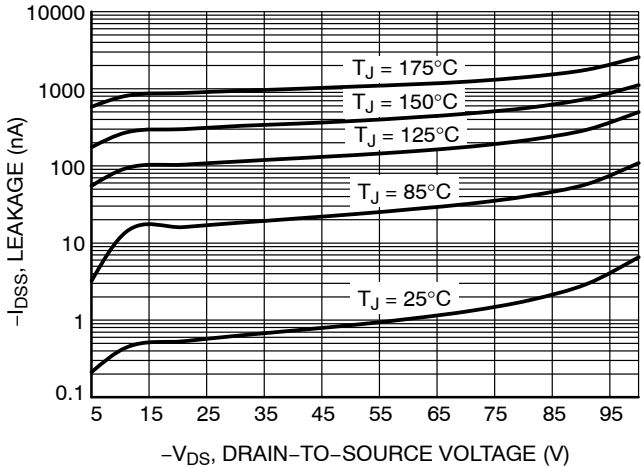
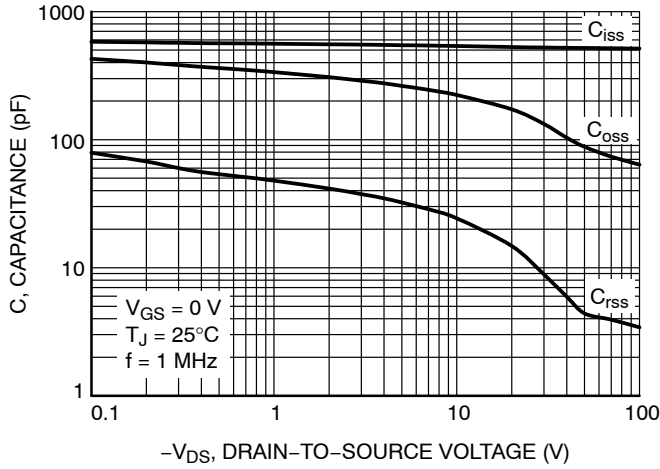

Figure 19. Drain-to-Source Leakage Current vs. Voltage



# NTMC083NP10M5L

## TYPICAL CHARACTERISTICS – P-CHANNEL



**Figure 20. Capacitance Variation**

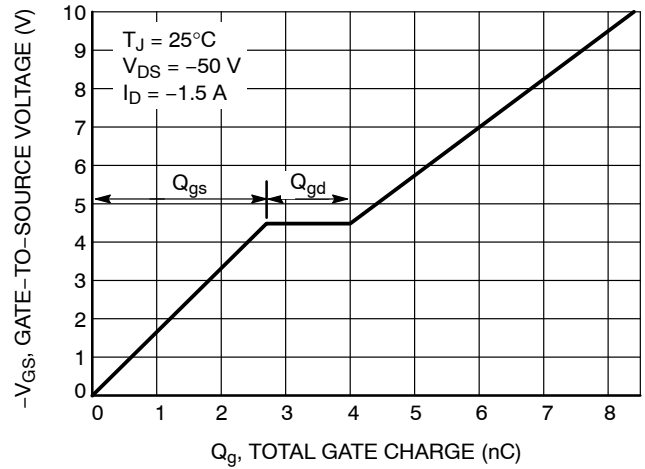

**Figure 21. Gate-to-Source vs. Total Charge**

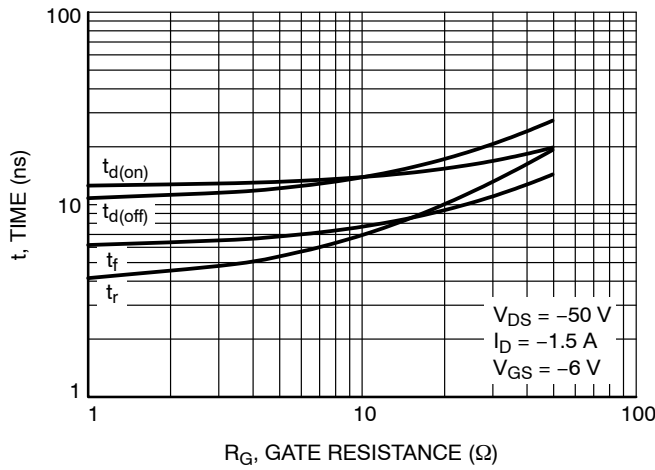

**Figure 22. Resistive Switching Time Variation vs. Gate Resistance**

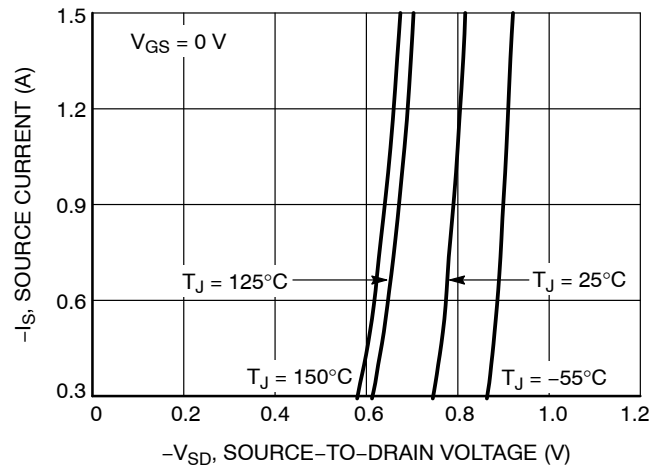

**Figure 23. Diode Forward Voltage vs. Current**

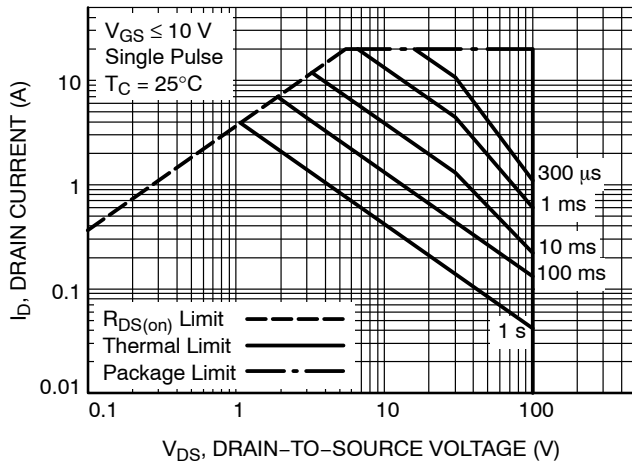

**Figure 24. Maximum Rated Forward Biased Safe Operating Area**

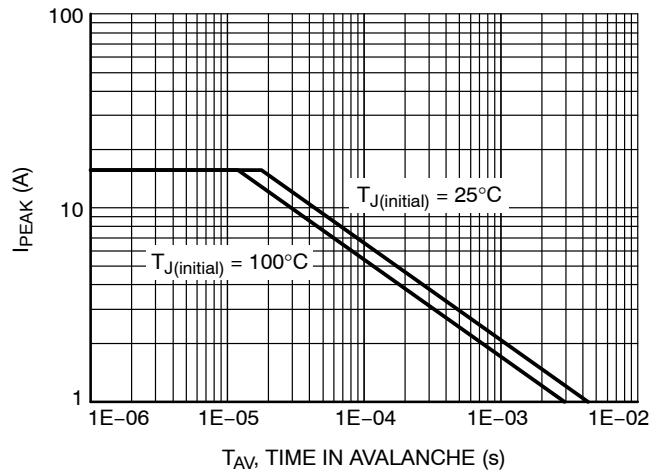

**Figure 25. Maximum Drain Current vs. Time in Avalanche**

# NTMC083NP10M5L

## TYPICAL CHARACTERISTICS – P-CHANNEL

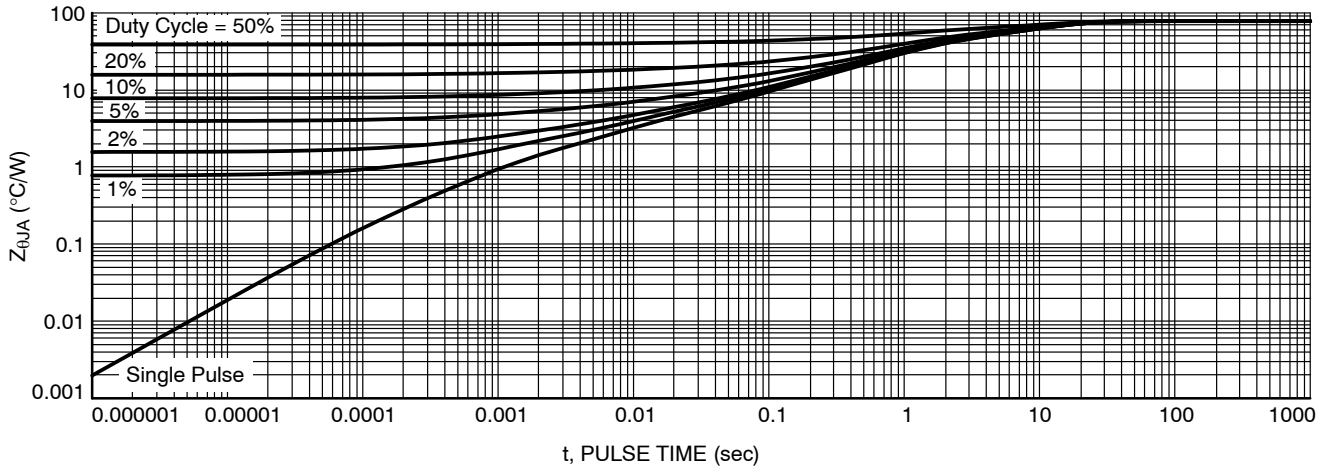

Figure 26. Thermal Response

# MECHANICAL CASE OUTLINE

## PACKAGE DIMENSIONS

ON Semiconductor®



**SOIC8**  
CASE 751EB  
ISSUE A

DATE 24 AUG 2017

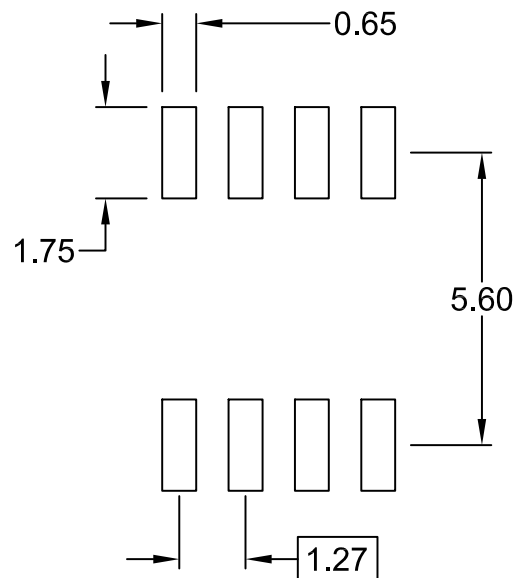
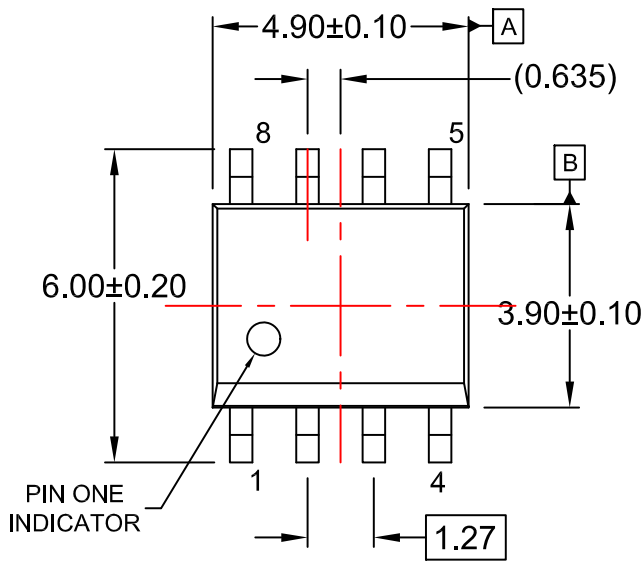

⊕ 0.25 (M) C B A

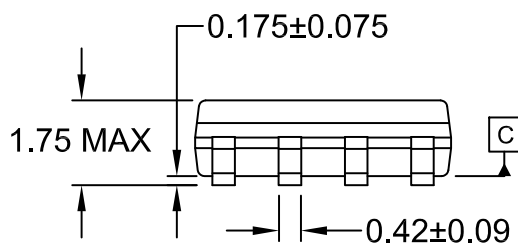

⌒ 0.10

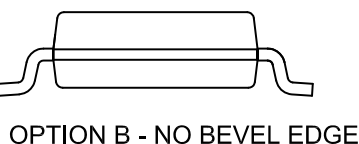
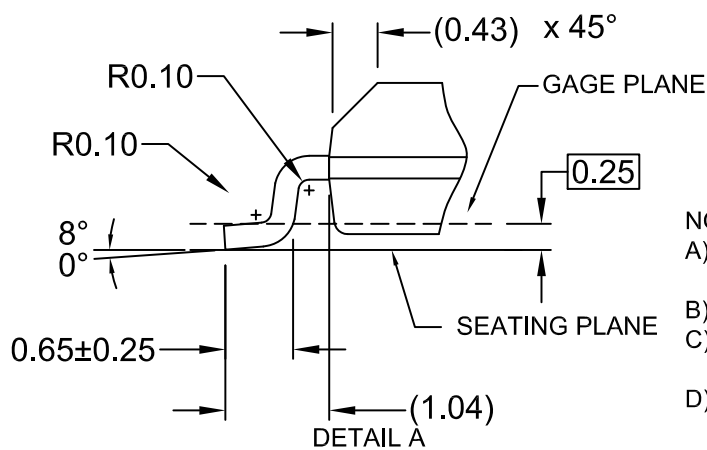
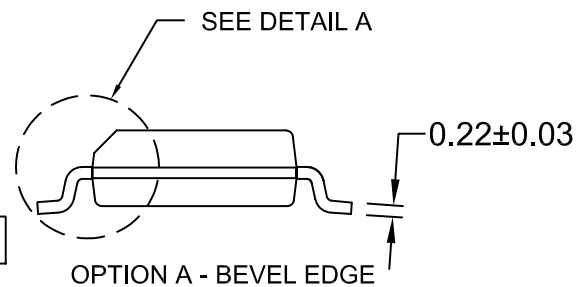

- NOTES:
- A) THIS PACKAGE CONFORMS TO JEDEC MS-012, VARIATION AA.
  - B) ALL DIMENSIONS ARE IN MILLIMETERS.
  - C) DIMENSIONS DO NOT INCLUDE MOLD FLASH OR BURRS.
  - D) LANDPATTERN STANDARD: SOIC127P600X175-8M

<b>DOCUMENT NUMBER:</b>	<b>98AON13735G</b>	Electronic versions are uncontrolled except when accessed directly from the Document Repository. Printed versions are uncontrolled except when stamped "CONTROLLED COPY" in red.
<b>DESCRIPTION:</b>	<b>SOIC8</b>	<b>PAGE 1 OF 1</b>

ON Semiconductor and are trademarks of Semiconductor Components Industries, LLC dba ON Semiconductor or its subsidiaries in the United States and/or other countries. ON Semiconductor reserves the right to make changes without further notice to any products herein. ON Semiconductor makes no warranty, representation or guarantee regarding the suitability of its products for any particular purpose, nor does ON Semiconductor assume any liability arising out of the application or use of any product or circuit, and specifically disclaims any and all liability, including without limitation special, consequential or incidental damages. ON Semiconductor does not convey any license under its patent rights nor the rights of others.

**onsemi**, **Onsemi**, and other names, marks, and brands are registered and/or common law trademarks of Semiconductor Components Industries, LLC dba "**onsemi**" or its affiliates and/or subsidiaries in the United States and/or other countries. **onsemi** owns the rights to a number of patents, trademarks, copyrights, trade secrets, and other intellectual property. A listing of **onsemi**'s product/patent coverage may be accessed at [www.onsemi.com/site/pdf/Patent-Marking.pdf](http://www.onsemi.com/site/pdf/Patent-Marking.pdf). **onsemi** reserves the right to make changes at any time to any products or information herein, without notice. The information herein is provided "as-is" and **onsemi** makes no warranty, representation or guarantee regarding the accuracy of the information, product features, availability, functionality, or suitability of its products for any particular purpose, nor does **onsemi** assume any liability arising out of the application or use of any product or circuit, and specifically disclaims any and all liability, including without limitation special, consequential or incidental damages. Buyer is responsible for its products and applications using **onsemi** products, including compliance with all laws, regulations and safety requirements or standards, regardless of any support or applications information provided by **onsemi**. "Typical" parameters which may be provided in **onsemi** data sheets and/or specifications can and do vary in different applications and actual performance may vary over time. All operating parameters, including "Typicals" must be validated for each customer application by customer's technical experts. **onsemi** does not convey any license under any of its intellectual property rights nor the rights of others. **onsemi** products are not designed, intended, or authorized for use as a critical component in life support systems or any FDA Class 3 medical devices or medical devices with a same or similar classification in a foreign jurisdiction or any devices intended for implantation in the human body. Should Buyer purchase or use **onsemi** products for any such unintended or unauthorized application, Buyer shall indemnify and hold **onsemi** and its officers, employees, subsidiaries, affiliates, and distributors harmless against all claims, costs, damages, and expenses, and reasonable attorney fees arising out of, directly or indirectly, any claim of personal injury or death associated with such unintended or unauthorized use, even if such claim alleges that **onsemi** was negligent regarding the design or manufacture of the part. **onsemi** is an Equal Opportunity/Affirmative Action Employer. This literature is subject to all applicable copyright laws and is not for resale in any manner.

## ADDITIONAL INFORMATION

### TECHNICAL PUBLICATIONS:

Technical Library: [www.onsemi.com/design/resources/technical-documentation](http://www.onsemi.com/design/resources/technical-documentation)  
onsemi Website: [www.onsemi.com](http://www.onsemi.com)

### ONLINE SUPPORT: [www.onsemi.com/support](http://www.onsemi.com/support)

For additional information, please contact your local Sales Representative at [www.onsemi.com/support/sales](http://www.onsemi.com/support/sales)

