

NTLJD2105L

Power MOSFET

8 V, 4.3 A, High Side Load Switch with Level Shift, 2x2 mm WDFN Package

Features

- WDFN 2x2 mm Package with Exposed Drain Pads Offers Excellent Thermal Performance
- Low $R_{DS(on)}$ P-Channel Load Switch with N-channel MOSFET for Level Shift
- N Channel Operated at 1.5 V Gate Drive Voltage Level
- P Channel Operated at 1.5 V Supply Voltage
- Same Footprint as SC88
- Low Profile (<0.8 mm) Allows it to Fit Easily into Extremely Thin Environments
- ESD Protection
- These are Pb-Free Devices

Applications

- High Side Load Switch with Level Shift
- Optimized for Power Management in Ultra Portable Equipment

MOSFET(Q2) MAXIMUM RATINGS

($T_J = 25^\circ\text{C}$ unless otherwise stated)

Parameter		Symbol	Value	Unit	
Q2 Input Voltage (V_{DS} , P-Channel)		V_{IN}	8	V	
Q1 On/Off Voltage (V_{GS} , N-Channel)		$V_{ON/OFF}$	6	V	
Continuous Load Current (Note 1)	Steady State	$T_A = 25^\circ\text{C}$	I_L	4.3	A
		$T_A = 85^\circ\text{C}$		3.1	
Power Dissipation (Note 1)	Steady State	$T_A = 25^\circ\text{C}$	P_D	1.56	W
Continuous Load Current (Note 2)	Steady State	$T_A = 25^\circ\text{C}$	I_L	2.5	A
		$T_A = 85^\circ\text{C}$		1.8	
Power Dissipation (Note 2)	Steady State	$T_A = 25^\circ\text{C}$	P_D	0.52	W
Pulsed Load Current	$t_p = 10 \mu\text{s}$	I_{LM}	20	A	
Operating Junction and Storage Temperature		T_J, T_{STG}	-55 to 150	$^\circ\text{C}$	
Source Current (Body Diode) (Note 2)		I_S	-2.7	A	
Lead Temperature for Soldering Purposes (1/8" from case for 10 s)		T_L	260	$^\circ\text{C}$	

Stresses exceeding those listed in the Maximum Ratings table may damage the device. If any of these limits are exceeded, device functionality should not be assumed, damage may occur and reliability may be affected.

1. Surface-mounted on FR4 board using 1 in sq pad size (Cu area = 1.127 in sq [2 oz] including traces)
2. Surface-mounted on FR4 board using the minimum recommended pad size.



ON Semiconductor®

www.onsemi.com

V_{INMAX}	$R_{DS(on)} MAX$	$I_L MAX$
20 V	50 m Ω @ 4.5 V	4.3 A
	60 m Ω @ 2.5 V	
	80 m Ω @ 1.8 V	
	115 m Ω @ 1.5 V	

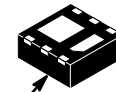
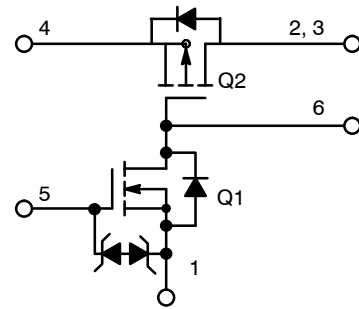

Pin 1

WDFN6
CASE 506AZ

MARKING DIAGRAM



JN = Specific Device Code

M = Date Code

■ = Pb-Free Package

(Note: Microdot may be in either location)

PIN CONNECTIONS

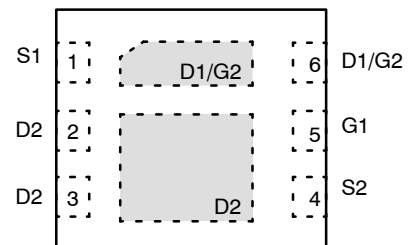

(Top View)

ORDERING INFORMATION

See detailed ordering and shipping information on page 5 of this data sheet.

NTLJD2105L

THERMAL RESISTANCE RATINGS

Parameter	Symbol	Max	Unit
Junction-to-Ambient – Steady State (Note 3)	$R_{\theta JA}$	80	$^{\circ}\text{C}/\text{W}$
Junction-to-Ambient – $t \leq 5$ s (Note 3)	$R_{\theta JA}$	38	$^{\circ}\text{C}/\text{W}$
Junction-to-Ambient – Steady State Min Pad (Note 4)	$R_{\theta JA}$	180	$^{\circ}\text{C}/\text{W}$

3. Surface Mounted on FR4 Board using 1 in sq pad size (Cu area = 1.127 in sq [2 oz] including traces).
 4. Surface-mounted on FR4 board using the minimum recommended pad size.

ELECTRICAL CHARACTERISTICS ($T_J = 25^{\circ}\text{C}$ unless otherwise specified)

Parameter	Symbol	Test Condition	Min	Typ	Max	Unit
-----------	--------	----------------	-----	-----	-----	------

OFF CHARACTERISTICS

Q2 Drain-to-Source Breakdown Voltage	$V_{(BR)DSS}$	$V_{GS} = 0$ V, $I_D = 250$ μA	-8.0			V
Q2 Forward Leakage Current	I_{FL}	$V_{ON/OFF} = 0$ V, $V_{IN} = 8.0$ V	$T_J = 25^{\circ}\text{C}$		0.1	μA
			$T_J = 85^{\circ}\text{C}$		1	
Q1 Gate-to-Source Leakage Current	I_{GSS}	$V_{DS} = 0$ V, $V_{GS1} = \pm 6$ V			± 100	nA
Q1 Diode Forward On-Voltage	V_{SD}	$I_S = -1.0$ A, $V_{GS1} = 0$ V		-0.8	-1.1	V

ON CHARACTERISTICS

Q1 ON/OFF Voltage	$V_{ON/OFF}$		1.5		8.0	
Q1 Gate Threshold Voltage	$V_{GS1(TH)}$	$V_{GS1} = V_{DS1}$, $I_D = 250$ μA	0.40		1.0	V
Q2 Input Voltage	V_{IN}		1.8		8.0	V
Q2 Drain-to-Source On Resistance	$R_{DS(on)}$	$V_{IN} = 4.5$ V, $I_L = 4.0$ A		33	50	m Ω
		$V_{IN} = 2.5$ V, $I_L = 3.0$ A		40	60	
		$V_{IN} = 1.8$ V, $I_L = 1.7$ A		60	80	
		$V_{IN} = 1.5$ V, $I_L = 1.2$ A		75	115	
Q2 Load Current	I_L	$V_{DROP} \leq 0.2$ V, $V_{IN} = 2.5$ V, $V_{ON/OFF} = 1.5$ V	1.0			A
		$V_{DROP} \leq 0.3$ V, $V_{IN} = 1.8$ V, $V_{ON/OFF} = 1.5$ V	1.0			

TYPICAL PERFORMANCE CURVES ($T_J = 25^\circ\text{C}$ unless otherwise noted)

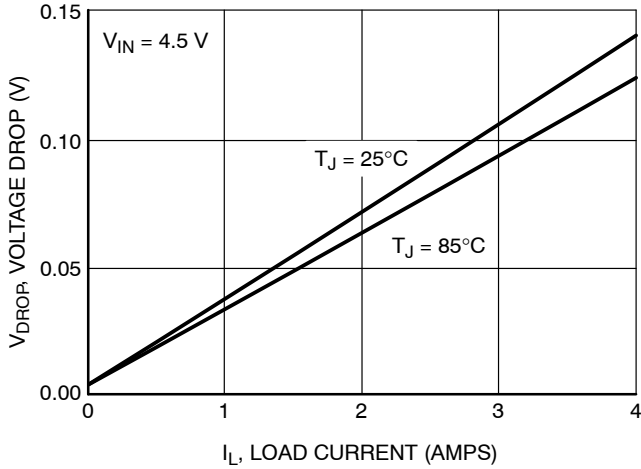

Figure 1. Voltage Drop versus Load Current @ $V_{IN} = 4.5\text{ V}$

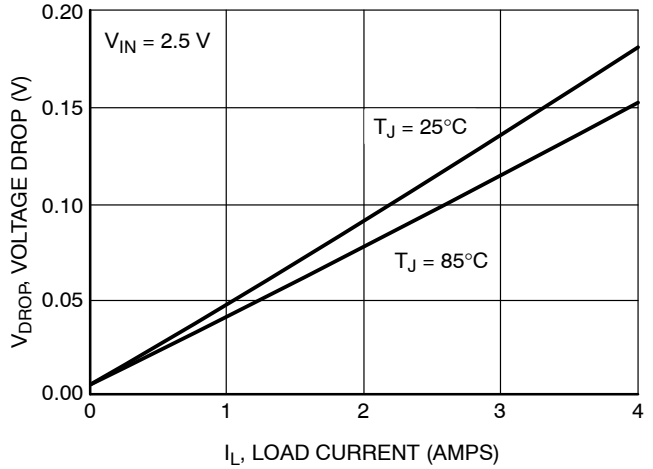

Figure 2. Voltage Drop versus Load Current @ $V_{IN} = 2.5\text{ V}$

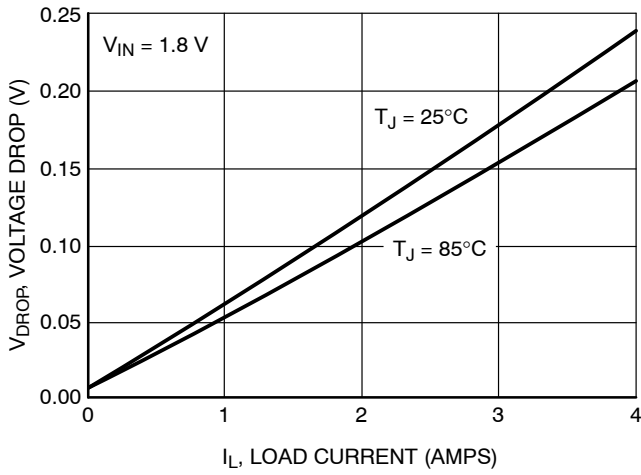

Figure 3. Voltage Drop versus Load Current @ $V_{IN} = 1.8\text{ V}$

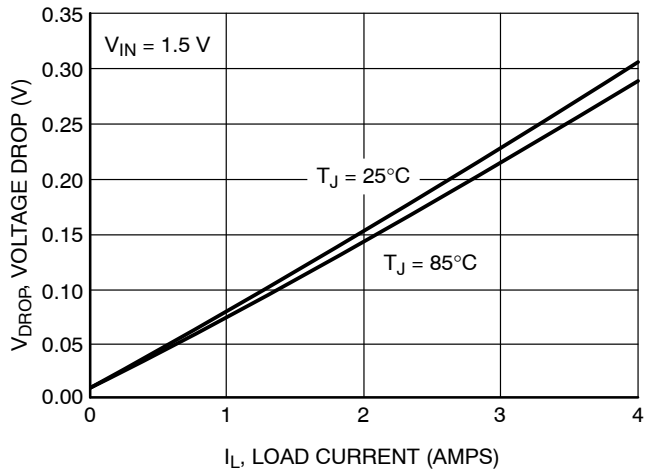

Figure 4. Voltage Drop versus Load Current @ $V_{IN} = 1.5\text{ V}$

NTLJD2105L

TYPICAL PERFORMANCE CURVES ($T_J = 25^\circ\text{C}$ unless otherwise noted)

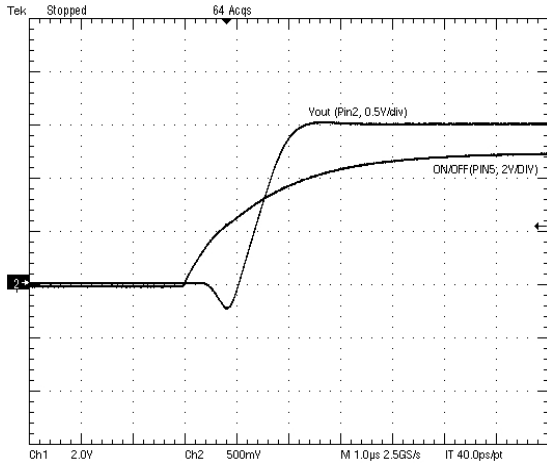

Figure 5. Turn-on
 $(V_{in} = 1.5\text{ V}, R_L = 3\ \Omega, R_1 = 1\ \text{k}\Omega, R_2 = 0, C_1 = 47\ \text{nF})$

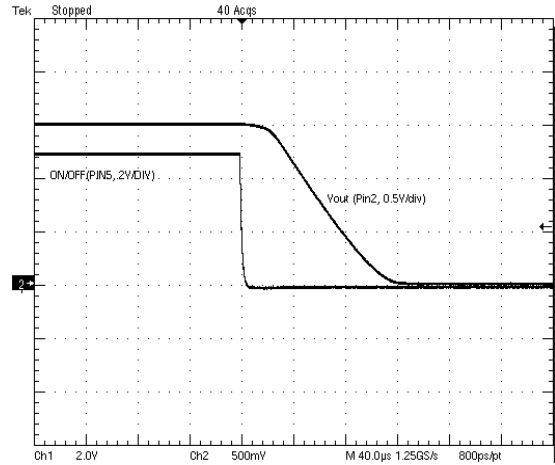

Figure 6. Turn-off
 $(V_{in} = 1.5\text{ V}, R_L = 3\ \Omega, R_1 = 1\ \text{k}\Omega, R_2 = 0, C_1 = 47\ \text{nF})$

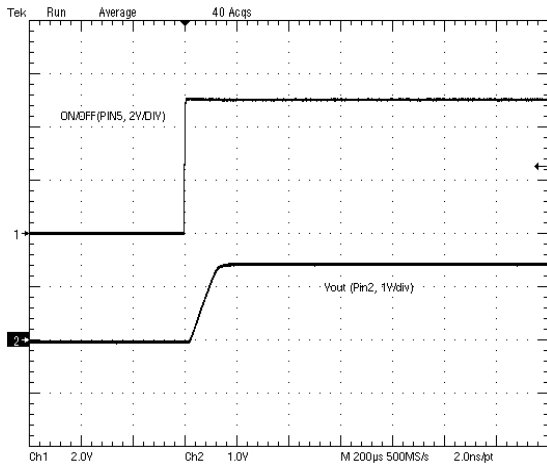

Figure 7. Turn-on
 $(V_{in} = 1.5\text{ V}, R_L = 3\ \Omega, R_1 = 10\ \text{k}\Omega, R_2 = 1\ \text{k}\Omega, C_1 = 47\ \text{nF})$

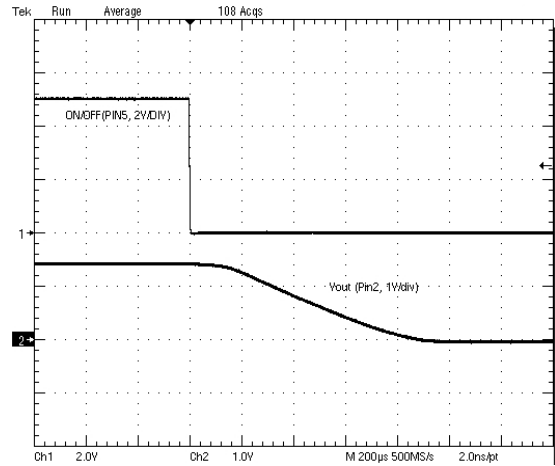

Figure 8. Turn-off
 $(V_{in} = 1.5\text{ V}, R_L = 3\ \Omega, R_1 = 10\ \text{k}\Omega, R_2 = 1\ \text{k}\Omega, C_1 = 47\ \text{nF})$

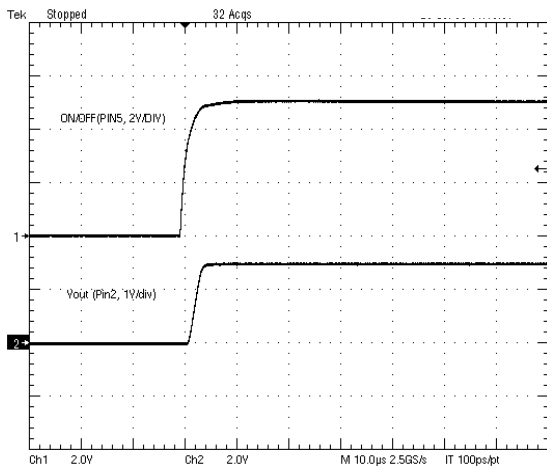

Figure 9. Turn-on
 $(V_{in} = 3\text{ V}, R_L = 3\ \Omega, R_1 = 10\ \text{k}\Omega, R_2 = 1\ \text{k}\Omega, C_1 = 47\ \text{nF})$

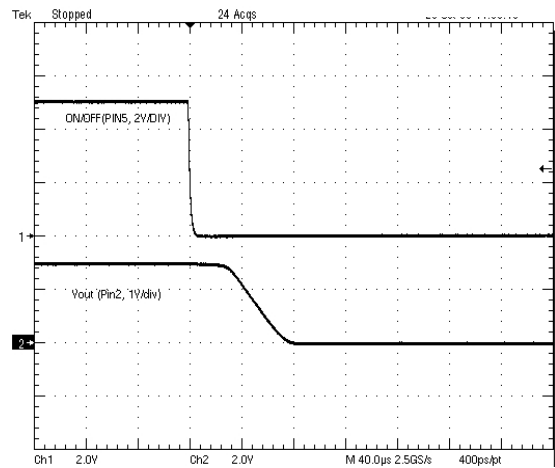

Figure 10. Turn-off
 $(V_{in} = 3\text{ V}, R_L = 3\ \Omega, R_1 = 10\ \text{k}\Omega, R_2 = 1\ \text{k}\Omega, C_1 = 47\ \text{nF})$

NTLJD2105L

TYPICAL PERFORMANCE CURVES ($T_J = 25^\circ\text{C}$ unless otherwise noted)

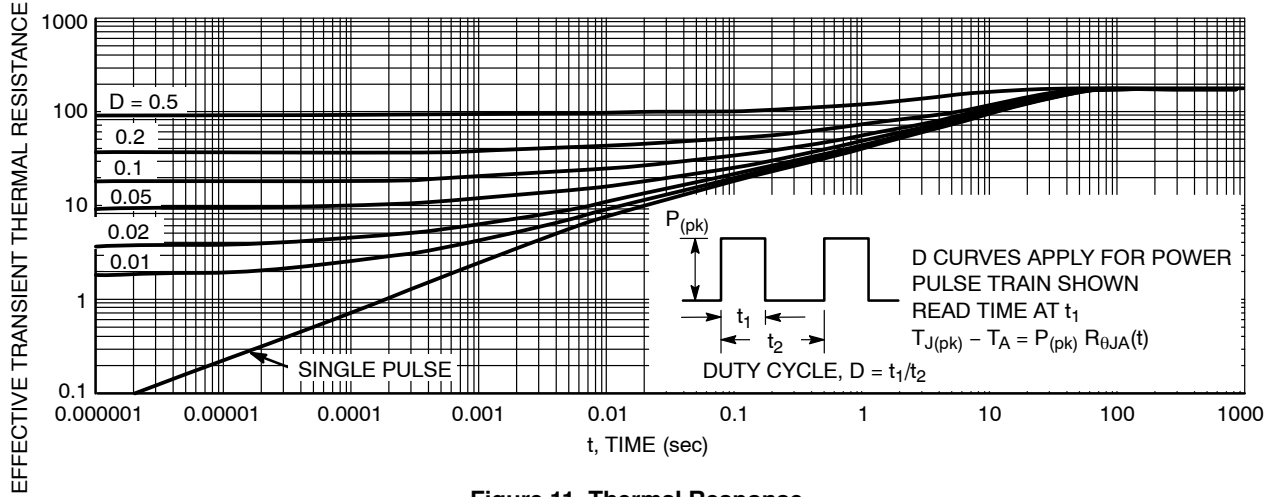

Figure 11. Thermal Response

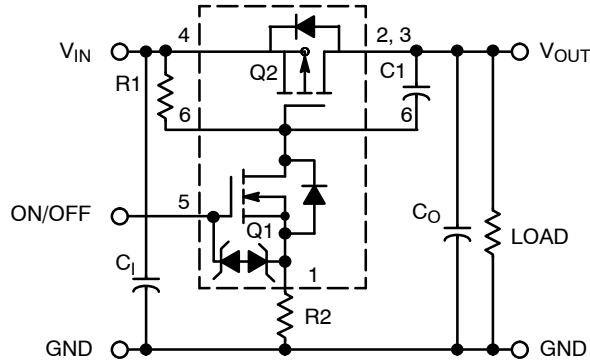

Figure 12. Load Switch Application

Components	Description	Value
R1	Pull-up Resistor	Typical 10 k Ω to 1.0 M Ω *
R2	Optional Slew-Rate Control	Typical 0 k Ω to 100 k Ω *
C_0, C_1	Output Capacitance	Usually < 1.0 μF
C1	Optional In-Rush Current Control	Typical \leq 1000 pF

*Minimum R1 value should be at least 10 x R2 to ensure Q1 turn-on.

ORDERING INFORMATION

Device	Package	Shipping [†]
NTLJD2105LTBG	WDFN6 (Pb-Free)	3000 / Tape & Reel

[†]For information on tape and reel specifications, including part orientation and tape sizes, please refer to our Tape and Reel Packaging Specifications Brochure, BRD8011/D.

MECHANICAL CASE OUTLINE PACKAGE DIMENSIONS

ON Semiconductor®

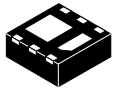

SCALE 4:1

WDFN6, 2x2
CASE 506AZ-01
ISSUE A

DATE 25 APR 2006

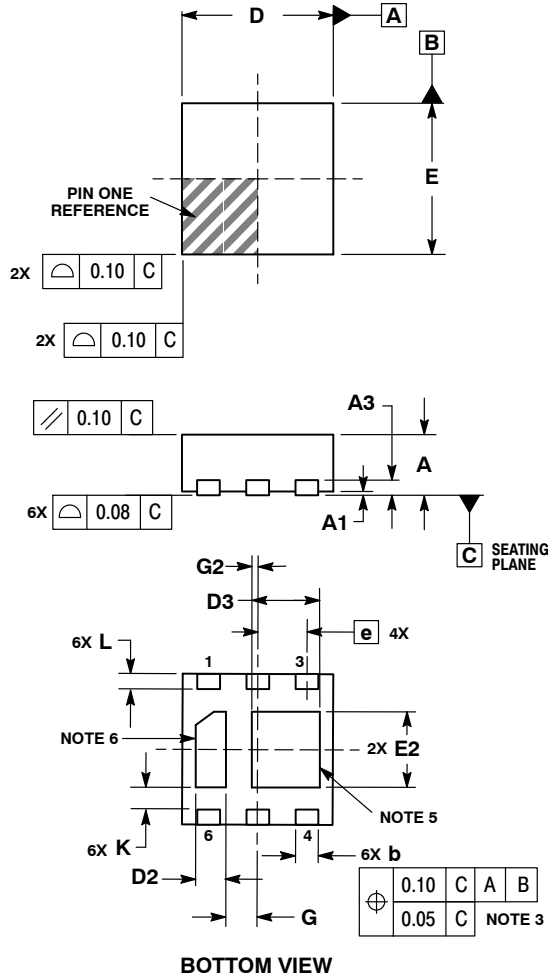

STYLE 1:
PIN 1. SOURCE 1
2. DRAIN 2
3. DRAIN 2
4. SOURCE 2
5. GATE 1
6. DRAIN 1

NOTES:

1. DIMENSIONING AND TOLERANCING PER ASME Y14.5M, 1994.
2. CONTROLLING DIMENSION: MILLIMETERS.
3. DIMENSION b APPLIES TO PLATED TERMINAL AND IS MEASURED BETWEEN 0.15 AND 0.20mm FROM TERMINAL.
4. COPLANARITY APPLIES TO THE EXPOSED PAD AS WELL AS THE TERMINALS.
 1. PINS 2 & 3 CONNECTED TO LARGE FLAG.
 2. PIN 6 CONNECTED TO SMALL FLAG.

DIM	MILLIMETERS	
	MIN	MAX
A	0.70	0.80
A1	0.00	0.05
A3	0.20 REF	
b	0.25	0.35
D	2.00 BSC	
D2	0.30	0.50
D3	0.80	1.00
E	2.00 BSC	
E2	0.90	1.10
e	0.65 BSC	
G	0.41 REF	
G2	0.085 REF	
K	0.25 REF	
L	0.20	0.30

GENERIC MARKING DIAGRAM*

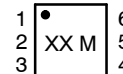

XX = Specific Device Code
M = Date Code

*This information is generic. Please refer to device data sheet for actual part marking. Pb-Free indicator, "G" or microdot "•", may or may not be present.

SOLDERMASK DEFINED MOUNTING FOOTPRINT

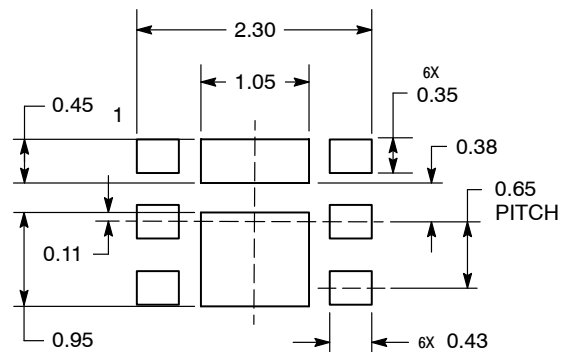

DIMENSIONS: MILLIMETERS

*For additional information on our Pb-Free strategy and soldering details, please download the ON Semiconductor Soldering and Mounting Techniques Reference Manual, SOLDERRM/D.

DOCUMENT NUMBER:	98AON22362D	Electronic versions are uncontrolled except when accessed directly from the Document Repository. Printed versions are uncontrolled except when stamped "CONTROLLED COPY" in red.
DESCRIPTION:	6 PIN WDFN 2X2, 0.65P	PAGE 1 OF 1

ON Semiconductor and ON are trademarks of Semiconductor Components Industries, LLC dba ON Semiconductor or its subsidiaries in the United States and/or other countries. ON Semiconductor reserves the right to make changes without further notice to any products herein. ON Semiconductor makes no warranty, representation or guarantee regarding the suitability of its products for any particular purpose, nor does ON Semiconductor assume any liability arising out of the application or use of any product or circuit, and specifically disclaims any and all liability, including without limitation special, consequential or incidental damages. ON Semiconductor does not convey any license under its patent rights nor the rights of others.

onsemi, **Onsemi**, and other names, marks, and brands are registered and/or common law trademarks of Semiconductor Components Industries, LLC dba "**onsemi**" or its affiliates and/or subsidiaries in the United States and/or other countries. **onsemi** owns the rights to a number of patents, trademarks, copyrights, trade secrets, and other intellectual property. A listing of **onsemi**'s product/patent coverage may be accessed at www.onsemi.com/site/pdf/Patent-Marking.pdf. **onsemi** reserves the right to make changes at any time to any products or information herein, without notice. The information herein is provided "as-is" and **onsemi** makes no warranty, representation or guarantee regarding the accuracy of the information, product features, availability, functionality, or suitability of its products for any particular purpose, nor does **onsemi** assume any liability arising out of the application or use of any product or circuit, and specifically disclaims any and all liability, including without limitation special, consequential or incidental damages. Buyer is responsible for its products and applications using **onsemi** products, including compliance with all laws, regulations and safety requirements or standards, regardless of any support or applications information provided by **onsemi**. "Typical" parameters which may be provided in **onsemi** data sheets and/or specifications can and do vary in different applications and actual performance may vary over time. All operating parameters, including "Typicals" must be validated for each customer application by customer's technical experts. **onsemi** does not convey any license under any of its intellectual property rights nor the rights of others. **onsemi** products are not designed, intended, or authorized for use as a critical component in life support systems or any FDA Class 3 medical devices or medical devices with a same or similar classification in a foreign jurisdiction or any devices intended for implantation in the human body. Should Buyer purchase or use **onsemi** products for any such unintended or unauthorized application, Buyer shall indemnify and hold **onsemi** and its officers, employees, subsidiaries, affiliates, and distributors harmless against all claims, costs, damages, and expenses, and reasonable attorney fees arising out of, directly or indirectly, any claim of personal injury or death associated with such unintended or unauthorized use, even if such claim alleges that **onsemi** was negligent regarding the design or manufacture of the part. **onsemi** is an Equal Opportunity/Affirmative Action Employer. This literature is subject to all applicable copyright laws and is not for resale in any manner.

ADDITIONAL INFORMATION

TECHNICAL PUBLICATIONS:

Technical Library: www.onsemi.com/design/resources/technical-documentation
onsemi Website: www.onsemi.com

ONLINE SUPPORT: www.onsemi.com/support

For additional information, please contact your local Sales Representative at www.onsemi.com/support/sales