

# NTLJD2104P

## Power MOSFET

-12 V, -4.3 A,  $\mu$ COOL™ Dual P-Channel, 2x2 mm, WDFN package

### Features

- WDFN 2x2 mm Package with Exposed Drain Pads for Excellent Thermal Conduction
- Lowest  $R_{DS(on)}$  in 2x2 mm Package
- Footprint Same as SC-88 Package
- Low Profile (<0.8 mm) for Easy Fit in Thin Environments
- Bidirectional Current Flow with Common Source Configuration
- These are Pb-Free Devices

### Applications

- Optimized for Battery and Load Management Applications in Portable Equipment
- Li Ion Battery Charging and Protection Circuits
- Dual High Side Load Switch

### MAXIMUM RATINGS ( $T_J = 25^\circ\text{C}$ unless otherwise noted)

Parameter		Symbol	Value	Unit
Drain-to-Source Voltage		$V_{DSS}$	-12	V
Gate-to-Source Voltage		$V_{GS}$	$\pm 8.0$	V
Continuous Drain Current (Note 1)	Steady State	$T_J = 25^\circ\text{C}$	-3.5	A
		$T_J = 85^\circ\text{C}$	-2.5	
	$t \leq 5$ s	$T_J = 25^\circ\text{C}$	-4.3	
Power Dissipation (Note 1)	Steady State	$T_J = 25^\circ\text{C}$	1.5	W
		$t \leq 5$ s	2.3	
Continuous Drain Current (Note 2)	Steady State	$T_J = 25^\circ\text{C}$	-2.4	A
		$T_J = 85^\circ\text{C}$	-1.7	
		$T_J = 25^\circ\text{C}$	0.7	
Power Dissipation (Note 2)		$P_D$	0.7	W
Pulsed Drain Current	$t_p = 10 \mu\text{s}$	$I_{DM}$	-20	A
Operating Junction and Storage Temperature		$T_J, T_{STG}$	-55 to 150	$^\circ\text{C}$
Source Current (Body Diode) (Note 2)		$I_S$	-1.5	A
Lead Temperature for Soldering Purposes (1/8" from case for 10 s)		$T_L$	260	$^\circ\text{C}$

Stresses exceeding Maximum Ratings may damage the device. Maximum Ratings are stress ratings only. Functional operation above the Recommended Operating Conditions is not implied. Extended exposure to stresses above the Recommended Operating Conditions may affect device reliability.

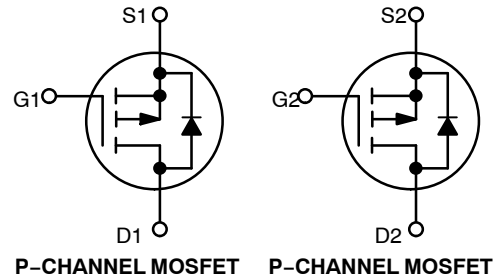
1. Surface Mounted on FR4 Board using 1 in sq pad size (Cu area = 1.127 in sq [2 oz] including traces).
2. Surface Mounted on FR4 Board using the minimum recommended pad size of 30 mm<sup>2</sup>, 2 oz. Cu.



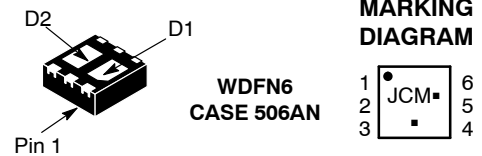
ON Semiconductor®

<http://onsemi.com>

$V_{(BR)DSS}$	$R_{DS(on)}$ TYP	$I_D$ MAX
-12 V	60 m $\Omega$ @ -4.5 V	-3.0 A
	85 m $\Omega$ @ -2.5 V	-3.0 A
	110 m $\Omega$ @ -1.8 V	-0.7 A
	140 m $\Omega$ @ -1.5 V	-0.5 A
	190 m $\Omega$ @ -1.3 V	-0.2 A
	230 m $\Omega$ @ -1.2 V	-0.2 A

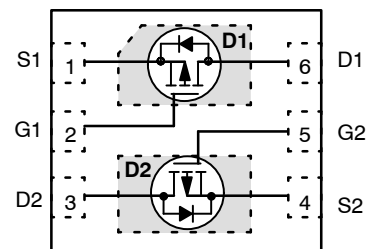


P-CHANNEL MOSFET P-CHANNEL MOSFET



JC = Specific Device Code  
M = Date Code  
■ = Pb-Free Package  
(Note: Microdot may be in either location)

### PIN CONNECTIONS



(Top View)

### ORDERING INFORMATION

See detailed ordering and shipping information in the package dimensions section on page 3 of this data sheet.

# NTLJD2104P

## THERMAL RESISTANCE RATINGS

Parameter	Symbol	Max	Unit
<b>SINGLE OPERATION (SELF-HEATED)</b>			
Junction-to-Ambient – Steady State (Note 3)	$R_{\theta JA}$	83	°C/W
Junction-to-Ambient – Steady State Min Pad (Note 4)	$R_{\theta JA}$	177	
Junction-to-Ambient – $t \leq 5$ s (Note 3)	$R_{\theta JA}$	54	
<b>DUAL OPERATION (EQUALLY HEATED)</b>			
Junction-to-Ambient – Steady State (Note 3)	$R_{\theta JA}$	58	°C/W
Junction-to-Ambient – Steady State Min Pad (Note 4)	$R_{\theta JA}$	133	
Junction-to-Ambient – $t \leq 5$ s (Note 3)	$R_{\theta JA}$	40	

- Surface Mounted on FR4 Board using 1 in sq pad size (Cu area = 1.127 in sq [2 oz] including traces).
- Surface Mounted on FR4 Board using the minimum recommended pad size (30 mm<sup>2</sup>, 2 oz Cu).

## MOSFET ELECTRICAL CHARACTERISTICS ( $T_J = 25^\circ\text{C}$ unless otherwise noted)

Parameter	Symbol	Test Conditions	Min	Typ	Max	Unit
<b>OFF CHARACTERISTICS</b>						
Drain-to-Source Breakdown Voltage	$V_{(BR)DSS}$	$V_{GS} = 0$ V, $I_D = -250$ $\mu\text{A}$	-12			V
Drain-to-Source Breakdown Voltage Temperature Coefficient	$V_{(BR)DSS}/T_J$	$I_D = -250$ $\mu\text{A}$ , Ref to $25^\circ\text{C}$		-7.0		mV/°C
Zero Gate Voltage Drain Current	$I_{DSS}$	$V_{DS} = -12$ V, $V_{GS} = 0$ V	$T_J = 25^\circ\text{C}$		-1.0	$\mu\text{A}$
			$T_J = 85^\circ\text{C}$		-10	
Gate-to-Source Leakage Current	$I_{GSS}$	$V_{DS} = 0$ V, $V_{GS} = \pm 8.0$ V			$\pm 100$	nA

## ON CHARACTERISTICS (Note 5)

Gate Threshold Voltage	$V_{GS(TH)}$	$V_{GS} = V_{DS}$ , $I_D = -250$ $\mu\text{A}$	-0.35	-0.6	-0.8	V
Gate Threshold Temperature Coefficient	$V_{GS(TH)}/T_J$			2.4		mV/°C
Drain-to-Source On-Resistance	$R_{DS(on)}$	$V_{GS} = -4.5$ V, $I_D = -3.0$ A		60	90	m $\Omega$
		$V_{GS} = -2.5$ V, $I_D = -3.0$ A		85	120	
		$V_{GS} = -1.8$ V, $I_D = -0.7$ A		110	150	
		$V_{GS} = -1.5$ V, $I_D = -0.5$ A		140	200	
		$V_{GS} = -1.3$ V, $I_D = -0.2$ A		190		
Forward Transconductance	$g_{FS}$	$V_{DS} = -10$ V, $I_D = -3.0$ A		6.0		S

## CHARGES, CAPACITANCES AND GATE RESISTANCE

Input Capacitance	$C_{ISS}$	$V_{GS} = 0$ V, $f = 1.0$ MHz, $V_{DS} = -6.0$ V		467		pF
Output Capacitance	$C_{OSS}$			125		
Reverse Transfer Capacitance	$C_{RSS}$			79		
Total Gate Charge	$Q_{G(TOT)}$	$V_{GS} = -4.5$ V, $V_{DS} = -6.0$ V, $I_D = -3.0$ A		5.5	8.0	nC
Threshold Gate Charge	$Q_{G(TH)}$			0.3		
Gate-to-Source Charge	$Q_{GS}$			0.8		
Gate-to-Drain Charge	$Q_{GD}$			1.5		
Gate Resistance	$R_G$			12.2		$\Omega$

- Pulse Test: Pulse Width  $\leq 300$   $\mu\text{s}$ , Duty Cycle  $\leq 2\%$ .
- Switching characteristics are independent of operating junction temperatures.

# NTLJD2104P

## MOSFET ELECTRICAL CHARACTERISTICS ( $T_J = 25^\circ\text{C}$ unless otherwise noted)

Parameter	Symbol	Test Conditions	Min	Typ	Max	Unit
<b>SWITCHING CHARACTERISTICS</b> (Note 6)						
Turn-On Delay Time	$t_{d(ON)}$	$V_{GS} = -4.5\text{ V}, V_{DD} = -6.0\text{ V},$ $I_D = -3.0\text{ A}, R_G = 2.0\ \Omega$		6.6		ns
Rise Time	$t_r$			12.3		
Turn-Off Delay Time	$t_{d(OFF)}$			14		
Fall Time	$t_f$			16.2		

## DRAIN-SOURCE DIODE CHARACTERISTICS

Forward Recovery Voltage	$V_{SD}$	$V_{GS} = 0\text{ V}, I_S = -1.0\text{ A}$	$T_J = 25^\circ\text{C}$		-0.7	-1.0	V
			$T_J = 85^\circ\text{C}$		-0.65		
Reverse Recovery Time	$t_{RR}$	$V_{GS} = 0\text{ V}, d_{ISD}/d_t = 100\text{ A}/\mu\text{s},$ $I_S = -1.0\text{ A}$		23	45	ns	
Charge Time	$t_a$			8.0			
Discharge Time	$t_b$			15			
Reverse Recovery Time	$Q_{RR}$			10	20		nC

5. Pulse Test: Pulse Width  $\leq 300\ \mu\text{s}$ , Duty Cycle  $\leq 2\%$ .

6. Switching characteristics are independent of operating junction temperatures.

## ORDERING INFORMATION

Device	Package	Shipping <sup>†</sup>
NTLJD2104PTBG	WDFN6 (Pb-Free)	3000 / Tape & Reel
NTLJD2104PTAG	WDFN6 (Pb-Free)	3000 / Tape & Reel

<sup>†</sup>For information on tape and reel specifications, including part orientation and tape sizes, please refer to our Tape and Reel Packaging Specifications Brochure, BRD8011/D.

TYPICAL CHARACTERISTICS

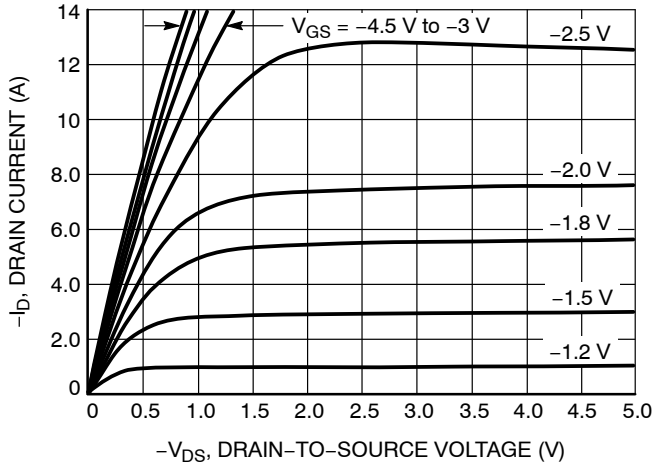


Figure 1. On-Region Characteristics

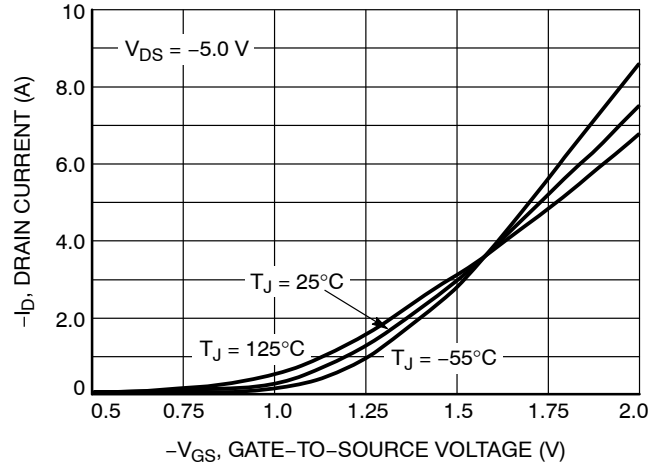


Figure 2. Transfer Characteristics

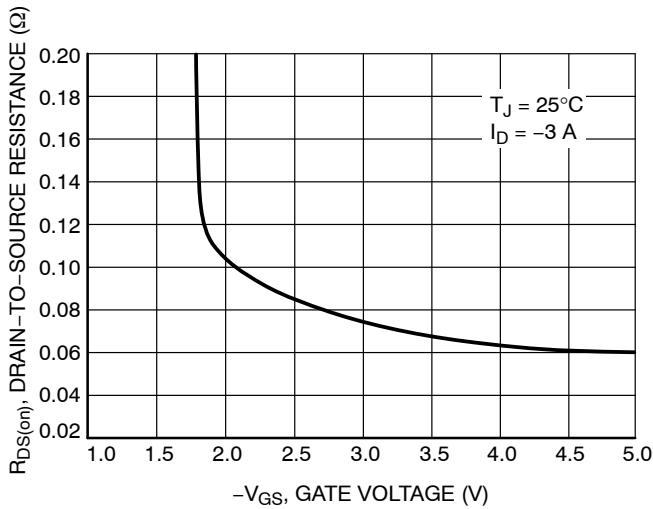


Figure 3. On-Resistance vs. Gate-to-Source Voltage

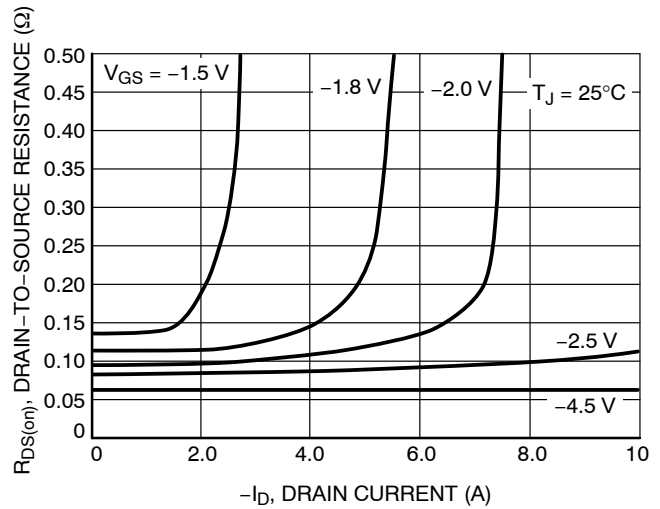


Figure 4. On-Resistance vs. Drain Current and Gate Voltage

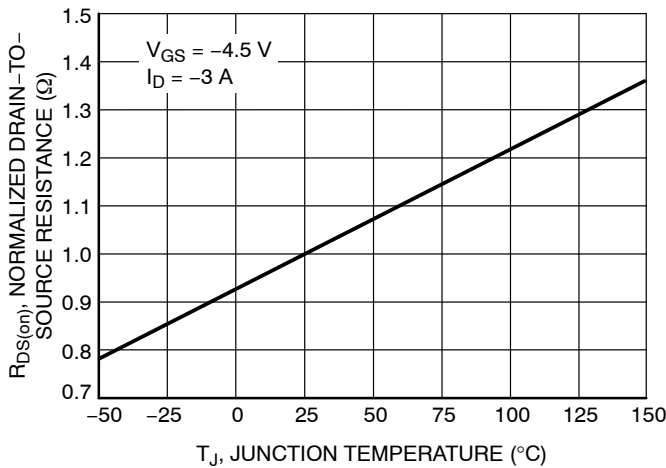


Figure 5. On-Resistance Variation with Temperature

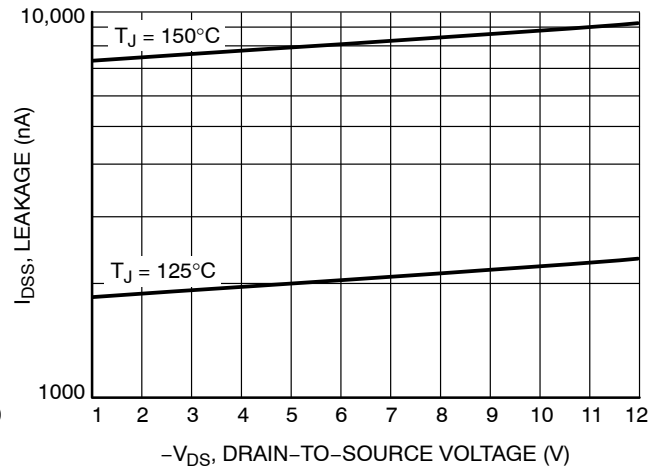


Figure 6. Drain-to-Source Leakage Current vs. Voltage

TYPICAL CHARACTERISTICS

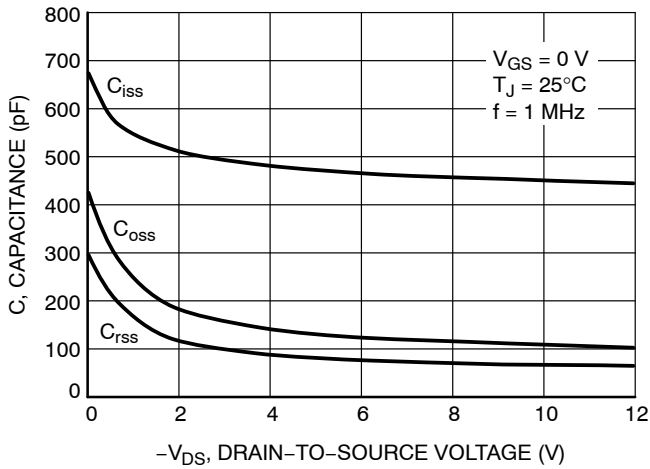


Figure 7. Capacitance Variation

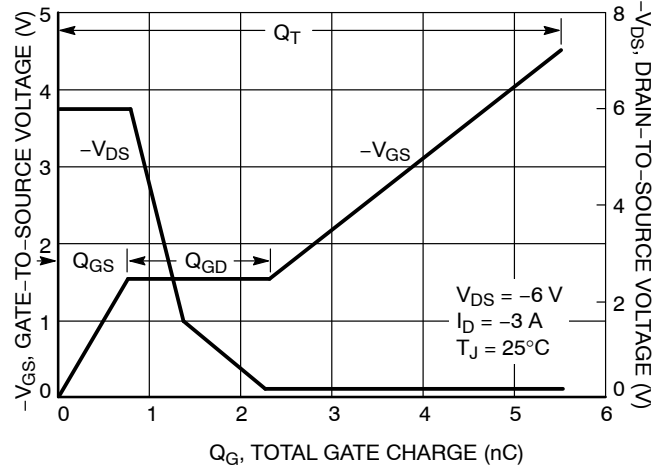


Figure 8. Gate-to-Source and Drain-to-Source Voltage vs. Total Charge

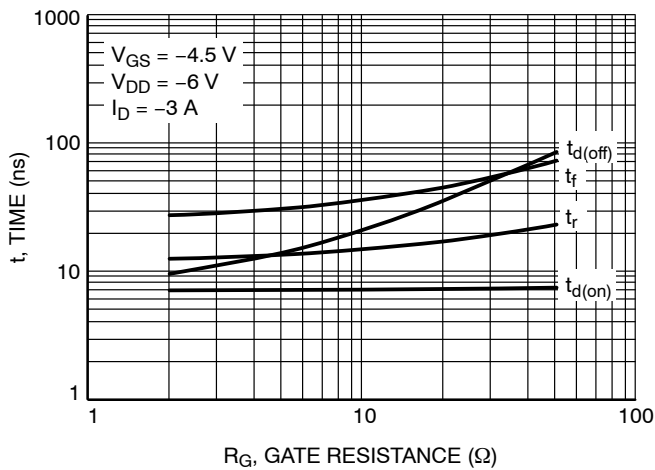


Figure 9. Resistive Switching Time Variation vs. Gate Resistance

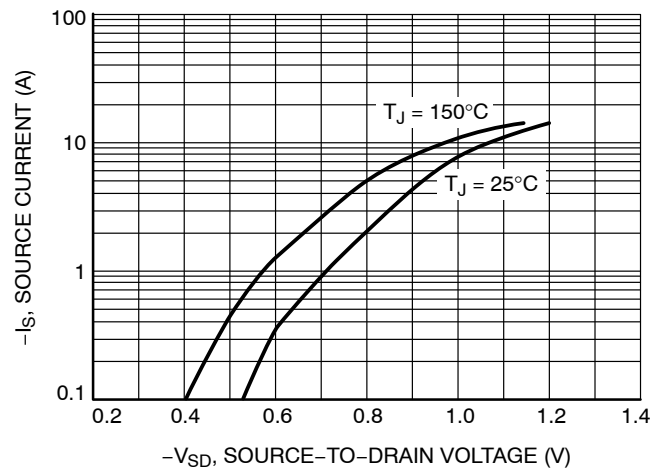


Figure 10. Diode Forward Voltage vs. Current

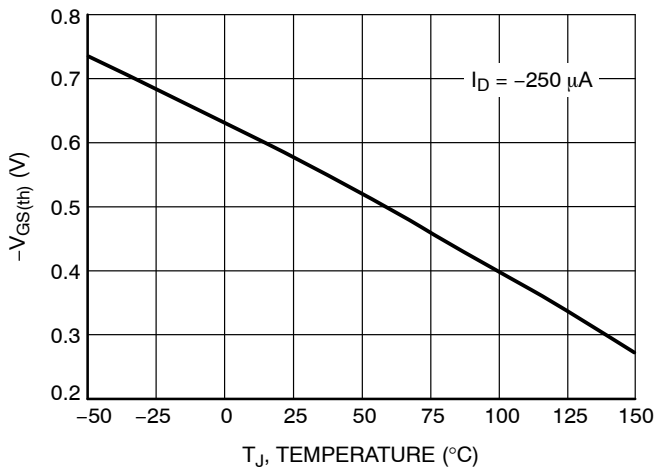


Figure 11. Threshold Voltage

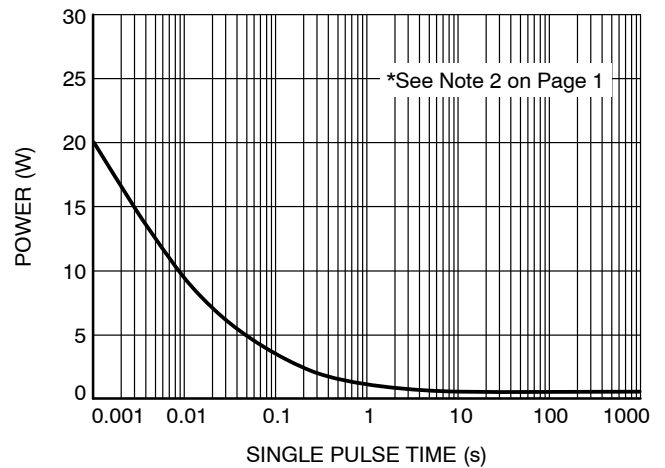
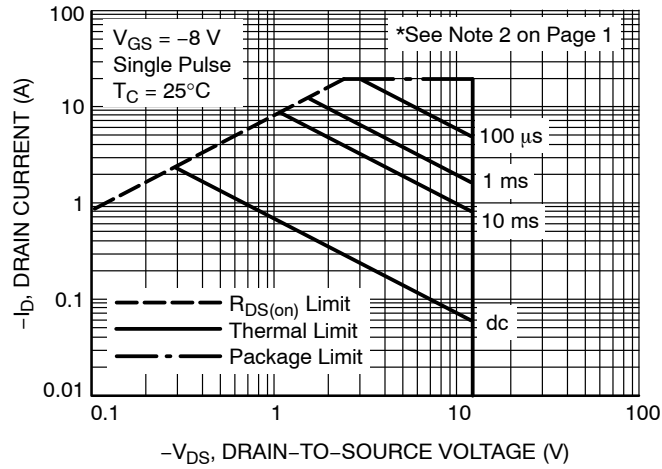


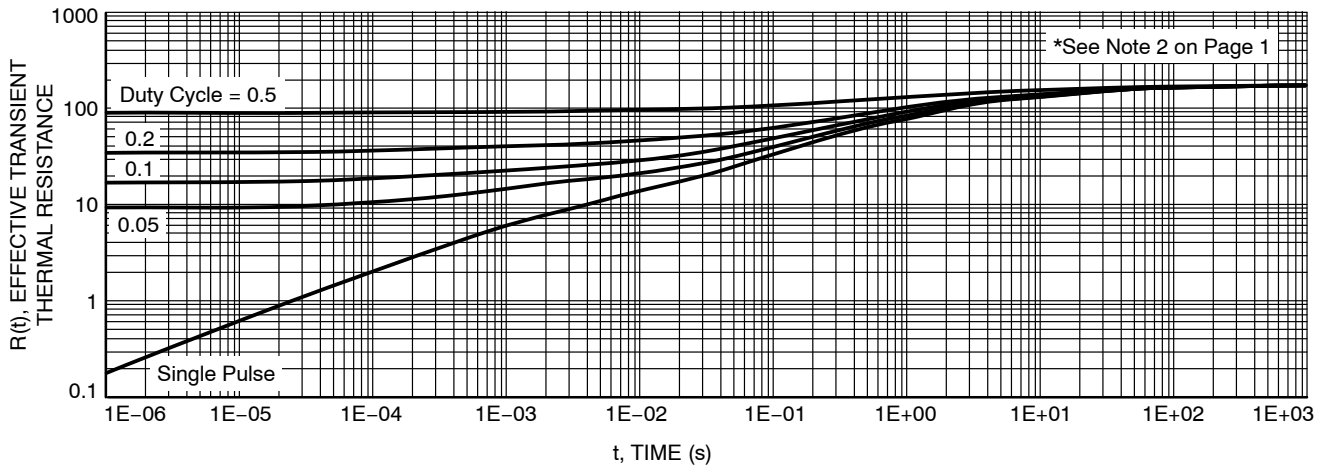
Figure 12. Single Pulse Maximum Power Dissipation

# NTLJD2104P

## TYPICAL CHARACTERISTICS

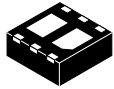


**Figure 13. Maximum Rated Forward Biased Safe Operating Area**



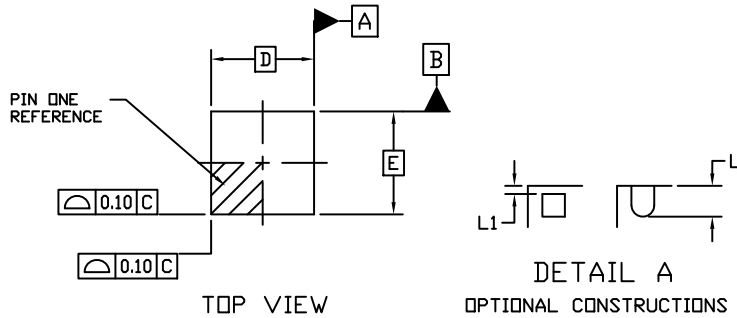
**Figure 14. FET Thermal Response**

# MECHANICAL CASE OUTLINE PACKAGE DIMENSIONS



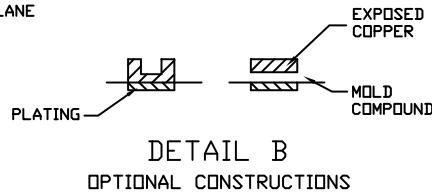
WDFN6 2x2, 0.65P  
CASE 506AN  
ISSUE H

DATE 25 JAN 2022

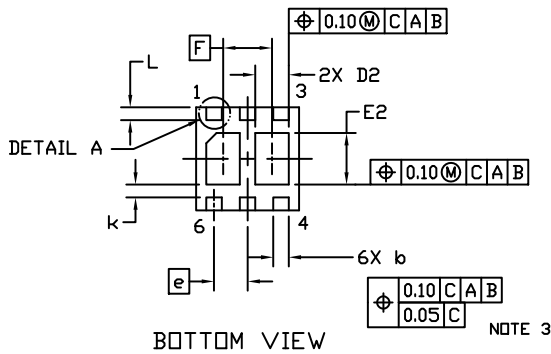


NOTES:

1. DIMENSIONING AND TOLERANCING PER ASME Y14.5M, 1994.
2. CONTROLLING DIMENSION: MILLIMETERS
3. DIMENSION *b* APPLIES TO PLATED TERMINAL AND IS MEASURED BETWEEN 0.15 AND 0.30 MM FROM THE TERMINAL TIP.
4. COPLANARITY APPLIES TO THE EXPOSED PADS AS WELL AS THE TERMINALS.



DIM	MILLIMETERS	
	MIN.	MAX.
A	0.70	0.80
A1	0.00	0.05
A3	0.20 REF	
<i>b</i>	0.25	0.35
D	2.00 BSC	
D2	0.57	0.77
E	2.00 BSC	
E2	0.90	1.10
<i>e</i>	0.65 BSC	
F	0.95 BSC	
<i>k</i>	0.25 REF	
L	0.20	0.30
L1	---	0.10

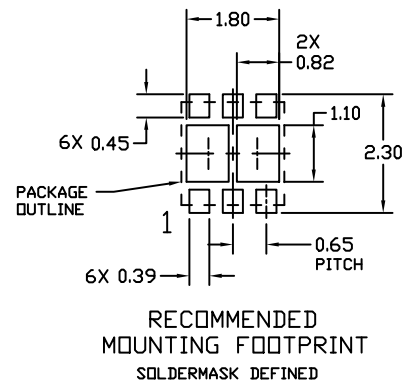


GENERIC MARKING DIAGRAM\*



XX = Specific Device Code  
M = Date Code

\*This information is generic. Please refer to device data sheet for actual part marking. Pb-Free indicator, "G" or microdot "▪", may or may not be present. Some products may not follow the Generic Marking.



DOCUMENT NUMBER:	98AON20861D	Electronic versions are uncontrolled except when accessed directly from the Document Repository. Printed versions are uncontrolled except when stamped "CONTROLLED COPY" in red.
DESCRIPTION:	WDFN6 2x2, 0.65P	PAGE 1 OF 1

onsemi and ONSEMI are trademarks of Semiconductor Components Industries, LLC dba onsemi or its subsidiaries in the United States and/or other countries. onsemi reserves the right to make changes without further notice to any products herein. onsemi makes no warranty, representation or guarantee regarding the suitability of its products for any particular purpose, nor does onsemi assume any liability arising out of the application or use of any product or circuit, and specifically disclaims any and all liability, including without limitation special, consequential or incidental damages. onsemi does not convey any license under its patent rights nor the rights of others.

**onsemi**, **Onsemi**, and other names, marks, and brands are registered and/or common law trademarks of Semiconductor Components Industries, LLC dba "**onsemi**" or its affiliates and/or subsidiaries in the United States and/or other countries. **onsemi** owns the rights to a number of patents, trademarks, copyrights, trade secrets, and other intellectual property. A listing of **onsemi**'s product/patent coverage may be accessed at [www.onsemi.com/site/pdf/Patent-Marking.pdf](http://www.onsemi.com/site/pdf/Patent-Marking.pdf). **onsemi** reserves the right to make changes at any time to any products or information herein, without notice. The information herein is provided "as-is" and **onsemi** makes no warranty, representation or guarantee regarding the accuracy of the information, product features, availability, functionality, or suitability of its products for any particular purpose, nor does **onsemi** assume any liability arising out of the application or use of any product or circuit, and specifically disclaims any and all liability, including without limitation special, consequential or incidental damages. Buyer is responsible for its products and applications using **onsemi** products, including compliance with all laws, regulations and safety requirements or standards, regardless of any support or applications information provided by **onsemi**. "Typical" parameters which may be provided in **onsemi** data sheets and/or specifications can and do vary in different applications and actual performance may vary over time. All operating parameters, including "Typicals" must be validated for each customer application by customer's technical experts. **onsemi** does not convey any license under any of its intellectual property rights nor the rights of others. **onsemi** products are not designed, intended, or authorized for use as a critical component in life support systems or any FDA Class 3 medical devices or medical devices with a same or similar classification in a foreign jurisdiction or any devices intended for implantation in the human body. Should Buyer purchase or use **onsemi** products for any such unintended or unauthorized application, Buyer shall indemnify and hold **onsemi** and its officers, employees, subsidiaries, affiliates, and distributors harmless against all claims, costs, damages, and expenses, and reasonable attorney fees arising out of, directly or indirectly, any claim of personal injury or death associated with such unintended or unauthorized use, even if such claim alleges that **onsemi** was negligent regarding the design or manufacture of the part. **onsemi** is an Equal Opportunity/Affirmative Action Employer. This literature is subject to all applicable copyright laws and is not for resale in any manner.

## ADDITIONAL INFORMATION

### TECHNICAL PUBLICATIONS:

Technical Library: [www.onsemi.com/design/resources/technical-documentation](http://www.onsemi.com/design/resources/technical-documentation)  
onsemi Website: [www.onsemi.com](http://www.onsemi.com)

### ONLINE SUPPORT: [www.onsemi.com/support](http://www.onsemi.com/support)

For additional information, please contact your local Sales Representative at [www.onsemi.com/support/sales](http://www.onsemi.com/support/sales)