

NTD5867NL

MOSFET – Power, N-Channel 60 V, 20 A, 39 mΩ

Features

- Low $R_{DS(on)}$
- High Current Capability
- 100% Avalanche Tested
- These Devices are Pb-Free, Halogen Free/BFR Free and are RoHS Compliant

MAXIMUM RATINGS ($T_J = 25^\circ\text{C}$ unless otherwise noted)

| Parameter | Symbol | Value | Unit | |
|---|------------------------|---------------------------|------------------|---|
| Drain-to-Source Voltage | V_{DS} | 60 | V | |
| Gate-to-Source Voltage – Continuous | V_{GS} | ± 20 | V | |
| Gate-to-Source Voltage – Non-Repetitive ($t_p < 10 \mu\text{s}$) | V_{GS} | ± 30 | V | |
| Continuous Drain Current ($R_{\theta JC}$) | Steady State | $T_C = 25^\circ\text{C}$ | I_D 20 | A |
| | | $T_C = 100^\circ\text{C}$ | 13 | |
| Power Dissipation ($R_{\theta JC}$) | | $T_C = 25^\circ\text{C}$ | P_D 36 | W |
| Pulsed Drain Current | $t_p = 10 \mu\text{s}$ | I_{DM} | 76 | A |
| Operating Junction and Storage Temperature | T_J, T_{stg} | -55 to 150 | $^\circ\text{C}$ | |
| Source Current (Body Diode) | I_S | 20 | A | |
| Single Pulse Drain-to-Source Avalanche Energy ($V_{DD} = 50 \text{ V}, V_{GS} = 10 \text{ V}, R_G = 25 \Omega, I_{L(pk)} = 19 \text{ A}, L = 0.1 \text{ mH}, T_J = 25^\circ\text{C}$) | E_{AS} | 18 | mJ | |
| Lead Temperature for Soldering Purposes (1/8" from case for 10 s) | T_L | 260 | $^\circ\text{C}$ | |

Stresses exceeding those listed in the Maximum Ratings table may damage the device. If any of these limits are exceeded, device functionality should not be assumed, damage may occur and reliability may be affected.

THERMAL RESISTANCE MAXIMUM RATINGS

| Parameter | Symbol | Value | Unit |
|---|-----------------|-------|--------------------|
| Junction-to-Case (Drain) | $R_{\theta JC}$ | 3.5 | $^\circ\text{C/W}$ |
| Junction-to-Ambient – Steady State (Note 1) | $R_{\theta JA}$ | 45 | |

1. Surface-mounted on FR4 board using 1 in sq pad size (Cu area = 1.127 in sq [2 oz] including traces).



ON Semiconductor®

<http://onsemi.com>

| $V_{(BR)DSS}$ | $R_{DS(on)}$ MAX | I_D MAX |
|---------------|------------------|-----------|
| 60 V | 39 mΩ @ 10 V | 20 A |
| | 50 mΩ @ 4.5 V | 18 A |

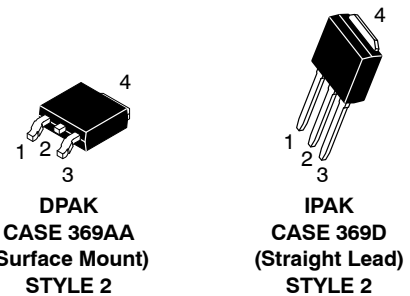
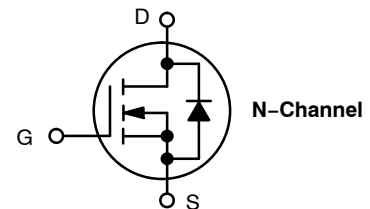

MARKING DIAGRAMS & PIN ASSIGNMENT

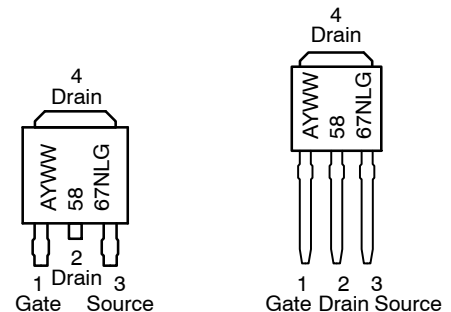

- A = Assembly Location*
- Y = Year
- WW = Work Week
- 5867NL = Device Code
- G = Pb-Free Package

* The Assembly Location code (A) is front side optional. In cases where the Assembly Location is stamped in the package, the front side assembly code may be blank.

ORDERING INFORMATION

See detailed ordering and shipping information on page 5 of this data sheet.

NTD5867NL

ELECTRICAL CHARACTERISTICS ($T_J = 25^\circ\text{C}$ unless otherwise noted)

| Parameter | Symbol | Test Condition | Min | Typ | Max | Unit |
|-----------|--------|----------------|-----|-----|-----|------|
|-----------|--------|----------------|-----|-----|-----|------|

OFF CHARACTERISTICS

| | | | | | | |
|---|-------------------|---|---------------------------|----|-----------|----------------------------|
| Drain-to-Source Breakdown Voltage | $V_{(BR)DSS}$ | $V_{GS} = 0\text{ V}, I_D = 250\ \mu\text{A}$ | 60 | | | V |
| Drain-to-Source Breakdown Voltage Temperature Coefficient | $V_{(BR)DSS}/T_J$ | | | 60 | | $\text{mV}/^\circ\text{C}$ |
| Zero Gate Voltage Drain Current | I_{DSS} | $V_{GS} = 0\text{ V}, V_{DS} = 60\text{ V}$ | $T_J = 25^\circ\text{C}$ | | 1.0 | μA |
| | | | $T_J = 125^\circ\text{C}$ | | 100 | |
| Gate-to-Source Leakage Current | I_{GSS} | $V_{DS} = 0\text{ V}, V_{GS} = \pm 20\text{ V}$ | | | ± 100 | nA |

ON CHARACTERISTICS (Note 2)

| | | | | | | |
|--|------------------|--|-----|-----|-----|----------------------------|
| Gate Threshold Voltage | $V_{GS(TH)}$ | $V_{GS} = V_{DS}, I_D = 250\ \mu\text{A}$ | 1.5 | 1.8 | 2.5 | V |
| Negative Threshold Temperature Coefficient | $V_{GS(TH)}/T_J$ | | | 5.2 | | $\text{mV}/^\circ\text{C}$ |
| Drain-to-Source On Resistance | $R_{DS(on)}$ | $V_{GS} = 10\text{ V}, I_D = 10\text{ A}$ | | 26 | 39 | $\text{m}\Omega$ |
| | | $V_{GS} = 4.5\text{ V}, I_D = 10\text{ A}$ | | 33 | 50 | |
| Forward Transconductance | g_{FS} | $V_{DS} = 15\text{ V}, I_D = 10\text{ A}$ | | 8.0 | | S |

CHARGES, CAPACITANCES AND GATE RESISTANCES

| | | | | | | |
|------------------------------|--------------|--|--|-----|--|-------------|
| Input Capacitance | C_{iss} | $V_{GS} = 0\text{ V}, f = 1.0\text{ MHz}, V_{DS} = 25\text{ V}$ | | 675 | | pF |
| Output Capacitance | C_{oss} | | | 68 | | |
| Reverse Transfer Capacitance | C_{rss} | | | 47 | | |
| Total Gate Charge | $Q_{G(TOT)}$ | $V_{GS} = 10\text{ V}, V_{DS} = 48\text{ V}, I_D = 20\text{ A}$ | | 15 | | nC |
| Threshold Gate Charge | $Q_{G(TH)}$ | | | 1.0 | | |
| Gate-to-Source Charge | Q_{GS} | | | 2.2 | | |
| Gate-to-Drain Charge | Q_{GD} | | | 4.3 | | |
| Total Gate Charge | $Q_{G(TOT)}$ | $V_{GS} = 4.5\text{ V}, V_{DS} = 48\text{ V}, I_D = 20\text{ A}$ | | 7.6 | | nC |
| Gate Resistance | R_G | | | 1.3 | | Ω |

SWITCHING CHARACTERISTICS (Note 3)

| | | | | | | |
|---------------------|--------------|--|--|------|--|-------------|
| Turn-On Delay Time | $t_{d(on)}$ | $V_{GS} = 10\text{ V}, V_{DD} = 48\text{ V}, I_D = 20\text{ A}, R_G = 2.5\ \Omega$ | | 6.5 | | ns |
| Rise Time | t_r | | | 12.6 | | |
| Turn-Off Delay Time | $t_{d(off)}$ | | | 18.2 | | |
| Fall Time | t_f | | | 2.4 | | |

DRAIN-SOURCE DIODE CHARACTERISTICS

| | | | | | | | |
|-------------------------|----------|--|---------------------------|-----|------|-------------|-------------|
| Forward Diode Voltage | V_{SD} | $V_{GS} = 0\text{ V}, I_S = 10\text{ A}$ | $T_J = 25^\circ\text{C}$ | | 0.87 | 1.2 | V |
| | | | $T_J = 100^\circ\text{C}$ | | 0.78 | | |
| Reverse Recovery Time | t_{RR} | $V_{GS} = 0\text{ V}, dI_S/dt = 100\text{ A}/\mu\text{s}, I_S = 20\text{ A}$ | | 17 | | ns | |
| Charge Time | t_a | | | 13 | | | |
| Discharge Time | t_b | | | 4.0 | | | |
| Reverse Recovery Charge | Q_{RR} | | | 12 | | | nC |

Product parametric performance is indicated in the Electrical Characteristics for the listed test conditions, unless otherwise noted. Product performance may not be indicated by the Electrical Characteristics if operated under different conditions.

2. Pulse Test: Pulse Width $\leq 300\ \mu\text{s}$, Duty Cycle $\leq 2\%$.

3. Switching characteristics are independent of operating junction temperatures.

TYPICAL PERFORMANCE CURVES

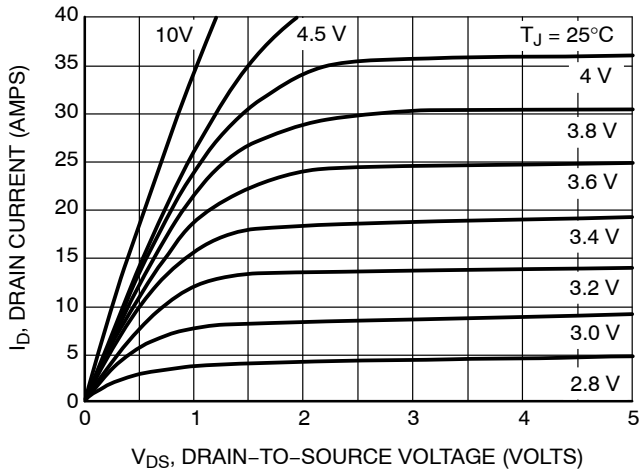

Figure 1. On-Region Characteristics

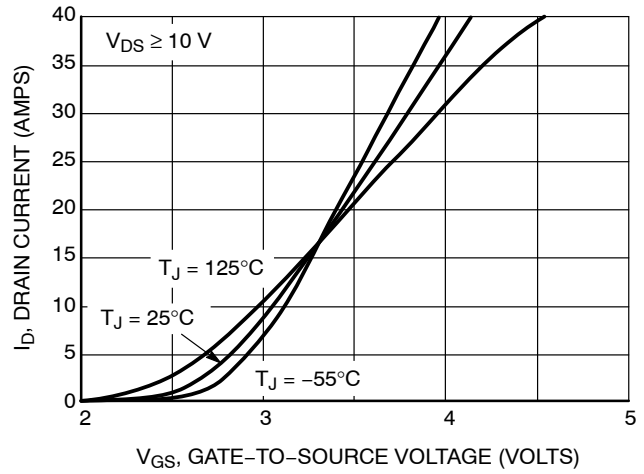

Figure 2. Transfer Characteristics

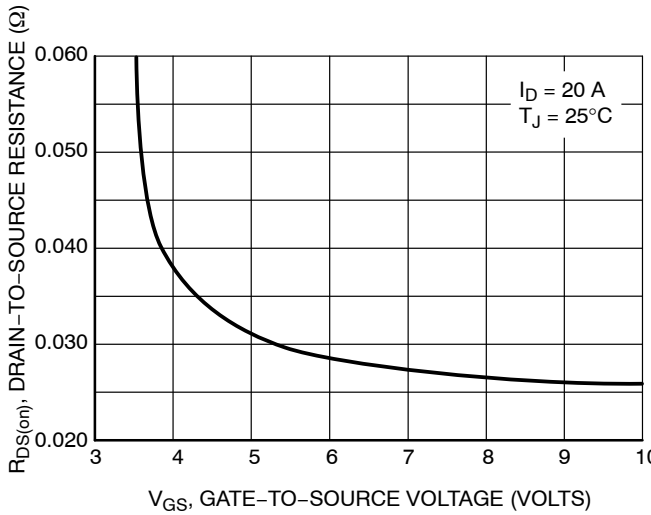

Figure 3. On-Resistance vs. Gate-to-Source Voltage

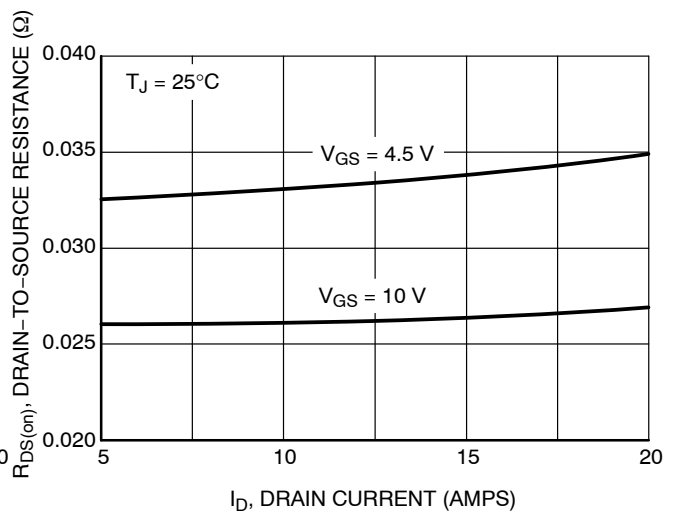

Figure 4. On-Resistance vs. Drain Current and Gate Voltage

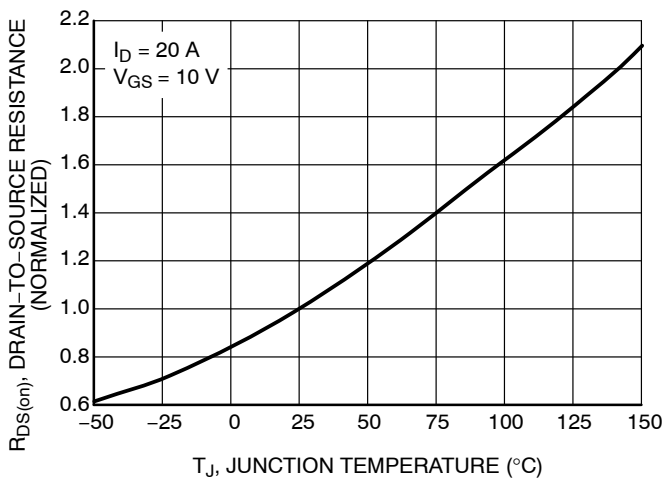

Figure 5. On-Resistance Variation with Temperature

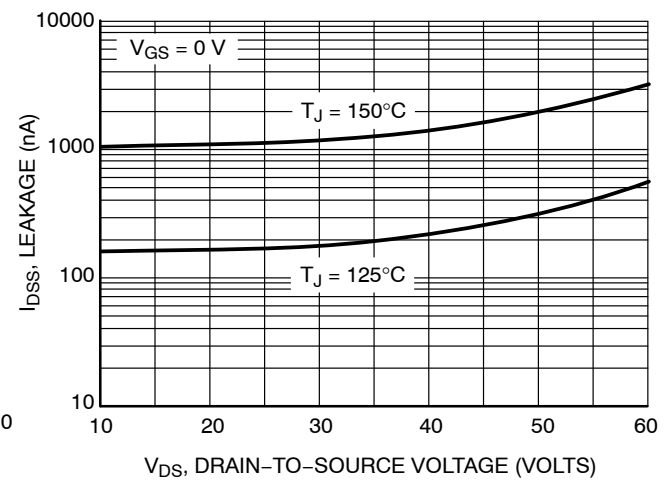

Figure 6. Drain-to-Source Leakage Current vs. Drain Voltage

TYPICAL PERFORMANCE CURVES

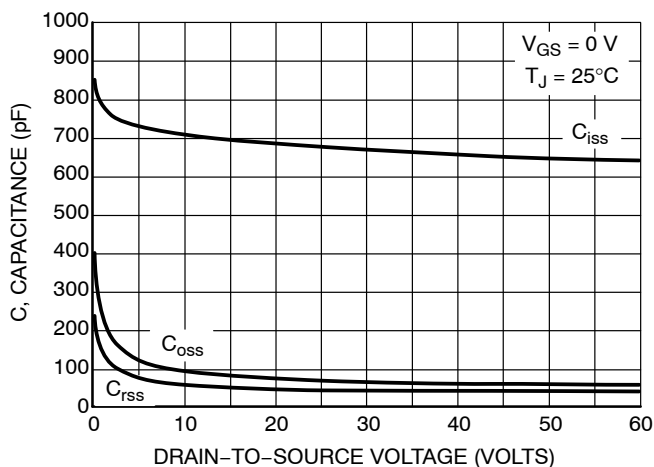

Figure 7. Capacitance Variation

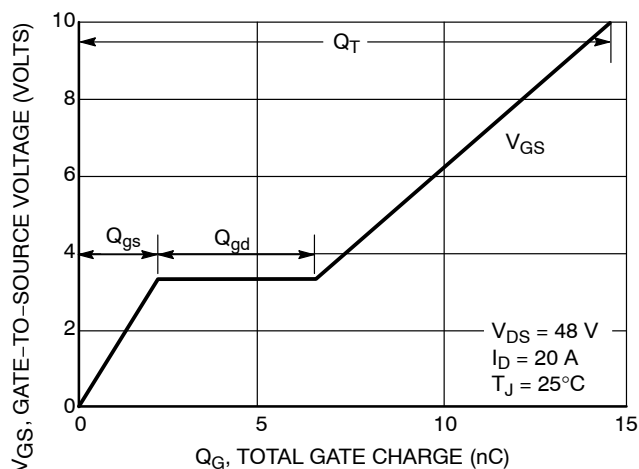

Figure 8. Gate-To-Source Voltage vs. Total Charge

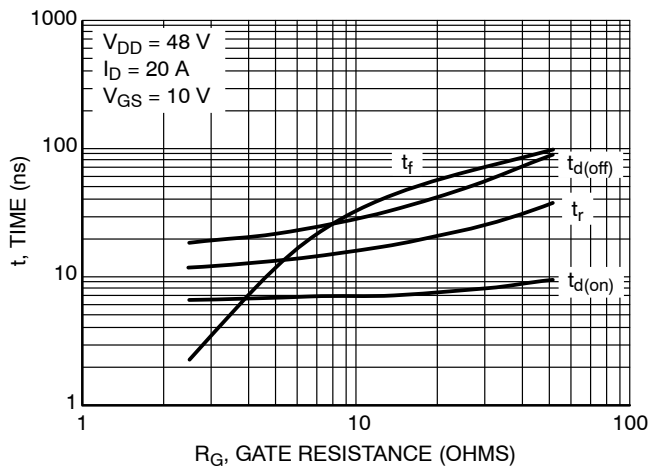

Figure 9. Resistive Switching Time Variation vs. Gate Resistance

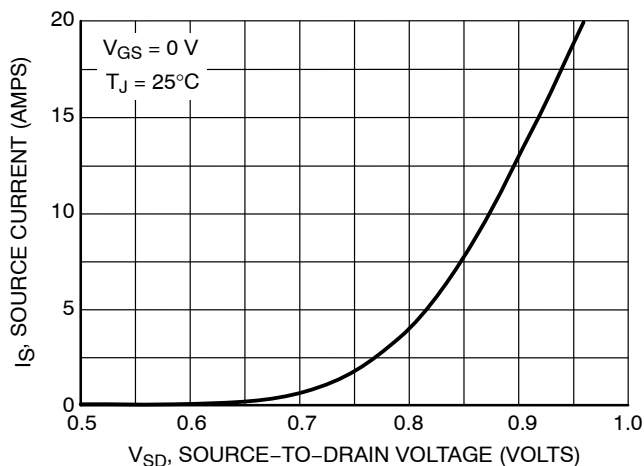

Figure 10. Diode Forward Voltage vs. Current

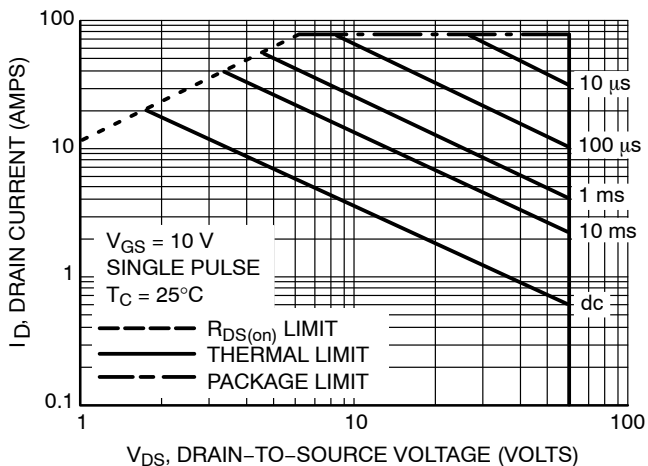

Figure 11. Maximum Rated Forward Biased Safe Operating Area

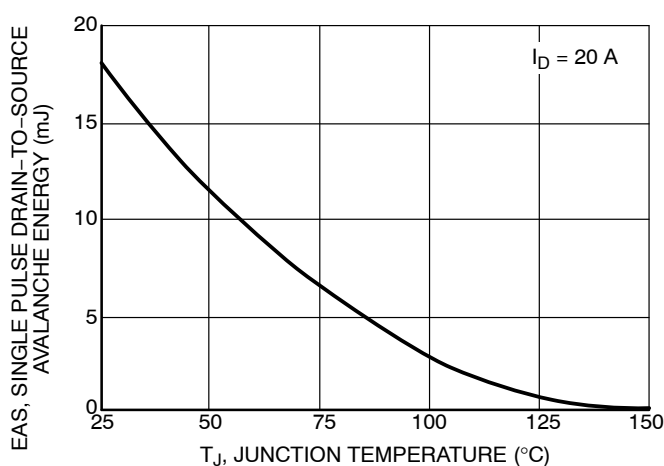

Figure 12. Maximum Avalanche Energy vs. Starting Junction Temperature

NTD5867NL

TYPICAL PERFORMANCE CURVES

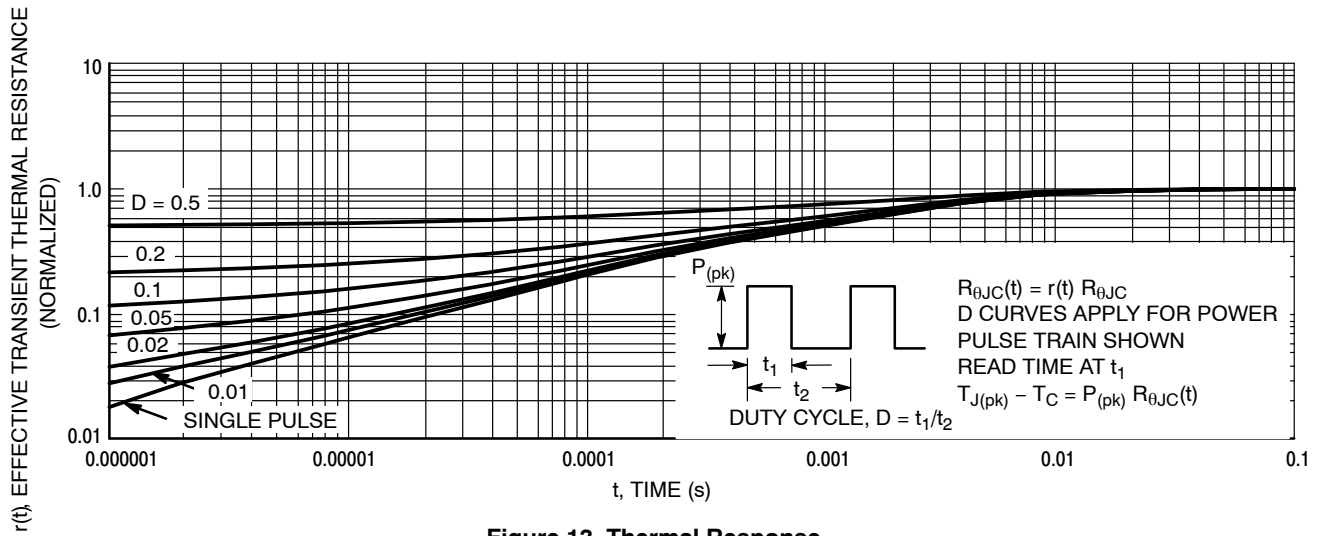

Figure 13. Thermal Response

ORDERING INFORMATION

| Order Number | Package | Shipping [†] |
|--------------|-----------------------------------|-----------------------|
| NTD5867NL-1G | IPAK (Straight Lead) (Pb-Free) | 75 Units / Rail |
| NTD5867NLT4G | DPAK (Pb-Free) | 2500 / Tape & Reel |

[†]For information on tape and reel specifications, including part orientation and tape sizes, please refer to our Tape and Reel Packaging Specifications Brochure, BRD8011/D.

MECHANICAL CASE OUTLINE

PACKAGE DIMENSIONS

ON Semiconductor®



IPAK CASE 369D-01 ISSUE C

DATE 15 DEC 2010

SCALE 1:1

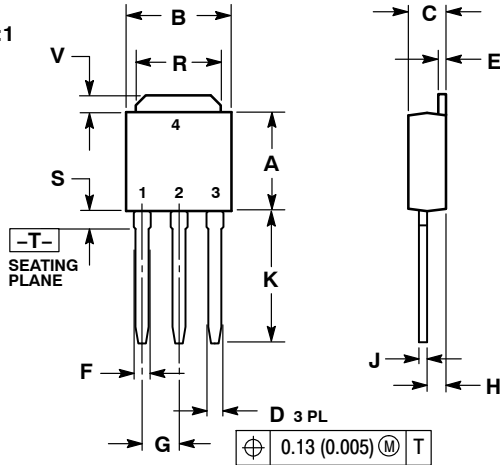

- NOTES:
1. DIMENSIONING AND TOLERANCING PER ANSI Y14.5M, 1982.
 2. CONTROLLING DIMENSION: INCH.

| DIM | INCHES | | MILLIMETERS | |
|-----|--------|-------|-------------|------|
| | MIN | MAX | MIN | MAX |
| A | 0.235 | 0.245 | 5.97 | 6.35 |
| B | 0.250 | 0.265 | 6.35 | 6.73 |
| C | 0.086 | 0.094 | 2.19 | 2.38 |
| D | 0.027 | 0.035 | 0.69 | 0.88 |
| E | 0.018 | 0.023 | 0.46 | 0.58 |
| F | 0.037 | 0.045 | 0.94 | 1.14 |
| G | 0.090 | BSC | 2.29 | BSC |
| H | 0.034 | 0.040 | 0.87 | 1.01 |
| J | 0.018 | 0.023 | 0.46 | 0.58 |
| K | 0.350 | 0.380 | 8.89 | 9.65 |
| R | 0.180 | 0.215 | 4.45 | 5.45 |
| S | 0.025 | 0.040 | 0.63 | 1.01 |
| V | 0.035 | 0.050 | 0.89 | 1.27 |
| Z | 0.155 | --- | 3.93 | --- |

- | | | | |
|--|---|--|--|
| <p>STYLE 1: PIN 1. BASE 2. COLLECTOR 3. EMITTER 4. COLLECTOR</p> | <p>STYLE 2: PIN 1. GATE 2. DRAIN 3. SOURCE 4. DRAIN</p> | <p>STYLE 3: PIN 1. ANODE 2. CATHODE 3. ANODE 4. CATHODE</p> | <p>STYLE 4: PIN 1. CATHODE 2. ANODE 3. GATE 4. ANODE</p> |
| <p>STYLE 5: PIN 1. GATE 2. ANODE 3. CATHODE 4. ANODE</p> | <p>STYLE 6: PIN 1. MT1 2. MT2 3. GATE 4. MT2</p> | <p>STYLE 7: PIN 1. GATE 2. COLLECTOR 3. EMITTER 4. COLLECTOR</p> | |

MARKING DIAGRAMS

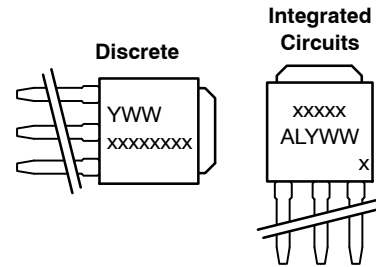

- xxxxxxxx = Device Code
A = Assembly Location
IL = Wafer Lot
Y = Year
WW = Work Week

| | | |
|-------------------------|------------------------------------|--|
| DOCUMENT NUMBER: | 98AON10528D | Electronic versions are uncontrolled except when accessed directly from the Document Repository. Printed versions are uncontrolled except when stamped "CONTROLLED COPY" in red. |
| DESCRIPTION: | IPAK (DPAK INSERTION MOUNT) | PAGE 1 OF 1 |

ON Semiconductor and are trademarks of Semiconductor Components Industries, LLC dba ON Semiconductor or its subsidiaries in the United States and/or other countries. ON Semiconductor reserves the right to make changes without further notice to any products herein. ON Semiconductor makes no warranty, representation or guarantee regarding the suitability of its products for any particular purpose, nor does ON Semiconductor assume any liability arising out of the application or use of any product or circuit, and specifically disclaims any and all liability, including without limitation special, consequential or incidental damages. ON Semiconductor does not convey any license under its patent rights nor the rights of others.

MECHANICAL CASE OUTLINE

PACKAGE DIMENSIONS

ON Semiconductor®

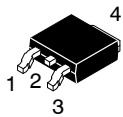

SCALE 1:1

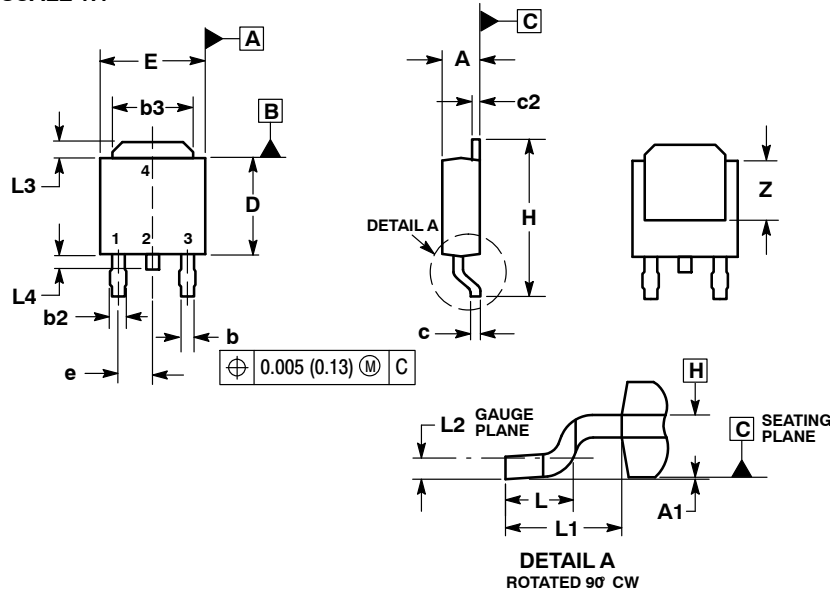

DPAK (SINGLE GAUGE)

CASE 369AA-01

ISSUE B

DATE 03 JUN 2010

NOTES:

- DIMENSIONING AND TOLERANCING PER ASME Y14.5M, 1994.
- CONTROLLING DIMENSION: INCHES.
- THERMAL PAD CONTOUR OPTIONAL WITHIN DIMENSIONS b3, L3 and Z.
- DIMENSIONS D AND E DO NOT INCLUDE MOLD FLASH, PROTRUSIONS, OR BURRS. MOLD FLASH, PROTRUSIONS, OR GATE BURRS SHALL NOT EXCEED 0.006 INCHES PER SIDE.
- DIMENSIONS D AND E ARE DETERMINED AT THE OUTERMOST EXTREMES OF THE PLASTIC BODY.
- DATUMS A AND B ARE DETERMINED AT DATUM PLANE H.

| DIM | INCHES | | MILLIMETERS | |
|-----|-----------|-------|-------------|-------|
| | MIN | MAX | MIN | MAX |
| A | 0.086 | 0.094 | 2.18 | 2.38 |
| A1 | 0.000 | 0.005 | 0.00 | 0.13 |
| b | 0.025 | 0.035 | 0.63 | 0.89 |
| b2 | 0.030 | 0.045 | 0.76 | 1.14 |
| b3 | 0.180 | 0.215 | 4.57 | 5.46 |
| c | 0.018 | 0.024 | 0.46 | 0.61 |
| c2 | 0.018 | 0.024 | 0.46 | 0.61 |
| D | 0.235 | 0.245 | 5.97 | 6.22 |
| E | 0.250 | 0.265 | 6.35 | 6.73 |
| e | 0.090 BSC | | 2.29 BSC | |
| H | 0.370 | 0.410 | 9.40 | 10.41 |
| L | 0.055 | 0.070 | 1.40 | 1.78 |
| L1 | 0.108 REF | | 2.74 REF | |
| L2 | 0.020 BSC | | 0.51 BSC | |
| L3 | 0.035 | 0.050 | 0.89 | 1.27 |
| L4 | --- | 0.040 | --- | 1.01 |
| Z | 0.155 | --- | 3.93 | --- |

- | | | | |
|--|---|--|--|
| <p>STYLE 1: PIN 1. BASE 2. COLLECTOR 3. EMITTER 4. COLLECTOR</p> | <p>STYLE 2: PIN 1. GATE 2. DRAIN 3. SOURCE 4. DRAIN</p> | <p>STYLE 3: PIN 1. ANODE 2. CATHODE 3. ANODE 4. CATHODE</p> | <p>STYLE 4: PIN 1. CATHODE 2. ANODE 3. GATE 4. ANODE</p> |
| <p>STYLE 5: PIN 1. GATE 2. ANODE 3. CATHODE 4. ANODE</p> | <p>STYLE 6: PIN 1. MT1 2. MT2 3. GATE 4. MT2</p> | <p>STYLE 7: PIN 1. GATE 2. COLLECTOR 3. EMITTER 4. COLLECTOR</p> | |

GENERIC MARKING DIAGRAM*



IC Discrete

- XXXXXX = Device Code
- A = Assembly Location
- L = Wafer Lot
- Y = Year
- WW = Work Week
- G = Pb-Free Package

*This information is generic. Please refer to device data sheet for actual part marking.

SOLDERING FOOTPRINT*



SCALE 3:1 (mm/inches)

*For additional information on our Pb-Free strategy and soldering details, please download the ON Semiconductor Soldering and Mounting Techniques Reference Manual, SOLDETRM/D.

| | | |
|------------------|---------------------|--|
| DOCUMENT NUMBER: | 98AON13126D | Electronic versions are uncontrolled except when accessed directly from the Document Repository. Printed versions are uncontrolled except when stamped "CONTROLLED COPY" in red. |
| DESCRIPTION: | DPAK (SINGLE GAUGE) | PAGE 1 OF 1 |

ON Semiconductor and ON are trademarks of Semiconductor Components Industries, LLC dba ON Semiconductor or its subsidiaries in the United States and/or other countries. ON Semiconductor reserves the right to make changes without further notice to any products herein. ON Semiconductor makes no warranty, representation or guarantee regarding the suitability of its products for any particular purpose, nor does ON Semiconductor assume any liability arising out of the application or use of any product or circuit, and specifically disclaims any and all liability, including without limitation special, consequential or incidental damages. ON Semiconductor does not convey any license under its patent rights nor the rights of others.

onsemi, **Onsemi**, and other names, marks, and brands are registered and/or common law trademarks of Semiconductor Components Industries, LLC dba "**onsemi**" or its affiliates and/or subsidiaries in the United States and/or other countries. **onsemi** owns the rights to a number of patents, trademarks, copyrights, trade secrets, and other intellectual property. A listing of **onsemi**'s product/patent coverage may be accessed at www.onsemi.com/site/pdf/Patent-Marking.pdf. **onsemi** reserves the right to make changes at any time to any products or information herein, without notice. The information herein is provided "as-is" and **onsemi** makes no warranty, representation or guarantee regarding the accuracy of the information, product features, availability, functionality, or suitability of its products for any particular purpose, nor does **onsemi** assume any liability arising out of the application or use of any product or circuit, and specifically disclaims any and all liability, including without limitation special, consequential or incidental damages. Buyer is responsible for its products and applications using **onsemi** products, including compliance with all laws, regulations and safety requirements or standards, regardless of any support or applications information provided by **onsemi**. "Typical" parameters which may be provided in **onsemi** data sheets and/or specifications can and do vary in different applications and actual performance may vary over time. All operating parameters, including "Typicals" must be validated for each customer application by customer's technical experts. **onsemi** does not convey any license under any of its intellectual property rights nor the rights of others. **onsemi** products are not designed, intended, or authorized for use as a critical component in life support systems or any FDA Class 3 medical devices or medical devices with a same or similar classification in a foreign jurisdiction or any devices intended for implantation in the human body. Should Buyer purchase or use **onsemi** products for any such unintended or unauthorized application, Buyer shall indemnify and hold **onsemi** and its officers, employees, subsidiaries, affiliates, and distributors harmless against all claims, costs, damages, and expenses, and reasonable attorney fees arising out of, directly or indirectly, any claim of personal injury or death associated with such unintended or unauthorized use, even if such claim alleges that **onsemi** was negligent regarding the design or manufacture of the part. **onsemi** is an Equal Opportunity/Affirmative Action Employer. This literature is subject to all applicable copyright laws and is not for resale in any manner.

ADDITIONAL INFORMATION

TECHNICAL PUBLICATIONS:

Technical Library: www.onsemi.com/design/resources/technical-documentation
onsemi Website: www.onsemi.com

ONLINE SUPPORT: www.onsemi.com/support

For additional information, please contact your local Sales Representative at www.onsemi.com/support/sales