

# Silicon Carbide (SiC) MOSFET – EliteSiC, 12 mohm, 650 V, M2, D2PAK-7L

## NTBG015N065SC1

### Features

- Typ.  $R_{DS(on)} = 12\text{ m}\Omega @ V_{GS} = 18\text{ V}$   
Typ.  $R_{DS(on)} = 15\text{ m}\Omega @ V_{GS} = 15\text{ V}$
- Ultra Low Gate Charge ( $Q_{G(tot)} = 283\text{ nC}$ )
- Low Effective Output Capacitance ( $C_{oss} = 424\text{ pF}$ )
- 100% Avalanche Tested
- $T_J = 175^\circ\text{C}$
- This Device is Halide Free and RoHS Compliant with exemption 7a, Pb-Free 2LI (on second level interconnection)

### Typical Applications

- SMPS (Switching Mode Power Supplies)
- Solar Inverters
- UPS (Uninterruptable Power Supplies)
- Energy Storages

### MAXIMUM RATINGS ( $T_J = 25^\circ\text{C}$ unless otherwise noted)

Parameter		Symbol	Value	Unit	
Drain-to-Source Voltage		$V_{DSS}$	650	V	
Gate-to-Source Voltage		$V_{GS}$	-8/+22	V	
Recommended Operation Values of Gate - Source Voltage		$T_C < 175^\circ\text{C}$ $V_{GSop}$	-5/+18	V	
Continuous Drain Current $R_{\theta JC}$ (Note 2)	Steady State	$T_C = 25^\circ\text{C}$	$I_D$	145	A
			$P_D$	500	W
Power Dissipation $R_{\theta JA}$ (Notes 1, 2)	Steady State	$T_C = 100^\circ\text{C}$	$I_D$	103	A
			$P_D$	250	W
Pulsed Drain Current (Note 3)		$T_C = 25^\circ\text{C}$	$I_{DM}$	422	A
Operating Junction and Storage Temperature Range		$T_J, T_{stg}$	-55 to +175	$^\circ\text{C}$	
Source Current (Body Diode)		$I_S$	111	A	
Single Pulse Drain-to-Source Avalanche Energy ( $I_L = 13\text{ A}_{pk}$ , $L = 1\text{ mH}$ ) (Note 4)		$E_{AS}$	84	mJ	
Maximum Lead Temperature for Soldering, 1/8" from Case for 10 Seconds		$T_L$	245	$^\circ\text{C}$	

Stresses exceeding those listed in the Maximum Ratings table may damage the device. If any of these limits are exceeded, device functionality should not be assumed, damage may occur and reliability may be affected.

1. Surface mounted on a FR-4 board using 1 in<sup>2</sup> pad of 2 oz copper.
2. The entire application environment impacts the thermal resistance values shown, they are not constants and are only valid for the particular conditions noted.
3. Repetitive rating, limited by max junction temperature.
4.  $E_{AS}$  of 84 mJ is based on starting  $T_J = 25^\circ\text{C}$ ;  $L = 1\text{ mH}$ ,  $I_{AS} = 13\text{ A}$ ,  $V_{DD} = 50\text{ V}$ ,  $V_{GS} = 18\text{ V}$ .

$V_{(BR)DSS}$	$R_{DS(on)}\text{ MAX}$	$I_D\text{ MAX}$
650 V	18 m $\Omega$ @ 18 V	145 A

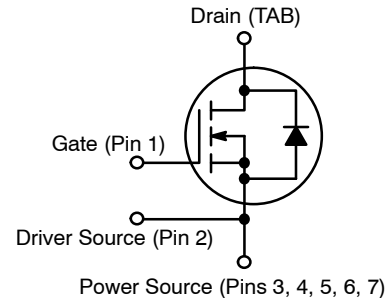

N-CHANNEL MOSFET

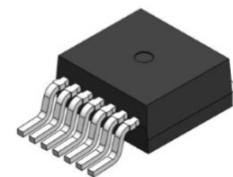

D2PAK-7L  
CASE 418BJ

### MARKING DIAGRAM

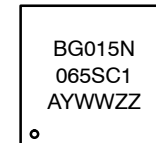

BG015N065SC1 = Specific Device Code  
A = Assembly Location  
Y = Year  
WW = Work Week  
ZZ = Lot Traceability

### ORDERING INFORMATION

Device	Package	Shipping†
NTBG015N065SC1	D2PAK-7L	800 / Tape & Reel

†For information on tape and reel specifications, including part orientation and tape sizes, please refer to our Tape and Reel Packaging Specifications Brochure, [BRD8011/D](#).

# NTBG015N065SC1

## THERMAL CHARACTERISTICS

Parameter	Symbol	Max	Unit
Thermal Resistance Junction-to-Case (Note 2)	$R_{\theta JC}$	0.3	$^{\circ}C/W$
Thermal Resistance Junction-to-Ambient (Notes 1, 2)	$R_{\theta JA}$	40	$^{\circ}C/W$

## ELECTRICAL CHARACTERISTICS ( $T_J = 25^{\circ}C$ unless otherwise stated)

Parameter	Symbol	Test Condition	Min	Typ	Max	Unit
<b>OFF CHARACTERISTICS</b>						
Drain-to-Source Breakdown Voltage	$V_{(BR)DSS}$	$V_{GS} = 0 V, I_D = 1 mA$	650			V
Drain-to-Source Breakdown Voltage Temperature Coefficient	$V_{(BR)DSS}/T_J$	$I_D = 20 mA$ , refer to $25^{\circ}C$		0.12		$V/^{\circ}C$
Zero Gate Voltage Drain Current	$I_{DSS}$	$V_{GS} = 0 V,$ $V_{DS} = 650 V$	$T_J = 25^{\circ}C$		10	$\mu A$
			$T_J = 175^{\circ}C$		1	mA
Gate-to-Source Leakage Current	$I_{GSS}$	$V_{GS} = +22/-8 V, V_{DS} = 0 V$			250	nA

## ON CHARACTERISTICS

Gate Threshold Voltage	$V_{GS(TH)}$	$V_{GS} = V_{DS}, I_D = 25 mA$	1.8	2.8	4.3	V
Recommended Gate Voltage	$V_{GOP}$		-5		+18	V
Drain-to-Source On Resistance	$R_{DS(on)}$	$V_{GS} = 15 V, I_D = 75 A, T_J = 25^{\circ}C$		15		m $\Omega$
		$V_{GS} = 18 V, I_D = 75 A, T_J = 25^{\circ}C$		12	18	
		$V_{GS} = 18 V, I_D = 75 A, T_J = 175^{\circ}C$		16		
Forward Transconductance	$g_{FS}$	$V_{DS} = 10 V, I_D = 75 A$		42		S

## CHARGES, CAPACITANCES & GATE RESISTANCE

Input Capacitance	$C_{ISS}$	$V_{GS} = 0 V, f = 1 MHz,$ $V_{DS} = 325 V$		4689		pF
Output Capacitance	$C_{OSS}$			424		
Reverse Transfer Capacitance	$C_{RSS}$			37		
Total Gate Charge	$Q_{G(TOT)}$	$V_{GS} = -5/18 V, V_{DS} = 520 V,$ $I_D = 75 A$		283		nC
Gate-to-Source Charge	$Q_{GS}$			72		
Gate-to-Drain Charge	$Q_{GD}$			64		
Gate-Resistance	$R_G$	$f = 1 MHz$		1.6		$\Omega$

## SWITCHING CHARACTERISTICS

Turn-On Delay Time	$t_{d(ON)}$	$V_{GS} = -5/18 V, V_{DS} = 400 V,$ $I_D = 75 A, R_G = 2.2 \Omega,$ Inductive Load		23		ns
Rise Time	$t_r$			26		
Turn-Off Delay Time	$t_{d(OFF)}$			49		
Fall Time	$t_f$			9.6		
Turn-On Switching Loss	$E_{ON}$			167		$\mu J$
Turn-Off Switching Loss	$E_{OFF}$			276		
Total Switching Loss	$E_{TOT}$			443		

## DRAIN-SOURCE DIODE CHARACTERISTICS

Continuous Drain-Source Diode Forward Current	$I_{SD}$	$V_{GS} = -5 V, T_J = 25^{\circ}C$			111	A
Pulsed Drain-Source Diode Forward Current (Note 3)	$I_{SDM}$	$V_{GS} = -5 V, T_J = 25^{\circ}C$			422	A
Forward Diode Voltage	$V_{SD}$	$V_{GS} = -5 V, I_{SD} = 75 A, T_J = 25^{\circ}C$		4.8		V

# NTBG015N065SC1

## ELECTRICAL CHARACTERISTICS ( $T_J = 25^\circ\text{C}$ unless otherwise stated)(continued)

Parameter	Symbol	Test Condition	Min	Typ	Max	Unit
<b>DRAIN-SOURCE DIODE CHARACTERISTICS</b>						
Reverse Recovery Time	$t_{RR}$	$V_{GS} = -5/18 \text{ V}, I_{SD} = 75 \text{ A},$ $dI_S/dt = 1000 \text{ A}/\mu\text{s}$		28		ns
Reverse Recovery Charge	$Q_{RR}$			234		nC
Reverse Recovery Energy	$E_{REC}$			23		$\mu\text{J}$
Peak Reverse Recovery Current	$I_{RRM}$			16		A
Charge Time	$T_a$			17		ns
Discharge Time	$T_b$			11		ns

Product parametric performance is indicated in the Electrical Characteristics for the listed test conditions, unless otherwise noted. Product performance may not be indicated by the Electrical Characteristics if operated under different conditions.

# NTBG015N065SC1

## TYPICAL CHARACTERISTICS

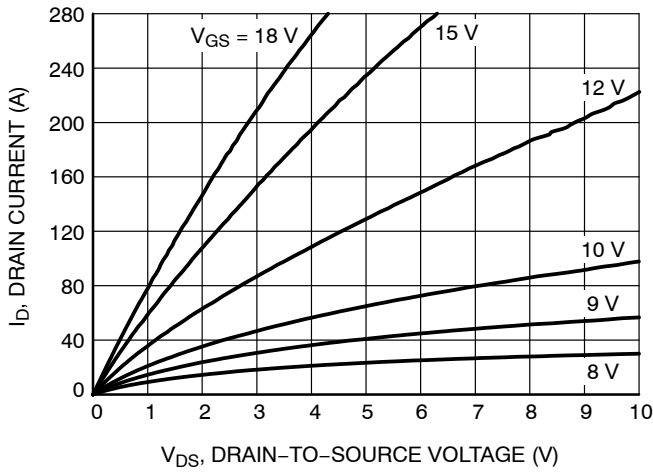

Figure 1. On-Region Characteristics

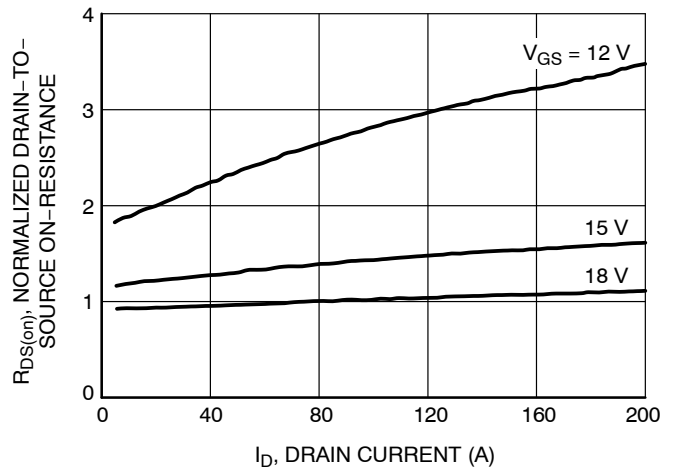

Figure 2. Normalized On-Resistance vs. Drain Current and Gate Voltage

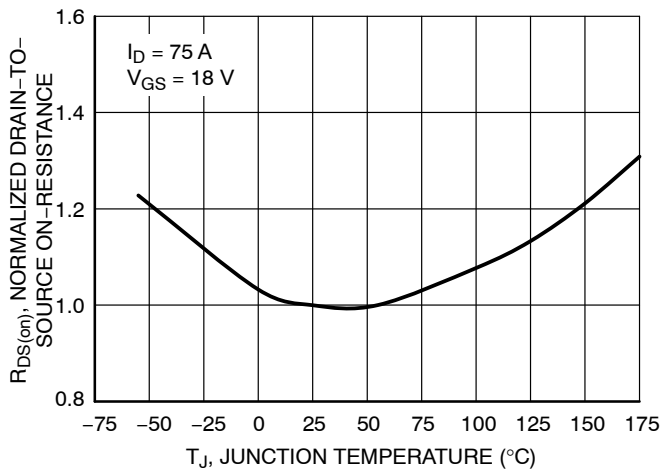

Figure 3. On-Resistance Variation with Temperature

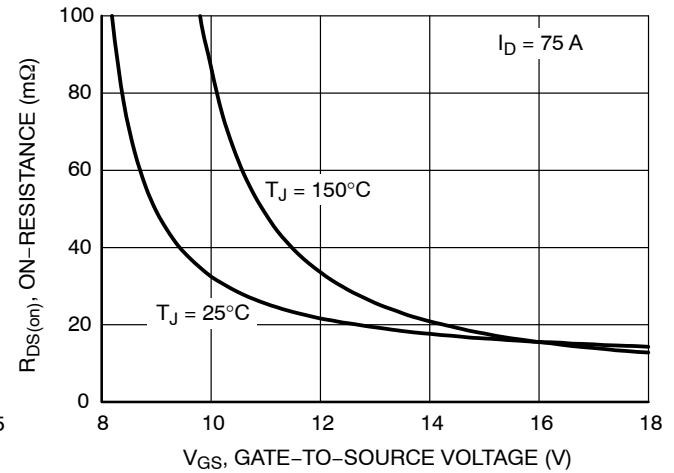

Figure 4. On-Resistance vs. Gate-to-Source Voltage

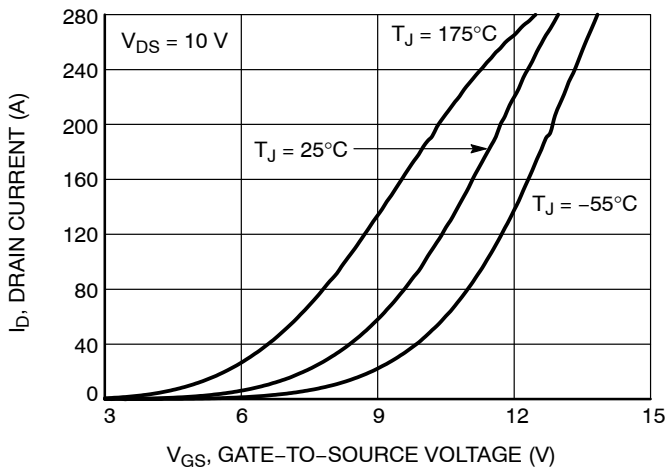

Figure 5. Transfer Characteristics

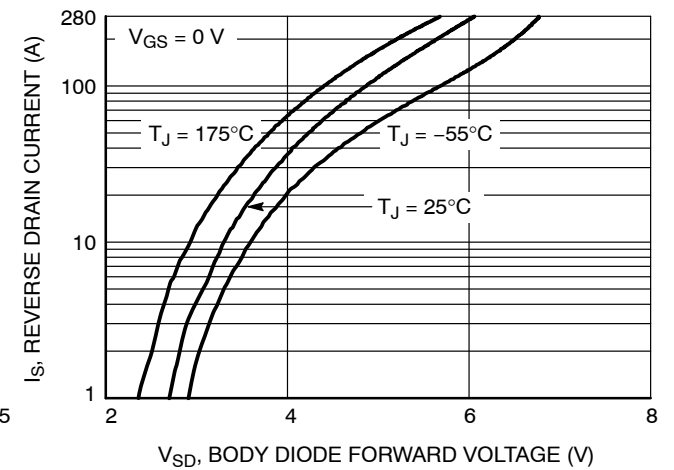
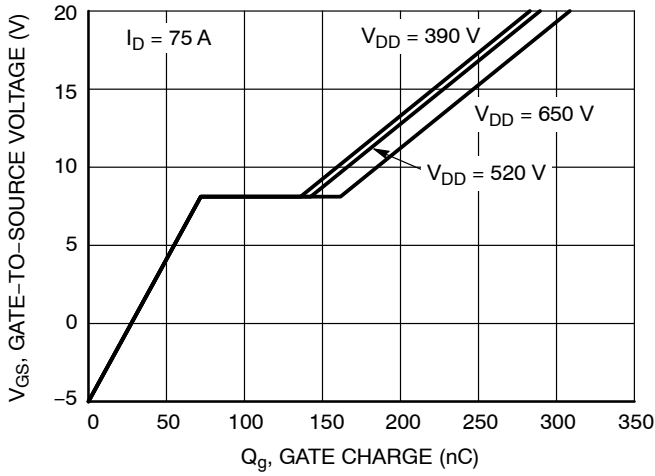

Figure 6. Diode Forward Voltage vs. Current

# NTBG015N065SC1

## TYPICAL CHARACTERISTICS (continued)



**Figure 7. Gate-to-Source Voltage vs. Total Charge**

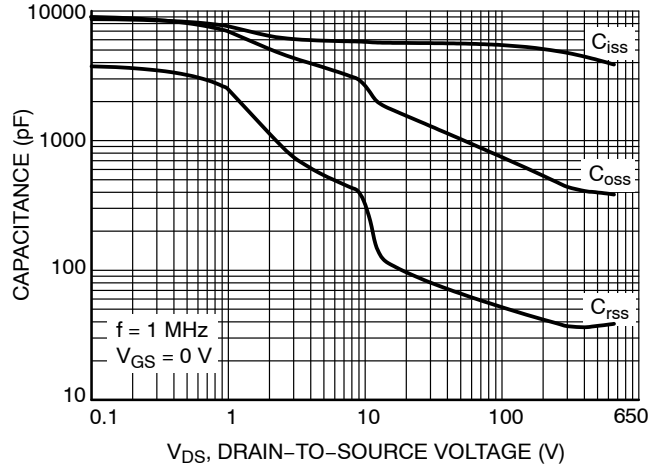

**Figure 8. Capacitance vs. Drain-to-Source Voltage**

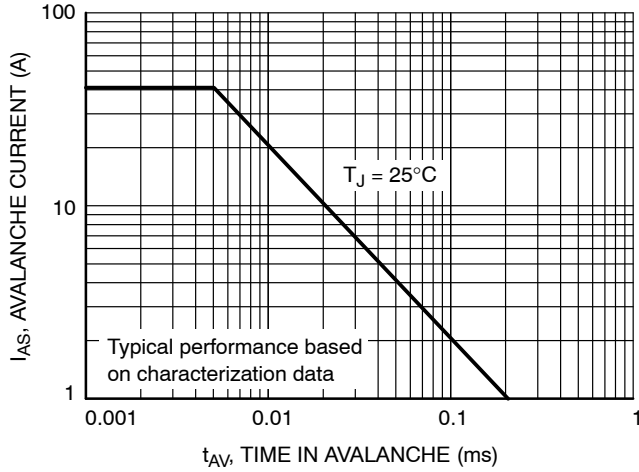

**Figure 9. Unclamped Inductive Switching Capability**

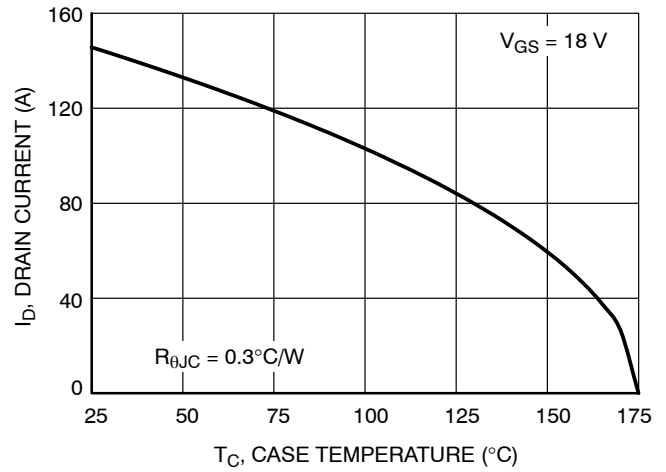

**Figure 10. Maximum Continuous Drain Current vs. Case Temperature**

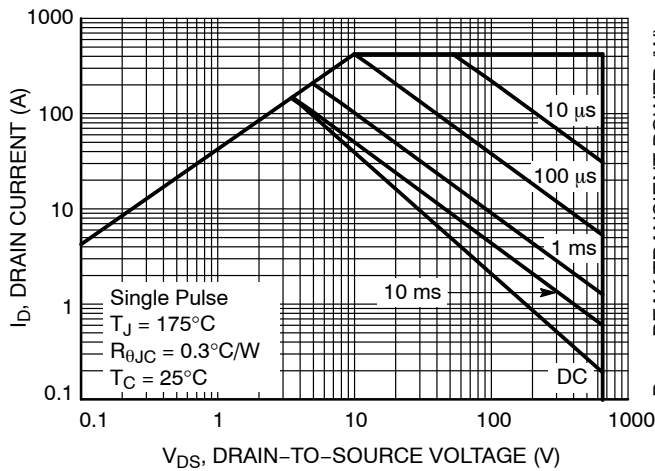

**Figure 11. Safe Operating Area**

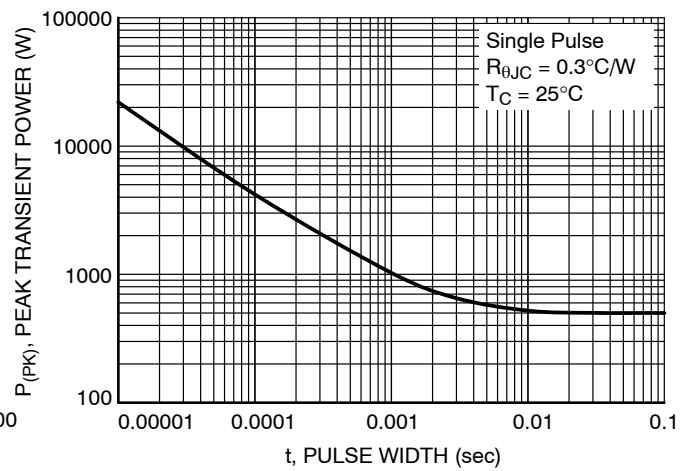

**Figure 12. Single Pulse Maximum Power Dissipation**

# NTBG015N065SC1

## TYPICAL CHARACTERISTICS (continued)

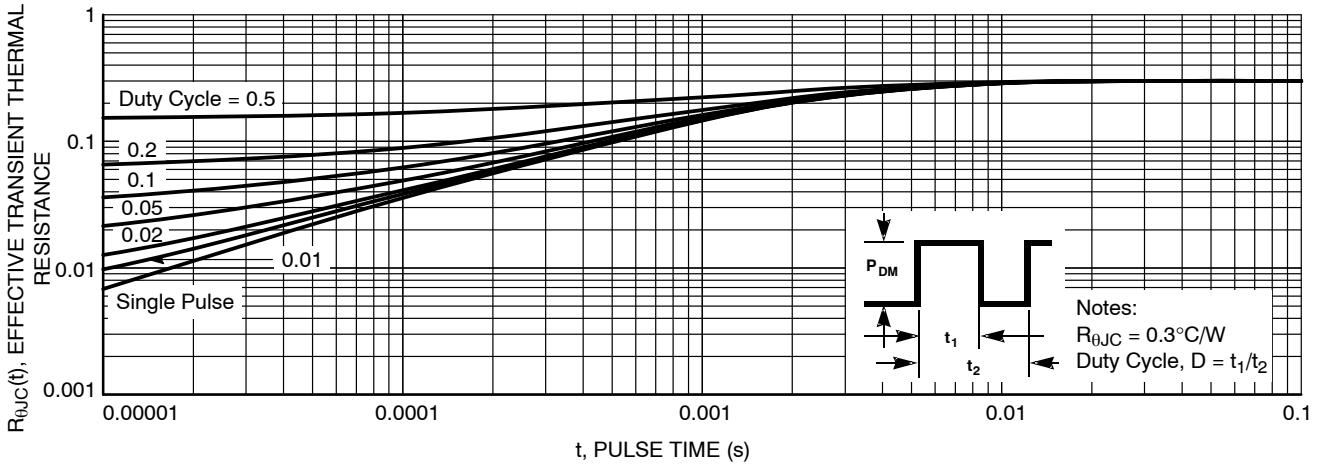
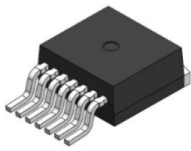

Figure 13. Junction-to-Case Transient Thermal Response Curve

# MECHANICAL CASE OUTLINE PACKAGE DIMENSIONS



## D<sup>2</sup>PAK7 (TO-263-7L HV) CASE 418BJ ISSUE B

DATE 16 AUG 2019

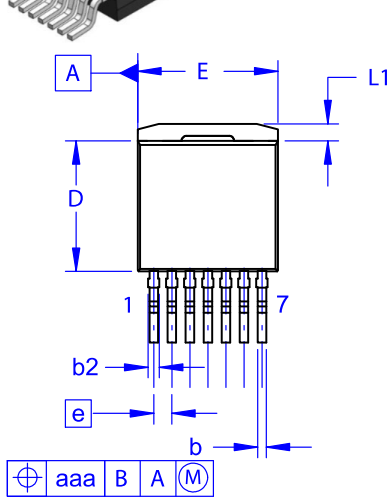

NOTES:

- A. PACKAGE CONFORMS TO JEDEC TO-263 VARIATION CB EXCEPT WHERE NOTED.
- B. ALL DIMENSIONS ARE IN MILLIMETERS.
- C. OUT OF JEDEC STANDARD VALUE.
- D. DIMENSION AND TOLERANCE AS PER ASME Y14.5-2009.
- E. DIMENSIONS ARE EXCLUSIVE OF BURRS, MOLD FLASH AND TIE BAR PROTRUSIONS.

DIM	MILLIMETERS		
	MIN	NOM	MAX
A	4.30	4.50	4.70
A1	0.00	0.10	0.20
b2	0.60	0.70	0.80
b	0.51	0.60	0.70
c	0.40	0.50	0.60
c2	1.20	1.30	1.40
D	9.00	9.20	9.40
D1	6.15	6.80	7.15
E	9.70	9.90	10.20
E1	7.15	7.65	8.15
e	~	1.27	~
H	15.10	15.40	15.70
L	2.44	2.64	2.84
L1	1.00	1.20	1.40
L3	~	0.25	~
aaa	~	~	0.25

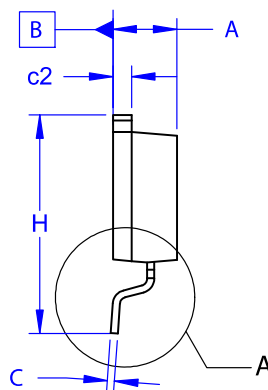

### GENERIC MARKING DIAGRAM\*



- XXXX = Specific Device Code
- A = Assembly Location
- Y = Year
- WW = Work Week
- G = Pb-Free Package

\*This information is generic. Please refer to device data sheet for actual part marking. Pb-Free indicator, "G" or microdot "•", may or may not be present. Some products may not follow the Generic Marking.



<b>DOCUMENT NUMBER:</b>	<b>98AON84234G</b>	Electronic versions are uncontrolled except when accessed directly from the Document Repository. Printed versions are uncontrolled except when stamped "CONTROLLED COPY" in red.
<b>DESCRIPTION:</b>	<b>D<sup>2</sup>PAK7 (TO-263-7L HV)</b>	<b>PAGE 1 OF 1</b>

onsemi and ONSEMI are trademarks of Semiconductor Components Industries, LLC dba onsemi or its subsidiaries in the United States and/or other countries. onsemi reserves the right to make changes without further notice to any products herein. onsemi makes no warranty, representation or guarantee regarding the suitability of its products for any particular purpose, nor does onsemi assume any liability arising out of the application or use of any product or circuit, and specifically disclaims any and all liability, including without limitation special, consequential or incidental damages. onsemi does not convey any license under its patent rights nor the rights of others.

**onsemi**, **Onsemi**, and other names, marks, and brands are registered and/or common law trademarks of Semiconductor Components Industries, LLC dba "**onsemi**" or its affiliates and/or subsidiaries in the United States and/or other countries. **onsemi** owns the rights to a number of patents, trademarks, copyrights, trade secrets, and other intellectual property. A listing of **onsemi**'s product/patent coverage may be accessed at [www.onsemi.com/site/pdf/Patent-Marking.pdf](http://www.onsemi.com/site/pdf/Patent-Marking.pdf). **onsemi** reserves the right to make changes at any time to any products or information herein, without notice. The information herein is provided "as-is" and **onsemi** makes no warranty, representation or guarantee regarding the accuracy of the information, product features, availability, functionality, or suitability of its products for any particular purpose, nor does **onsemi** assume any liability arising out of the application or use of any product or circuit, and specifically disclaims any and all liability, including without limitation special, consequential or incidental damages. Buyer is responsible for its products and applications using **onsemi** products, including compliance with all laws, regulations and safety requirements or standards, regardless of any support or applications information provided by **onsemi**. "Typical" parameters which may be provided in **onsemi** data sheets and/or specifications can and do vary in different applications and actual performance may vary over time. All operating parameters, including "Typicals" must be validated for each customer application by customer's technical experts. **onsemi** does not convey any license under any of its intellectual property rights nor the rights of others. **onsemi** products are not designed, intended, or authorized for use as a critical component in life support systems or any FDA Class 3 medical devices or medical devices with a same or similar classification in a foreign jurisdiction or any devices intended for implantation in the human body. Should Buyer purchase or use **onsemi** products for any such unintended or unauthorized application, Buyer shall indemnify and hold **onsemi** and its officers, employees, subsidiaries, affiliates, and distributors harmless against all claims, costs, damages, and expenses, and reasonable attorney fees arising out of, directly or indirectly, any claim of personal injury or death associated with such unintended or unauthorized use, even if such claim alleges that **onsemi** was negligent regarding the design or manufacture of the part. **onsemi** is an Equal Opportunity/Affirmative Action Employer. This literature is subject to all applicable copyright laws and is not for resale in any manner.

---

## ADDITIONAL INFORMATION

### TECHNICAL PUBLICATIONS:

Technical Library: [www.onsemi.com/design/resources/technical-documentation](http://www.onsemi.com/design/resources/technical-documentation)  
onsemi Website: [www.onsemi.com](http://www.onsemi.com)

### ONLINE SUPPORT: [www.onsemi.com/support](http://www.onsemi.com/support)

For additional information, please contact your local Sales Representative at [www.onsemi.com/support/sales](http://www.onsemi.com/support/sales)