

# NTA4151P, NTE4151P

## MOSFET – Single, P-Channel, Small Signal, Gate Zener, SC-75, SC-89

**-20 V, -760 mA**

### Features

- Low  $R_{DS(on)}$  for Higher Efficiency and Longer Battery Life
- Small Outline Package (1.6 x 1.6 mm)
- SC-75 Standard Gullwing Package
- ESD Protected Gate
- These Devices are Pb-Free, Halogen Free/BFR Free and are RoHS Compliant

### Applications

- High Side Load Switch
- DC-DC Conversion
- Small Drive Circuits
- Battery Operated Systems such as Cell Phones, PDAs, Digital Cameras, etc.

### MAXIMUM RATINGS ( $T_J = 25^\circ\text{C}$ unless otherwise stated)

Parameter		Symbol	Value	Units
Drain-to-Source Voltage		$V_{DSS}$	-20	V
Gate-to-Source Voltage		$V_{GS}$	$\pm 6.0$	V
Continuous Drain Current (Note 1)	Steady State	$I_D$	-760	mA
Power Dissipation (Note 1)	Steady State	$P_D$	301	mW
SC-75			313	
Pulsed Drain Current	$t_p = 10 \mu\text{s}$	$I_{DM}$	$\pm 1000$	mA
Operating Junction and Storage Temperature		$T_J, T_{STG}$	-55 to 150	$^\circ\text{C}$
Continuous Source Current (Body Diode)		$I_S$	-250	mA
Lead Temperature for Soldering Purposes (1/8 in from case for 10 s)		$T_L$	260	$^\circ\text{C}$
Gate-to-Source ESD Rating – (Human Body Model, Method 3015)		ESD	1800	V

### THERMAL RESISTANCE RATINGS

Junction-to-Ambient – Steady State (Note 1)	$R_{\theta JA}$	Value	$^\circ\text{C}/\text{W}$
SC-75		415	
SC-89		400	

Stresses exceeding those listed in the Maximum Ratings table may damage the device. If any of these limits are exceeded, device functionality should not be assumed, damage may occur and reliability may be affected.

1. Surface mounted on FR4 board using 1 in sq pad size (Cu area = 1.127 in sq [1 oz] including traces).



ON Semiconductor®

[www.onsemi.com](http://www.onsemi.com)

$V_{(BR)DSS}$	$R_{DS(on)}$ TYP	$I_D$ MAX
-20 V	0.26 $\Omega$ @ -4.5 V	-760 mA
	0.35 $\Omega$ @ -2.5 V	
	0.49 $\Omega$ @ -1.8 V	

### P-Channel MOSFET

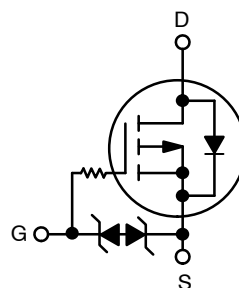

### MARKING DIAGRAM & PIN ASSIGNMENT

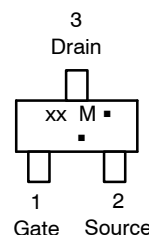
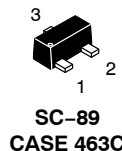
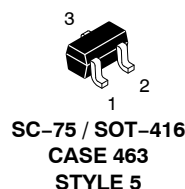

xx = Device Code  
M = Date Code\*  
■ = Pb-Free Package

(Note: Microdot may be in either location)

\*Date Code orientation may vary depending upon manufacturing location.

### ORDERING INFORMATION

See detailed ordering and shipping information in the package dimensions section on page 2 of this data sheet.

# NTA4151P, NTE4151P

## ELECTRICAL CHARACTERISTICS (T<sub>J</sub> = 25°C unless otherwise stated)

Parameter	Symbol	Test Condition	Min	Typ	Max	Unit
-----------	--------	----------------	-----	-----	-----	------

### OFF CHARACTERISTICS

Drain-to-Source Breakdown Voltage	V <sub>(BR)DSS</sub>	V <sub>GS</sub> = 0 V, I <sub>D</sub> = -250 μA	-20			V
Zero Gate Voltage Drain Current	I <sub>DSS</sub>	V <sub>GS</sub> = 0 V, V <sub>DS</sub> = -16 V		-1.0	-100	nA
Gate-to-Source Leakage Current	I <sub>GSS</sub>	V <sub>DS</sub> = 0 V, V <sub>GS</sub> = ±4.5 V		±1.0	±10	μA

### ON CHARACTERISTICS (Note 2)

Gate Threshold Voltage	V <sub>GS(TH)</sub>	V <sub>DS</sub> = V <sub>GS</sub> , I <sub>D</sub> = -250 μA	-0.45		-1.2	V
Drain-to-Source On Resistance	R <sub>DS(on)</sub>	V <sub>GS</sub> = -4.5 V, I <sub>D</sub> = -350 mA		0.26	0.36	Ω
		V <sub>GS</sub> = -2.5 V, I <sub>D</sub> = -300 mA		0.35	0.45	
		V <sub>GS</sub> = -1.8 V, I <sub>D</sub> = -150 mA		0.49	1.0	
Forward Transconductance	g <sub>FS</sub>	V <sub>DS</sub> = -10 V, I <sub>D</sub> = -250 mA		0.4		S

### CHARGES AND CAPACITANCES

Input Capacitance	C <sub>ISS</sub>	V <sub>GS</sub> = 0 V, f = 1.0 MHz, V <sub>DS</sub> = -5.0 V		156		pF
Output Capacitance	C <sub>OSS</sub>			28		
Reverse Transfer Capacitance	C <sub>RSS</sub>			18		
Total Gate Charge	Q <sub>G(TOT)</sub>	V <sub>GS</sub> = -4.5 V, V <sub>DD</sub> = -10 V, I <sub>D</sub> = -0.3 A		2.1		nC
Threshold Gate Charge	Q <sub>G(TH)</sub>			0.125		
Gate-to-Source Charge	Q <sub>GS</sub>			0.325		
Gate-to-Drain Charge	Q <sub>GD</sub>			0.5		

### SWITCHING CHARACTERISTICS (Note 3)

Turn-On Delay Time	t <sub>d(ON)</sub>	V <sub>GS</sub> = -4.5 V, V <sub>DD</sub> = -10 V, I <sub>D</sub> = -200 mA, R <sub>G</sub> = 10 Ω		8.0		ns
Rise Time	t <sub>r</sub>			8.2		
Turn-Off Delay Time	t <sub>d(OFF)</sub>			29		
Fall Time	t <sub>f</sub>			20.4		

### DRAIN-SOURCE DIODE CHARACTERISTICS

Forward Diode Voltage	V <sub>SD</sub>	V <sub>GS</sub> = 0 V, I <sub>S</sub> = -250 mA		-0.72	-1.1	V
-----------------------	-----------------	---	--	-------	------	---

Product parametric performance is indicated in the Electrical Characteristics for the listed test conditions, unless otherwise noted. Product performance may not be indicated by the Electrical Characteristics if operated under different conditions.

2. Pulse Test: pulse width ≤ 300 μs, duty cycle ≤ 2%.

3. Switching characteristics are independent of operating junction temperatures.

### ORDERING INFORMATION

Device	Marking	Package	Shipping <sup>†</sup>
NTA4151PT1G	TN	SC-75 (Pb-Free)	3000 / Tape & Reel
NTE4151PT1G	TM	SC-89 (Pb-Free)	3000 / Tape & Reel

<sup>†</sup>For information on tape and reel specifications, including part orientation and tape sizes, please refer to our Tape and Reel Packaging Specifications Brochure, BRD8011/D.

# NTA4151P, NTE4151P

## TYPICAL ELECTRICAL CHARACTERISTICS

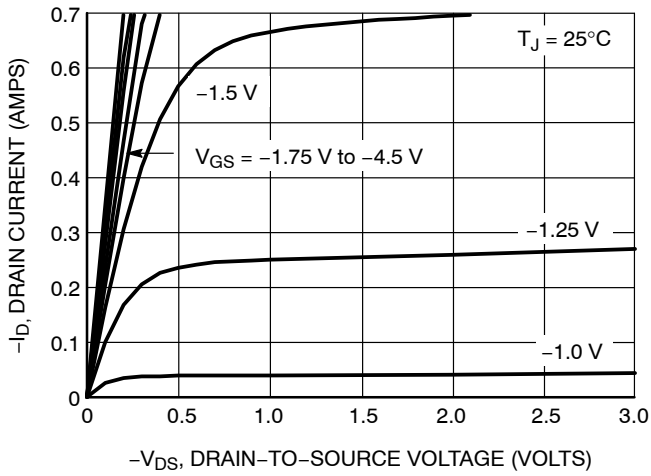

Figure 1. On-Region Characteristics

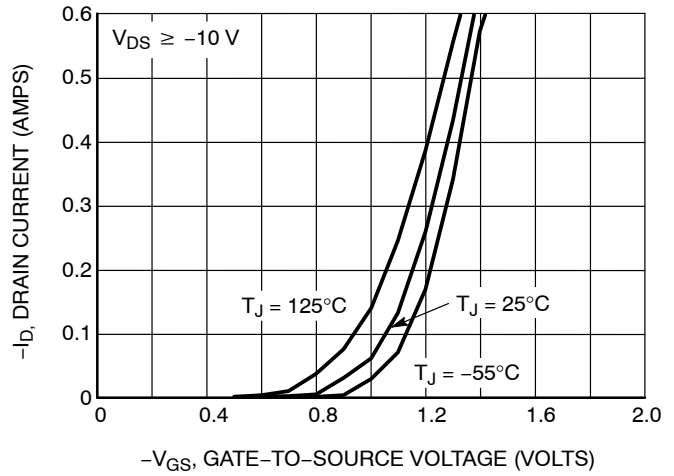

Figure 2. Transfer Characteristics

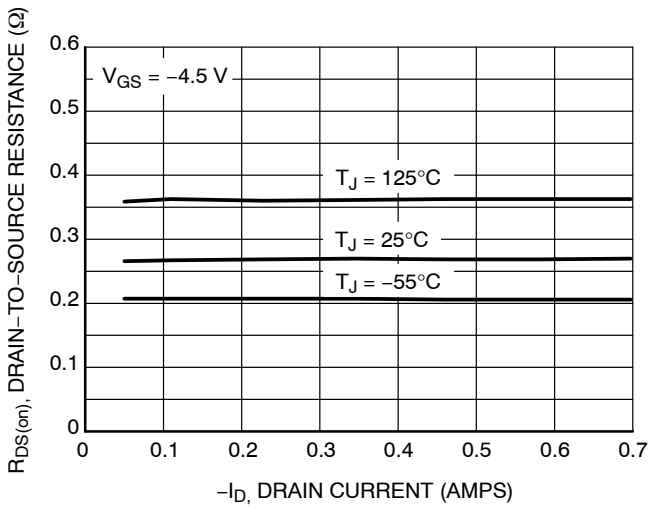

Figure 3. On-Resistance vs. Drain Current and Temperature

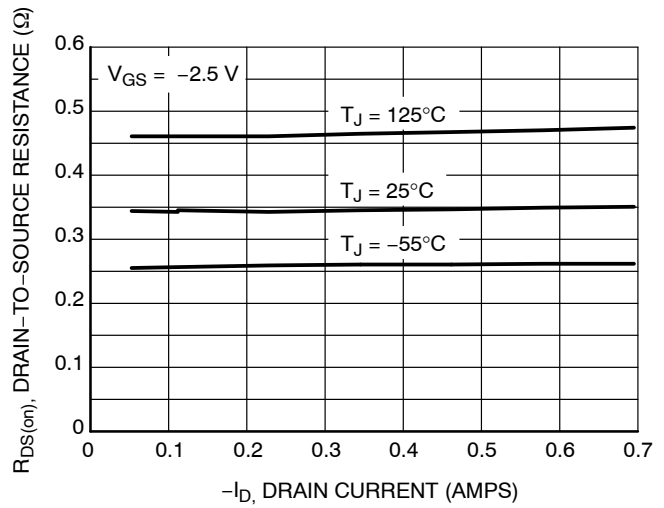

Figure 4. On-Resistance vs. Drain Current and Temperature

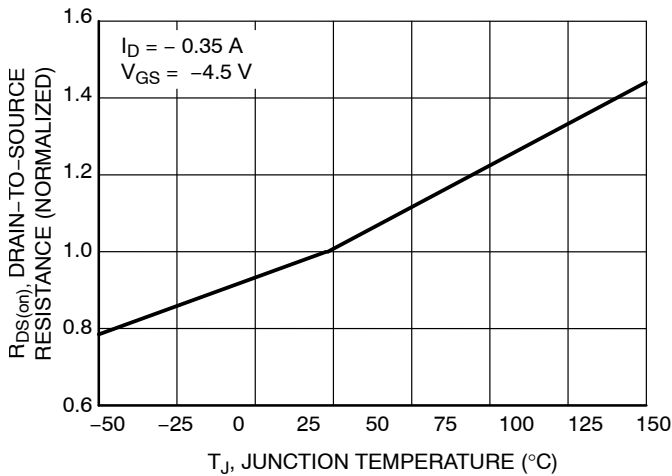

Figure 5. On-Resistance Variation with Temperature

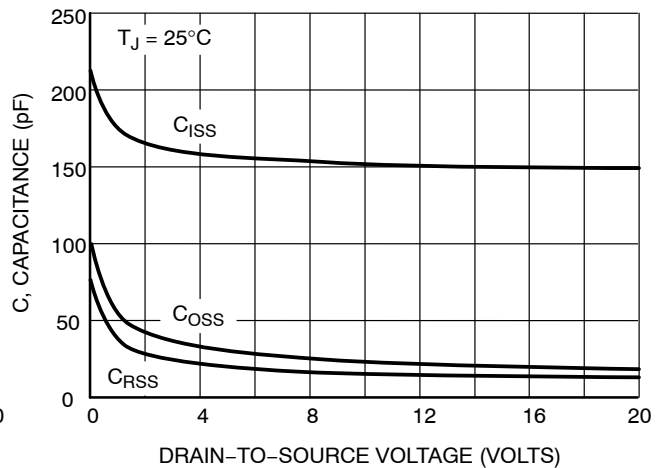
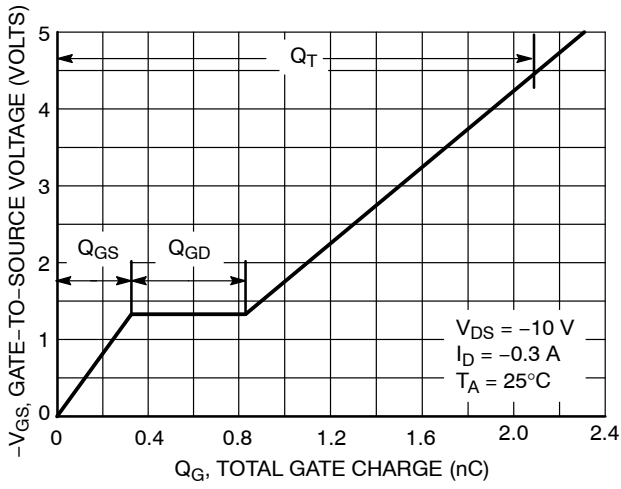

Figure 6. Capacitance Variation

# NTA4151P, NTE4151P

## TYPICAL ELECTRICAL CHARACTERISTICS



**Figure 7. Gate-to-Source Voltage vs. Total Gate Charge**

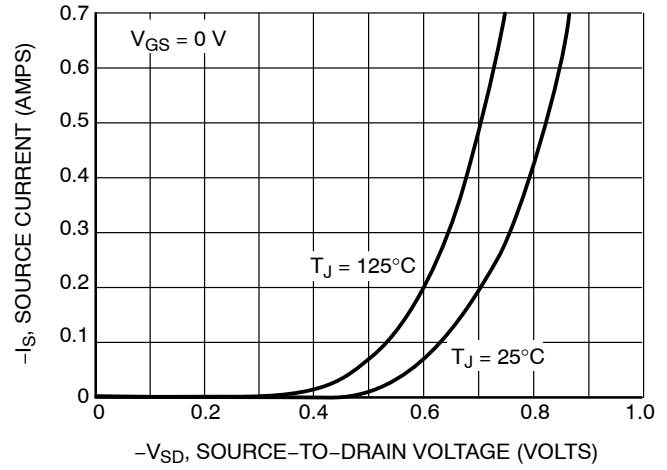

**Figure 8. Diode Forward Voltage vs. Current**

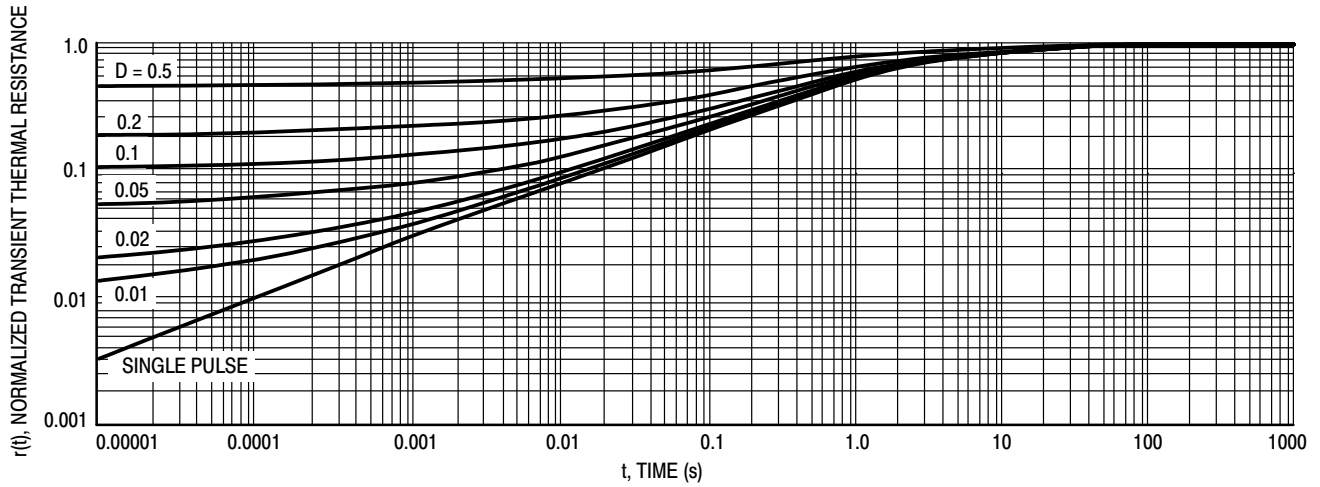

**Figure 9. Normalized Thermal Response**

# MECHANICAL CASE OUTLINE

## PACKAGE DIMENSIONS

ON Semiconductor®



**SC-75/SOT-416**  
CASE 463-01  
ISSUE G

DATE 07 AUG 2015

SCALE 4:1

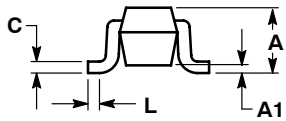

STYLE 1:  
PIN 1. BASE  
2. EMITTER  
3. COLLECTOR

STYLE 2:  
PIN 1. ANODE  
2. N/C  
3. CATHODE

STYLE 3:  
PIN 1. ANODE  
2. ANODE  
3. CATHODE

STYLE 4:  
PIN 1. CATHODE  
2. CATHODE  
3. ANODE

STYLE 5:  
PIN 1. GATE  
2. SOURCE  
3. DRAIN

NOTES:

1. DIMENSIONING AND TOLERANCING PER ANSI Y14.5M, 1982.
2. CONTROLLING DIMENSION: MILLIMETER.

DIM	MILLIMETERS			INCHES		
	MIN	NOM	MAX	MIN	NOM	MAX
A	0.70	0.80	0.90	0.027	0.031	0.035
A1	0.00	0.05	0.10	0.000	0.002	0.004
b	0.15	0.20	0.30	0.006	0.008	0.012
C	0.10	0.15	0.25	0.004	0.006	0.010
D	1.55	1.60	1.65	0.061	0.063	0.065
E	0.70	0.80	0.90	0.027	0.031	0.035
e	1.00 BSC			0.04 BSC		
L	0.10	0.15	0.20	0.004	0.006	0.008
HE	1.50	1.60	1.70	0.060	0.063	0.067

**GENERIC MARKING DIAGRAM\***



- XX = Specific Device Code
- M = Date Code
- = Pb-Free Package

\*This information is generic. Please refer to device data sheet for actual part marking. Pb-Free indicator, "G" or microdot "■", may or may not be present.

**SOLDERING FOOTPRINT\***



SCALE 10:1 (mm/inches)

\*For additional information on our Pb-Free strategy and soldering details, please download the ON Semiconductor Soldering and Mounting Techniques Reference Manual, SOLDERRM/D.

<b>DOCUMENT NUMBER:</b>	<b>98ASB15184C</b>	Electronic versions are uncontrolled except when accessed directly from the Document Repository. Printed versions are uncontrolled except when stamped "CONTROLLED COPY" in red.
<b>DESCRIPTION:</b>	<b>SC-75/SOT-416</b>	<b>PAGE 1 OF 1</b>

ON Semiconductor and are trademarks of Semiconductor Components Industries, LLC dba ON Semiconductor or its subsidiaries in the United States and/or other countries. ON Semiconductor reserves the right to make changes without further notice to any products herein. ON Semiconductor makes no warranty, representation or guarantee regarding the suitability of its products for any particular purpose, nor does ON Semiconductor assume any liability arising out of the application or use of any product or circuit, and specifically disclaims any and all liability, including without limitation special, consequential or incidental damages. ON Semiconductor does not convey any license under its patent rights nor the rights of others.

# MECHANICAL CASE OUTLINE

## PACKAGE DIMENSIONS

ON Semiconductor®



### SC-89, 3 LEAD CASE 463C-03 ISSUE C

DATE 31 JUL 2003



SCALE 4:1

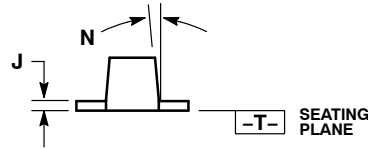
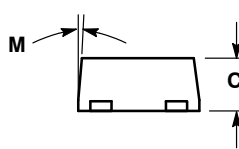
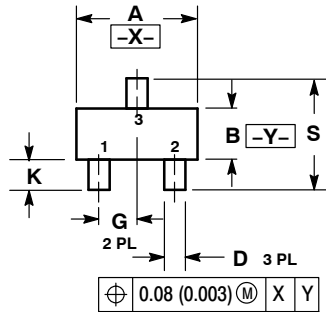

STYLE 1:  
PIN 1. BASE  
2. EMITTER  
3. COLLECTOR

STYLE 2:  
PIN 1. ANODE  
2. N/C  
3. CATHODE

STYLE 3:  
PIN 1. ANODE  
2. ANODE  
3. CATHODE

STYLE 4:  
PIN 1. CATHODE  
2. CATHODE  
3. ANODE

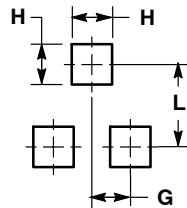

RECOMMENDED PATTERN OF SOLDER PADS

NOTES:

- DIMENSIONING AND TOLERANCING PER ANSI Y14.5M, 1982.
- CONTROLLING DIMENSION: MILLIMETERS
- MAXIMUM LEAD THICKNESS INCLUDES LEAD FINISH THICKNESS. MINIMUM LEAD THICKNESS IS THE MINIMUM THICKNESS OF BASE MATERIAL.
- 463C-01 OBSOLETE, NEW STANDARD 463C-02.

DIM	MILLIMETERS			INCHES		
	MIN	NOM	MAX	MIN	NOM	MAX
A	1.50	1.60	1.70	0.059	0.063	0.067
B	0.75	0.85	0.95	0.030	0.034	0.040
C	0.60	0.70	0.80	0.024	0.028	0.031
D	0.23	0.28	0.33	0.009	0.011	0.013
G	0.50 BSC			0.020 BSC		
H	0.53 REF			0.021 REF		
J	0.10	0.15	0.20	0.004	0.006	0.008
K	0.30	0.40	0.50	0.012	0.016	0.020
L	1.10 REF			0.043 REF		
M	---	---	10	---	---	10
N	---	---	10	---	---	10
S	1.50	1.60	1.70	0.059	0.063	0.067

### GENERIC MARKING DIAGRAM\*

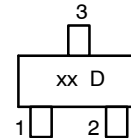

xx = Specific Device Code  
D = Date Code

\*This information is generic. Please refer to device data sheet for actual part marking.

DOCUMENT NUMBER:	98AON11472D	Electronic versions are uncontrolled except when accessed directly from the Document Repository. Printed versions are uncontrolled except when stamped "CONTROLLED COPY" in red.
DESCRIPTION:	SC-89, 3 LEAD	PAGE 1 OF 1

ON Semiconductor and are trademarks of Semiconductor Components Industries, LLC dba ON Semiconductor or its subsidiaries in the United States and/or other countries. ON Semiconductor reserves the right to make changes without further notice to any products herein. ON Semiconductor makes no warranty, representation or guarantee regarding the suitability of its products for any particular purpose, nor does ON Semiconductor assume any liability arising out of the application or use of any product or circuit, and specifically disclaims any and all liability, including without limitation special, consequential or incidental damages. ON Semiconductor does not convey any license under its patent rights nor the rights of others.

**onsemi**, **Onsemi**, and other names, marks, and brands are registered and/or common law trademarks of Semiconductor Components Industries, LLC dba "**onsemi**" or its affiliates and/or subsidiaries in the United States and/or other countries. **onsemi** owns the rights to a number of patents, trademarks, copyrights, trade secrets, and other intellectual property. A listing of **onsemi**'s product/patent coverage may be accessed at [www.onsemi.com/site/pdf/Patent-Marking.pdf](http://www.onsemi.com/site/pdf/Patent-Marking.pdf). **onsemi** reserves the right to make changes at any time to any products or information herein, without notice. The information herein is provided "as-is" and **onsemi** makes no warranty, representation or guarantee regarding the accuracy of the information, product features, availability, functionality, or suitability of its products for any particular purpose, nor does **onsemi** assume any liability arising out of the application or use of any product or circuit, and specifically disclaims any and all liability, including without limitation special, consequential or incidental damages. Buyer is responsible for its products and applications using **onsemi** products, including compliance with all laws, regulations and safety requirements or standards, regardless of any support or applications information provided by **onsemi**. "Typical" parameters which may be provided in **onsemi** data sheets and/or specifications can and do vary in different applications and actual performance may vary over time. All operating parameters, including "Typicals" must be validated for each customer application by customer's technical experts. **onsemi** does not convey any license under any of its intellectual property rights nor the rights of others. **onsemi** products are not designed, intended, or authorized for use as a critical component in life support systems or any FDA Class 3 medical devices or medical devices with a same or similar classification in a foreign jurisdiction or any devices intended for implantation in the human body. Should Buyer purchase or use **onsemi** products for any such unintended or unauthorized application, Buyer shall indemnify and hold **onsemi** and its officers, employees, subsidiaries, affiliates, and distributors harmless against all claims, costs, damages, and expenses, and reasonable attorney fees arising out of, directly or indirectly, any claim of personal injury or death associated with such unintended or unauthorized use, even if such claim alleges that **onsemi** was negligent regarding the design or manufacture of the part. **onsemi** is an Equal Opportunity/Affirmative Action Employer. This literature is subject to all applicable copyright laws and is not for resale in any manner.

## ADDITIONAL INFORMATION

### TECHNICAL PUBLICATIONS:

Technical Library: [www.onsemi.com/design/resources/technical-documentation](http://www.onsemi.com/design/resources/technical-documentation)  
onsemi Website: [www.onsemi.com](http://www.onsemi.com)

### ONLINE SUPPORT: [www.onsemi.com/support](http://www.onsemi.com/support)

For additional information, please contact your local Sales Representative at [www.onsemi.com/support/sales](http://www.onsemi.com/support/sales)

