

# Low $V_{CE(sat)}$ PNP Transistor 60 V, 2 A

## NSS60200SMT

onsemi's e<sup>2</sup>PowerEdge family of low  $V_{CE(sat)}$  transistors are miniature surface mount devices featuring ultra low saturation voltage ( $V_{CE(sat)}$ ) and high current gain capability. These are designed for use in low voltage, high speed switching applications where affordable efficient energy control is important.

Typical applications are DC-DC converters and LED lighting, power management...etc. In the automotive industry they can be used in air bag deployment and in the instrument cluster. The high current gain allows e<sup>2</sup>PowerEdge devices to be driven directly from PMU's control outputs, and the Linear Gain (Beta) makes them ideal components in analog amplifiers.

### Features

- NSV Prefix for Automotive and Other Applications Requiring Unique Site and Control Change Requirements; AEC-Q101 Qualified and PPAP Capable
- NSV60200SMTWTBG – Wettable Flanks Device
- These Devices are Pb-Free, Halogen Free/BFR Free and are RoHS Compliant

### MAXIMUM RATINGS ( $T_A = 25^\circ\text{C}$ )

| Rating                         | Symbol    | Max | Unit |
|--------------------------------|-----------|-----|------|
| Collector-Emitter Voltage      | $V_{CEO}$ | 60  | Vdc  |
| Collector-Base Voltage         | $V_{CBO}$ | 60  | Vdc  |
| Emitter-Base Voltage           | $V_{EBO}$ | 6   | Vdc  |
| Collector Current – Continuous | $I_C$     | 2   | A    |
| Collector Current – Peak       | $I_{CM}$  | 3   | A    |

Stresses exceeding those listed in the Maximum Ratings table may damage the device. If any of these limits are exceeded, device functionality should not be assumed, damage may occur and reliability may be affected.

### THERMAL CHARACTERISTICS

| Characteristic  | Symbol          | Max         | Unit                      |
|---|-----------------|-------------|---------------------------|
| Thermal Resistance Junction-to-Ambient (Note 1)             | $R_{\theta JA}$ | 69          | $^\circ\text{C}/\text{W}$ |
| Total Power Dissipation @ $T_A = 25^\circ\text{C}$ (Note 1) | $P_D$           | 1.8         | W                         |
| Junction and Storage Temperature Range                      | $T_J, T_{stg}$  | -55 to +150 | $^\circ\text{C}$          |

1. Per JESD51-7 with 100 mm<sup>2</sup> pad area and 2 oz. Cu.

60 Volt, 2 Amp  
PNP Low  $V_{CE(sat)}$  Transistor

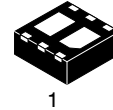

### MARKING DIAGRAM

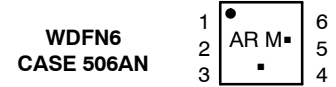

AR = Specific Device Code  
M = Date Code  
▪ = Pb-Free Package

(Note: Microdot may be in either location)

### PIN CONNECTIONS

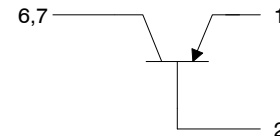
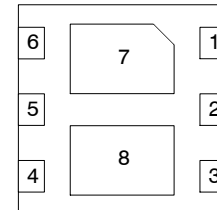

(Pins 3,4,5,8 are not connected)

### ORDERING INFORMATION

| Device          | Package         | Shipping†        |
|-----------------|-----------------|------------------|
| NSS60200SMTTBG  | WDFN6 (Pb-Free) | 3000/Tape & Reel |
| NSV60200SMTWTBG | WDFN6 (Pb-Free) | 3000/Tape & Reel |

†For information on tape and reel specifications, including part orientation and tape sizes, please refer to our Tape and Reel Packaging Specification Brochure, BRD8011/D.

# NSS60200SMT

**Table 1. ELECTRICAL CHARACTERISTICS** ( $T_A = 25^\circ\text{C}$  unless otherwise noted)

| Characteristic  | Symbol        | Min | Typ | Max  | Unit |
|---|---------------|-----|-----|------|------|
| <b>OFF CHARACTERISTICS</b>  |               |     |     |      |      |
| Collector-Emitter Breakdown Voltage ( $I_C = -10\text{ mA}$ , $I_B = 0$ ) | $V_{(BR)CEO}$ | -60 |     |      | V    |
| Collector-Base Breakdown Voltage ( $I_C = -0.1\text{ mA}$ , $I_E = 0$ )   | $V_{(BR)CBO}$ | -80 |     |      | V    |
| Emitter-Base Breakdown Voltage ( $I_E = -0.1\text{ mA}$ , $I_C = 0$ )     | $V_{(BR)EBO}$ | -6  |     |      | V    |
| Collector Cutoff Current ( $V_{CB} = -60\text{ V}$ , $I_E = 0$ )          | $I_{CBO}$     |     |     | -100 | nA   |
| Emitter Cutoff Current ( $V_{BE} = -5.0\text{ V}$ )                       | $I_{EBO}$     |     |     | -100 | nA   |

**ON CHARACTERISTICS**

|   |               |                        |  |  |   |
|---|---------------|------------------------|--|--|---|
| DC Current Gain (Note 2)<br>( $I_C = -100\text{ mA}$ , $V_{CE} = -2.0\text{ V}$ )<br>( $I_C = -500\text{ mA}$ , $V_{CE} = -2.0\text{ V}$ )<br>( $I_C = -1\text{ A}$ , $V_{CE} = -2.0\text{ V}$ )<br>( $I_C = -2\text{ A}$ , $V_{CE} = -2.0\text{ V}$ )  | $h_{FE}$      | 150<br>120<br>90<br>40 | 230<br>180<br>140<br>80                        |  |   |
| Collector-Emitter Saturation Voltage (Note 2)<br>( $I_C = -500\text{ mA}$ , $I_B = -50\text{ mA}$ )<br>( $I_C = -700\text{ mA}$ , $I_B = -7.0\text{ mA}$ )<br>( $I_C = -1\text{ A}$ , $I_B = -50\text{ mA}$ )<br>( $I_C = -1\text{ A}$ , $I_B = -100\text{ mA}$ )<br>( $I_C = -2\text{ A}$ , $I_B = -200\text{ mA}$ ) | $V_{CE(sat)}$ |                        | -0.115<br>-0.295<br>-0.250<br>-0.200<br>-0.365 | -0.160<br>-0.420<br>-0.350<br>-0.300<br>-0.450 | V |
| Base-Emitter Saturation Voltage (Note 2)<br>( $I_C = -500\text{ mA}$ , $I_B = -50\text{ mA}$ )<br>( $I_C = -1\text{ A}$ , $I_B = -50\text{ mA}$ )<br>( $I_C = -1\text{ A}$ , $I_B = -100\text{ mA}$ )   | $V_{BE(sat)}$ |                        |  | -1.0<br>-1.0<br>-1.1                           | V |
| Base-Emitter Turn-on Voltage (Note 2)<br>( $I_C = 500\text{ mA}$ , $I_B = 50\text{ mA}$ )   | $V_{BE(on)}$  |                        |  | -0.9   | V |

**DYNAMIC CHARACTERISTICS**

|   |           |  |     |  |     |
|---|-----------|--|-----|--|-----|
| Output Capacitance<br>( $V_{CB} = 10\text{ V}$ , $f = 1.0\text{ MHz}$ )                       | $C_{obo}$ |  | 18  |  | pF  |
| Cutoff Frequency<br>( $I_C = 50\text{ mA}$ , $V_{CE} = 2.0\text{ V}$ , $f = 100\text{ MHz}$ ) | $f_T$     |  | 155 |  | MHz |

**SWITCHING TIMES**

|   |       |  |     |  |    |
|---|-------|--|-----|--|----|
| Delay Time ( $V_{CC} = -10\text{ V}$ , $I_C = -0.5\text{ A}$ , $I_{B1} = -25\text{ mA}$ , $I_{B2} = 25\text{ mA}$ )   | $t_d$ |  | 15  |  | ns |
| Rise Time ( $V_{CC} = -10\text{ V}$ , $I_C = -0.5\text{ A}$ , $I_{B1} = -25\text{ mA}$ , $I_{B2} = 25\text{ mA}$ )    | $t_r$ |  | 13  |  | ns |
| Storage Time ( $V_{CC} = -10\text{ V}$ , $I_C = -0.5\text{ A}$ , $I_{B1} = -25\text{ mA}$ , $I_{B2} = 25\text{ mA}$ ) | $t_s$ |  | 360 |  | ns |
| Fall Time ( $V_{CC} = -10\text{ V}$ , $I_C = -0.5\text{ A}$ , $I_{B1} = -25\text{ mA}$ , $I_{B2} = 25\text{ mA}$ )    | $t_f$ |  | 22  |  | ns |

Product parametric performance is indicated in the Electrical Characteristics for the listed test conditions, unless otherwise noted. Product performance may not be indicated by the Electrical Characteristics if operated under different conditions.

2. Pulse Condition: Pulse Width = 300  $\mu\text{sec}$ , Duty Cycle  $\leq 2\%$

TYPICAL CHARACTERISTICS

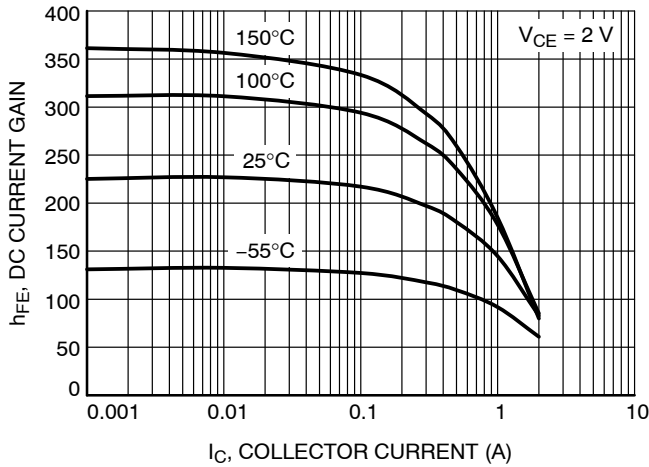

Figure 1. DC Current Gain

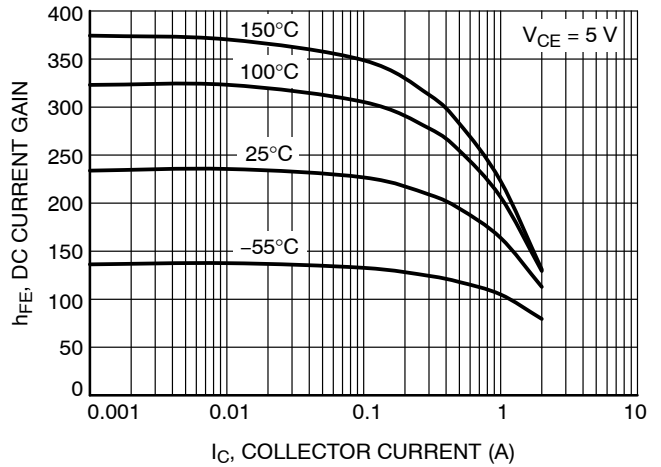

Figure 2. DC Current Gain

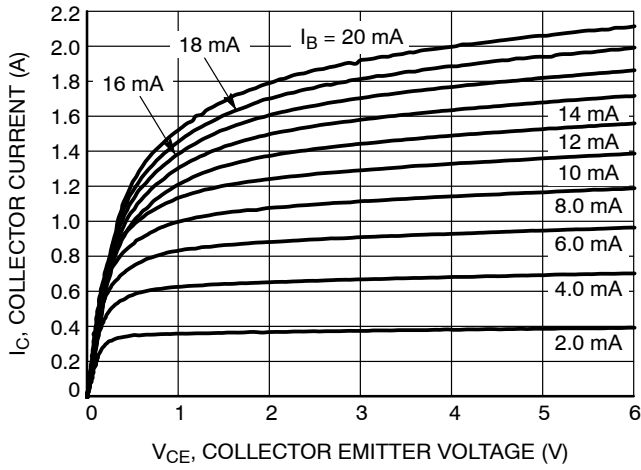

Figure 3. Collector Current as a Function of Collector Emitter Voltage

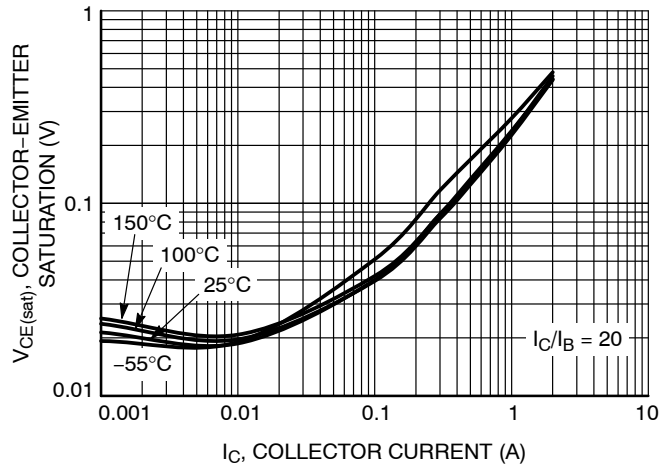

Figure 4. Collector-Emitter Saturation Voltage

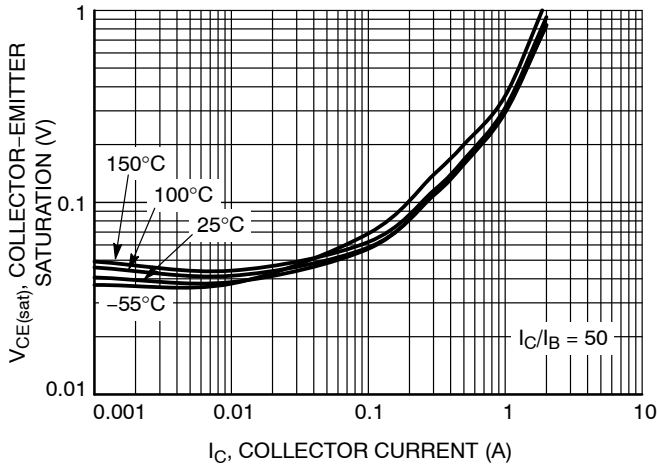

Figure 5. Collector-Emitter Saturation Voltage

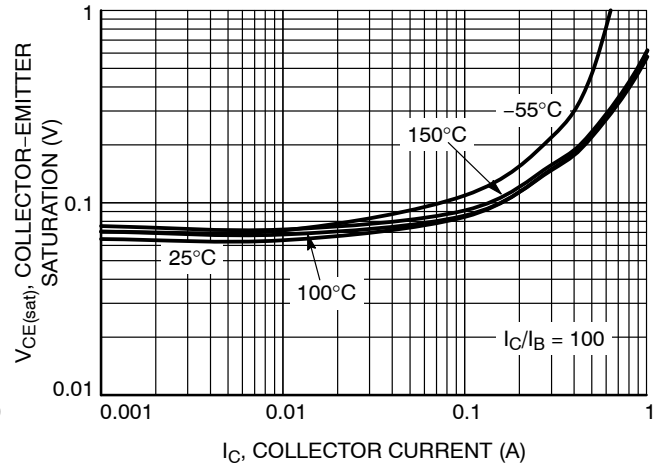

Figure 6. Collector-Emitter Saturation Voltage

# NSS60200SMT

## TYPICAL CHARACTERISTICS

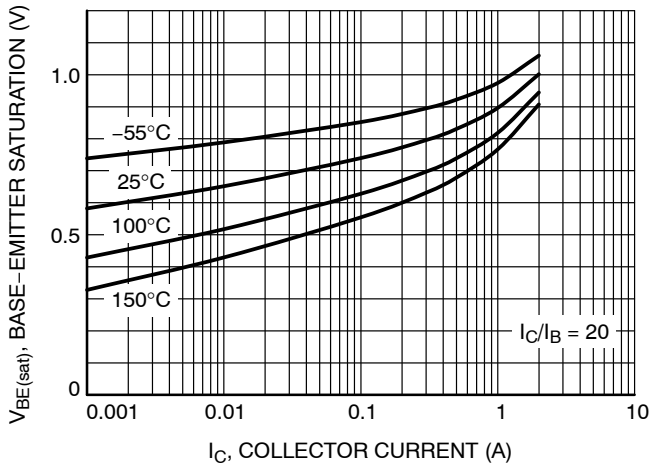

Figure 7. Base-Emitter Saturation Voltage

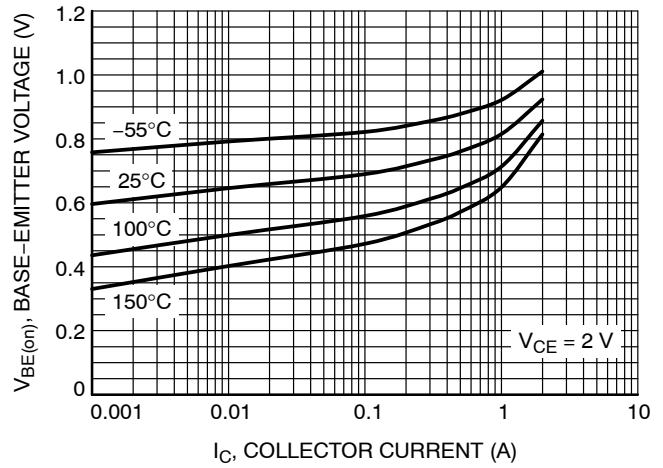

Figure 8. Base-Emitter "ON" Voltage

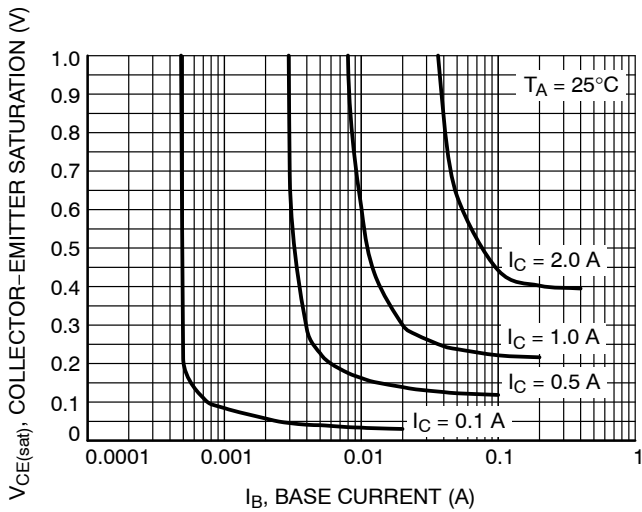

Figure 9. Collector Saturation Region

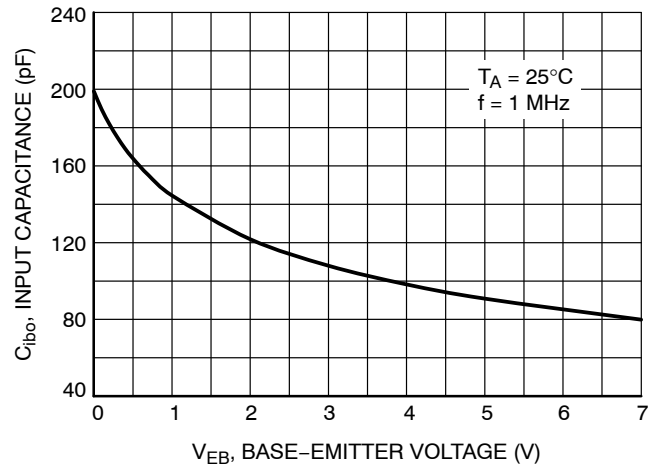

Figure 10. Input Capacitance

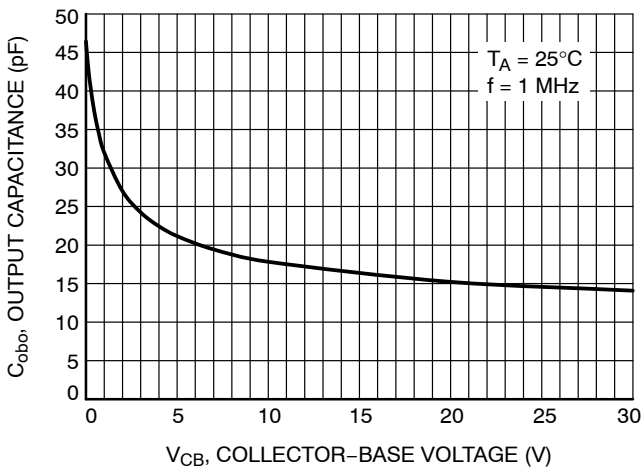

Figure 11. Output Capacitance

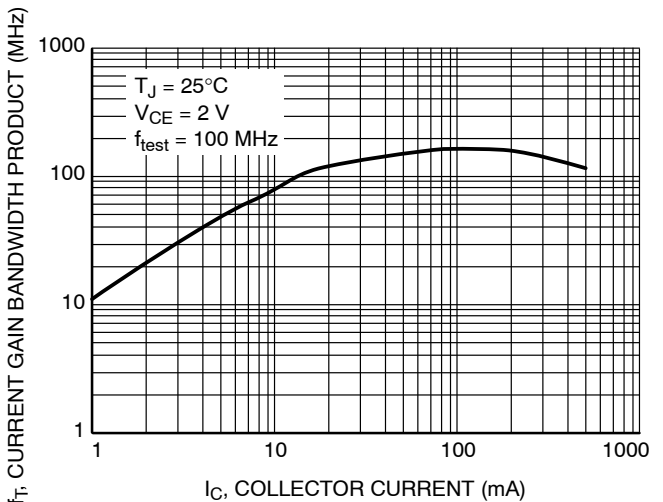

Figure 12.  $f_T$ , Current Gain Bandwidth Product

# NSS60200SMT

## TYPICAL CHARACTERISTICS

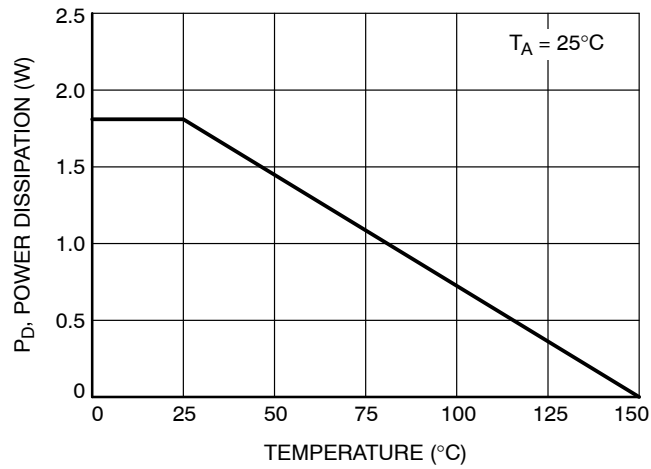

Figure 13. Power Derating

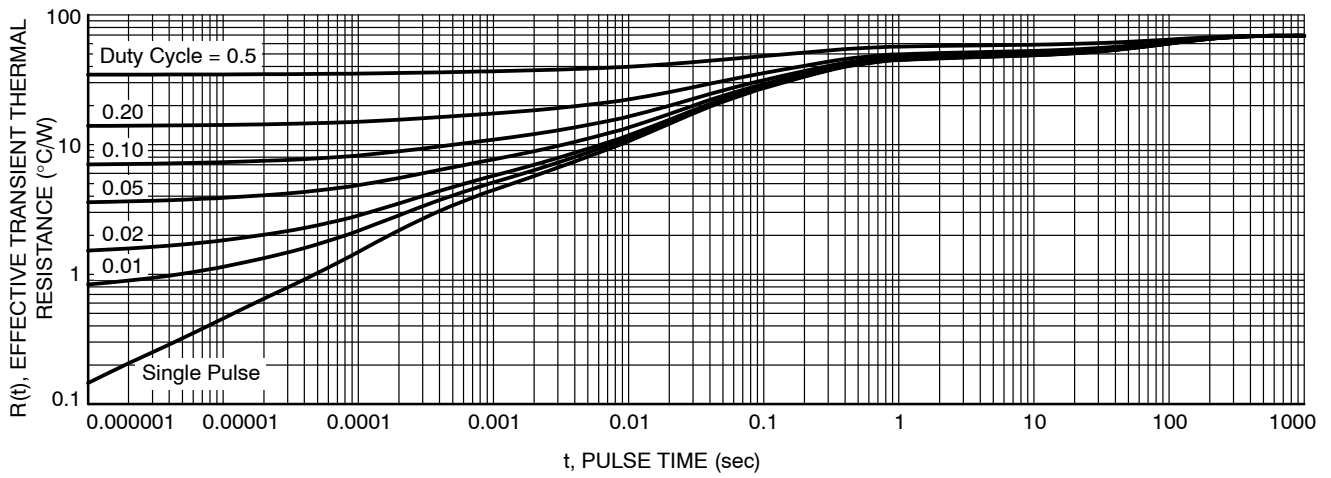
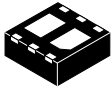

Figure 14. Thermal Resistance by Transistor

# MECHANICAL CASE OUTLINE PACKAGE DIMENSIONS



WDFN6 2x2, 0.65P  
CASE 506AN  
ISSUE H

DATE 25 JAN 2022

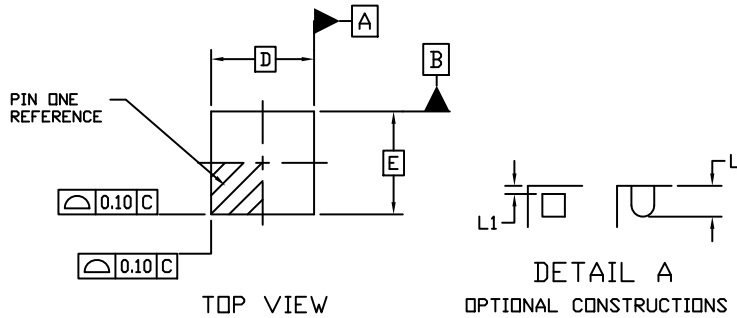

NOTES:

1. DIMENSIONING AND TOLERANCING PER ASME Y14.5M, 1994.
2. CONTROLLING DIMENSION: MILLIMETERS
3. DIMENSION *b* APPLIES TO PLATED TERMINAL AND IS MEASURED BETWEEN 0.15 AND 0.30 MM FROM THE TERMINAL TIP.
4. COPLANARITY APPLIES TO THE EXPOSED PADS AS WELL AS THE TERMINALS.

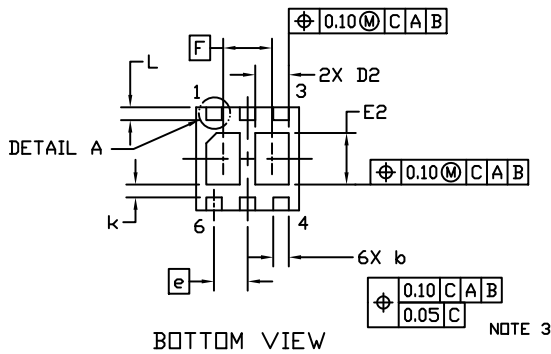
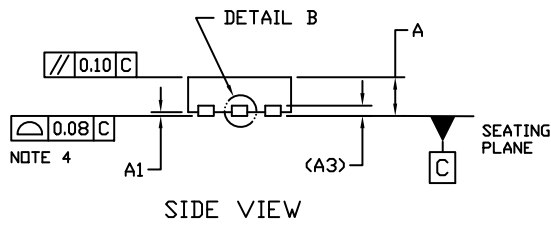

**GENERIC MARKING DIAGRAM\***



XX = Specific Device Code  
M = Date Code

\*This information is generic. Please refer to device data sheet for actual part marking. Pb-Free indicator, "G" or microdot "▪", may or may not be present. Some products may not follow the Generic Marking.

| DIM      | MILLIMETERS |      |
|----------|-------------|------|
|          | MIN.        | MAX. |
| A        | 0.70        | 0.80 |
| A1       | 0.00        | 0.05 |
| A3       | 0.20 REF    |      |
| <i>b</i> | 0.25        | 0.35 |
| D        | 2.00 BSC    |      |
| D2       | 0.57        | 0.77 |
| E        | 2.00 BSC    |      |
| E2       | 0.90        | 1.10 |
| <i>e</i> | 0.65 BSC    |      |
| F        | 0.95 BSC    |      |
| <i>k</i> | 0.25 REF    |      |
| L        | 0.20        | 0.30 |
| L1       | ---         | 0.10 |

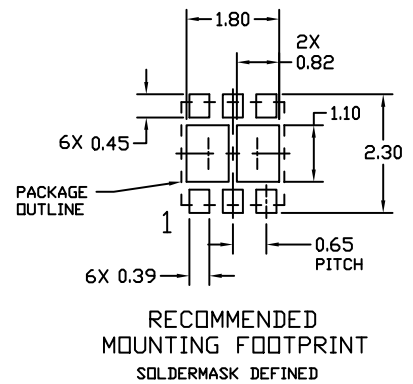

|                         |                         |  |
|-------------------------|-------------------------|--|
| <b>DOCUMENT NUMBER:</b> | <b>98AON20861D</b>      | Electronic versions are uncontrolled except when accessed directly from the Document Repository. Printed versions are uncontrolled except when stamped "CONTROLLED COPY" in red. |
| <b>DESCRIPTION:</b>     | <b>WDFN6 2x2, 0.65P</b> | <b>PAGE 1 OF 1</b>   |

onsemi and ONSEMI are trademarks of Semiconductor Components Industries, LLC dba onsemi or its subsidiaries in the United States and/or other countries. onsemi reserves the right to make changes without further notice to any products herein. onsemi makes no warranty, representation or guarantee regarding the suitability of its products for any particular purpose, nor does onsemi assume any liability arising out of the application or use of any product or circuit, and specifically disclaims any and all liability, including without limitation special, consequential or incidental damages. onsemi does not convey any license under its patent rights nor the rights of others.

**onsemi**, **Onsemi**, and other names, marks, and brands are registered and/or common law trademarks of Semiconductor Components Industries, LLC dba "**onsemi**" or its affiliates and/or subsidiaries in the United States and/or other countries. **onsemi** owns the rights to a number of patents, trademarks, copyrights, trade secrets, and other intellectual property. A listing of **onsemi**'s product/patent coverage may be accessed at [www.onsemi.com/site/pdf/Patent-Marking.pdf](http://www.onsemi.com/site/pdf/Patent-Marking.pdf). **onsemi** reserves the right to make changes at any time to any products or information herein, without notice. The information herein is provided "as-is" and **onsemi** makes no warranty, representation or guarantee regarding the accuracy of the information, product features, availability, functionality, or suitability of its products for any particular purpose, nor does **onsemi** assume any liability arising out of the application or use of any product or circuit, and specifically disclaims any and all liability, including without limitation special, consequential or incidental damages. Buyer is responsible for its products and applications using **onsemi** products, including compliance with all laws, regulations and safety requirements or standards, regardless of any support or applications information provided by **onsemi**. "Typical" parameters which may be provided in **onsemi** data sheets and/or specifications can and do vary in different applications and actual performance may vary over time. All operating parameters, including "Typicals" must be validated for each customer application by customer's technical experts. **onsemi** does not convey any license under any of its intellectual property rights nor the rights of others. **onsemi** products are not designed, intended, or authorized for use as a critical component in life support systems or any FDA Class 3 medical devices or medical devices with a same or similar classification in a foreign jurisdiction or any devices intended for implantation in the human body. Should Buyer purchase or use **onsemi** products for any such unintended or unauthorized application, Buyer shall indemnify and hold **onsemi** and its officers, employees, subsidiaries, affiliates, and distributors harmless against all claims, costs, damages, and expenses, and reasonable attorney fees arising out of, directly or indirectly, any claim of personal injury or death associated with such unintended or unauthorized use, even if such claim alleges that **onsemi** was negligent regarding the design or manufacture of the part. **onsemi** is an Equal Opportunity/Affirmative Action Employer. This literature is subject to all applicable copyright laws and is not for resale in any manner.

## ADDITIONAL INFORMATION

### TECHNICAL PUBLICATIONS:

Technical Library: [www.onsemi.com/design/resources/technical-documentation](http://www.onsemi.com/design/resources/technical-documentation)  
onsemi Website: [www.onsemi.com](http://www.onsemi.com)

### ONLINE SUPPORT: [www.onsemi.com/support](http://www.onsemi.com/support)

For additional information, please contact your local Sales Representative at [www.onsemi.com/support/sales](http://www.onsemi.com/support/sales)