

NSS40501UW3, NSV40501UW3

40 V, 5.0 A, Low $V_{CE(sat)}$ NPN Transistor

ON Semiconductor's e²PowerEdge family of low $V_{CE(sat)}$ transistors are miniature surface mount devices featuring ultra low saturation voltage ($V_{CE(sat)}$) and high current gain capability. These are designed for use in low voltage, high speed switching applications where affordable efficient energy control is important.

Typical applications are DC-DC converters and power management in portable and battery powered products such as cellular and cordless phones, PDAs, computers, printers, digital cameras and MP3 players. Other applications are low voltage motor controls in mass storage products such as disc drives and tape drives. In the automotive industry they can be used in air bag deployment and in the instrument cluster. The high current gain allows e²PowerEdge devices to be driven directly from PMU's control outputs, and the Linear Gain (Beta) makes them ideal components in analog amplifiers.

Features

- NSV Prefix for Automotive and Other Applications Requiring Unique Site and Control Change Requirements; AEC-Q101 Qualified and PPAP Capable
- These Devices are Pb-Free, Halogen Free/BFR Free and are RoHS Compliant

MAXIMUM RATINGS ($T_A = 25^\circ\text{C}$)

| Rating | Symbol | Max | Unit |
|--------------------------------|-----------|----------------------------|------|
| Collector-Emitter Voltage | V_{CEO} | 40 | Vdc |
| Collector-Base Voltage | V_{CBO} | 40 | Vdc |
| Emitter-Base Voltage | V_{EBO} | 6.0 | Vdc |
| Collector Current - Continuous | I_C | 5.0 | Adc |
| Collector Current - Peak | I_{CM} | 7.0 | A |
| Electrostatic Discharge | ESD | HBM Class 3B MM Class C | |

THERMAL CHARACTERISTICS

| Characteristic | Symbol | Max | Unit |
|---|--------------------------|----------------|----------------------------|
| Total Device Dissipation, $T_A = 25^\circ\text{C}$ Derate above 25°C | P_D (Note 1) | 875 7.0 | mW mW/ $^\circ\text{C}$ |
| Thermal Resistance, Junction-to-Ambient | $R_{\theta JA}$ (Note 1) | 143 | $^\circ\text{C}/\text{W}$ |
| Total Device Dissipation, $T_A = 25^\circ\text{C}$ Derate above 25°C | P_D (Note 2) | 1.5 11.8 | W mW/ $^\circ\text{C}$ |
| Thermal Resistance, Junction-to-Ambient | $R_{\theta JA}$ (Note 2) | 85 | $^\circ\text{C}/\text{W}$ |
| Thermal Resistance, Junction-to-Lead #3 | $R_{\theta JL}$ (Note 2) | 23 | $^\circ\text{C}/\text{W}$ |
| Junction and Storage Temperature Range | T_J, T_{stg} | -55 to +150 | $^\circ\text{C}$ |

Stresses exceeding Maximum Ratings may damage the device. Maximum Ratings are stress ratings only. Functional operation above the Recommended Operating Conditions is not implied. Extended exposure to stresses above the Recommended Operating Conditions may affect device reliability.

1. FR-4 @ 100 mm², 1 oz copper traces.
2. FR-4 @ 500 mm², 1 oz copper traces.



ON Semiconductor®

<http://onsemi.com>

40 VOLTS, 5.0 AMPS NPN LOW $V_{CE(sat)}$ TRANSISTOR EQUIVALENT $R_{DS(on)}$ 38 m Ω

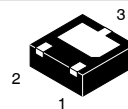
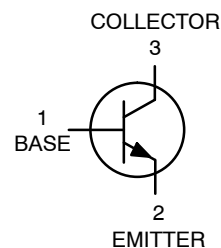

WDFN3
CASE 506AU

MARKING DIAGRAM

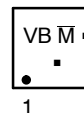

VB = Specific Device Code
M = Date Code
■ = Pb-Free Package

(Note: Microdot may be in either location)

ORDERING INFORMATION

| Device | Package | Shipping† |
|----------------|--------------------|----------------------|
| NSS40501UW3T2G | WDFN3 (Pb-Free) | 3000/ Tape & Reel |
| NSV40501UW3T2G | WDFN3 (Pb-Free) | 3000/ Tape & Reel |

†For information on tape and reel specifications, including part orientation and tape sizes, please refer to our Tape and Reel Packaging Specifications Brochure, BRD8011/D.

NSS40501UW3, NSV40501UW3

ELECTRICAL CHARACTERISTICS (T_A = 25°C unless otherwise noted)

| Characteristic | Symbol | Min | Typical | Max | Unit |
|---|----------------------|---------------------------------|--|--|------|
| OFF CHARACTERISTICS | | | | | |
| Collector – Emitter Breakdown Voltage (I _C = 10 mAdc, I _B = 0) | V _{(BR)CEO} | 40 | – | – | Vdc |
| Collector – Base Breakdown Voltage (I _C = 0.1 mAdc, I _E = 0) | V _{(BR)CBO} | 40 | – | – | Vdc |
| Emitter – Base Breakdown Voltage (I _E = 0.1 mAdc, I _C = 0) | V _{(BR)EBO} | 6.0 | – | – | Vdc |
| Collector Cutoff Current (V _{CB} = 40 Vdc, I _E = 0) | I _{CBO} | – | – | 0.1 | μAdc |
| Emitter Cutoff Current (V _{EB} = 6.0 Vdc) | I _{EBO} | – | – | 0.1 | μAdc |
| ON CHARACTERISTICS | | | | | |
| DC Current Gain (Note 3) (I _C = 10 mA, V _{CE} = 2.0 V) (I _C = 500 mA, V _{CE} = 2.0 V) (I _C = 1.0 A, V _{CE} = 2.0 V) (I _C = 2.0 A, V _{CE} = 2.0 V) (I _C = 3.0 A, V _{CE} = 2.0 V) | h _{FE} | 200 200 200 200 180 | – – 320 305 295 | – – – – – | |
| Collector – Emitter Saturation Voltage (Note 3) (I _C = 0.1 A, I _B = 0.010 A) (I _C = 1.0 A, I _B = 0.100 A) (I _C = 1.0 A, I _B = 0.010 A) (I _C = 2.0 A, I _B = 0.020 A) (I _C = 3.0 A, I _B = 0.030 A) (I _C = 4.0 A, I _B = 0.400 A) | V _{CE(sat)} | – – – – – – | 0.006 0.038 0.060 0.097 0.130 0.110 | 0.010 0.045 0.080 0.120 0.160 0.150 | V |
| Base – Emitter Saturation Voltage (Note 3) (I _C = 1.0 A, I _B = 0.01 A) | V _{BE(sat)} | – | 0.760 | 0.900 | V |
| Base – Emitter Turn-on Voltage (Note 3) (I _C = 2.0 A, V _{CE} = 2.0 V) | V _{BE(on)} | – | 0.730 | 0.900 | V |
| Cutoff Frequency (I _C = 100 mA, V _{CE} = 5.0 V, f = 100 MHz) | f _T | 150 | – | – | MHz |
| Input Capacitance (V _{EB} = 0.5 V, f = 1.0 MHz) | C _{ibo} | – | | 650 | pF |
| Output Capacitance (V _{CB} = 3.0 V, f = 1.0 MHz) | C _{obo} | – | | 70 | pF |
| SWITCHING CHARACTERISTICS | | | | | |
| Delay (V _{CC} = 30 V, I _C = 750 mA, I _{B1} = 15 mA) | t _d | – | – | 90 | ns |
| Rise (V _{CC} = 30 V, I _C = 750 mA, I _{B1} = 15 mA) | t _r | – | – | 100 | ns |
| Storage (V _{CC} = 30 V, I _C = 750 mA, I _{B1} = 15 mA) | t _s | – | – | 1050 | ns |
| Fall (V _{CC} = 30 V, I _C = 750 mA, I _{B1} = 15 mA) | t _f | – | – | 100 | ns |

3. Pulsed Condition: Pulse Width = 300 μsec, Duty Cycle ≤ 2%.

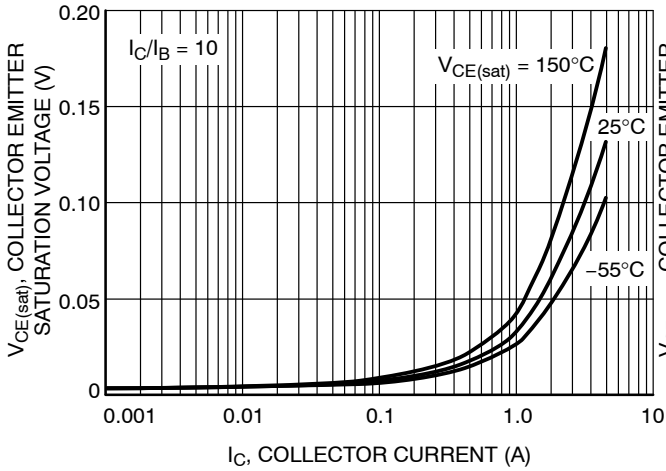

Figure 1. Collector Emitter Saturation Voltage vs. Collector Current

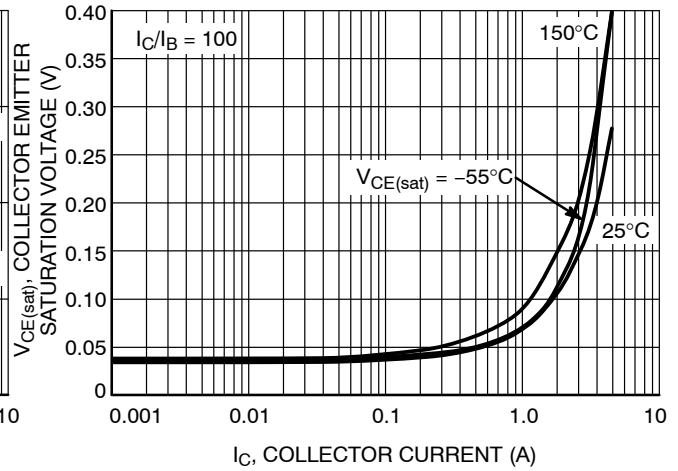

Figure 2. Collector Emitter Saturation Voltage vs. Collector Current

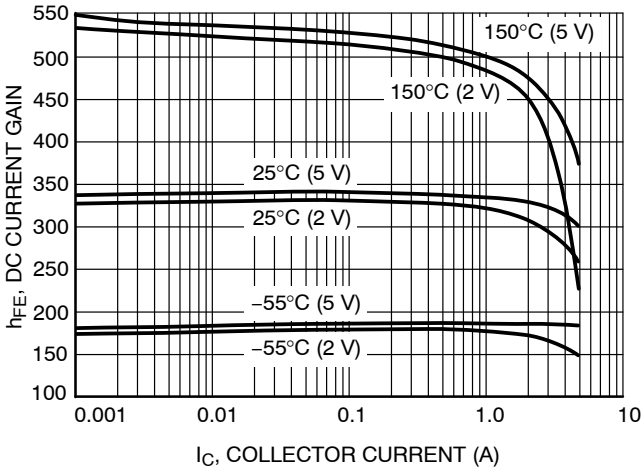

Figure 3. DC Current Gain vs. Collector Current

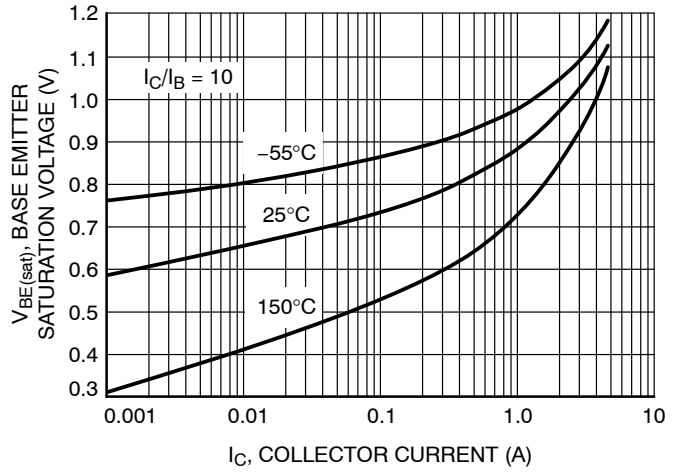

Figure 4. Base Emitter Saturation Voltage vs. Collector Current

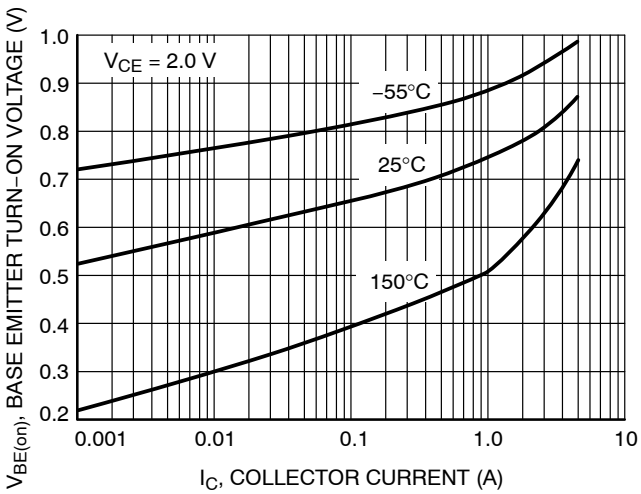

Figure 5. Base Emitter Turn-On Voltage vs. Collector Current

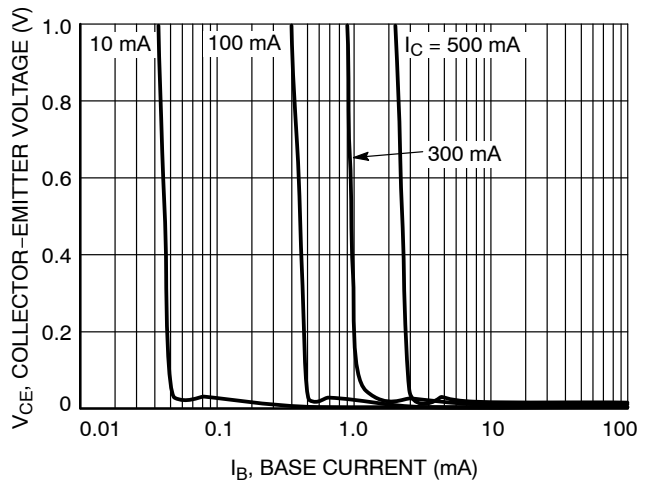

Figure 6. Saturation Region

NSS40501UW3, NSV40501UW3

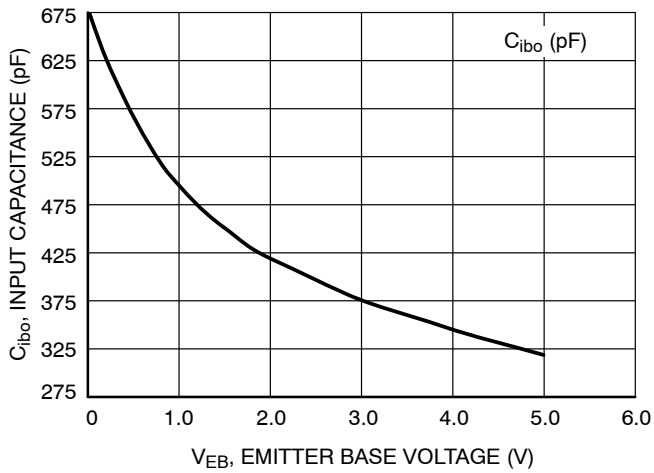

Figure 7. Input Capacitance

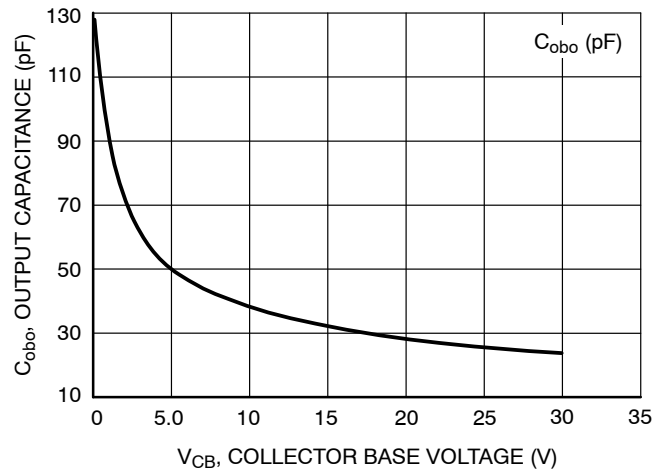

Figure 8. Output Capacitance

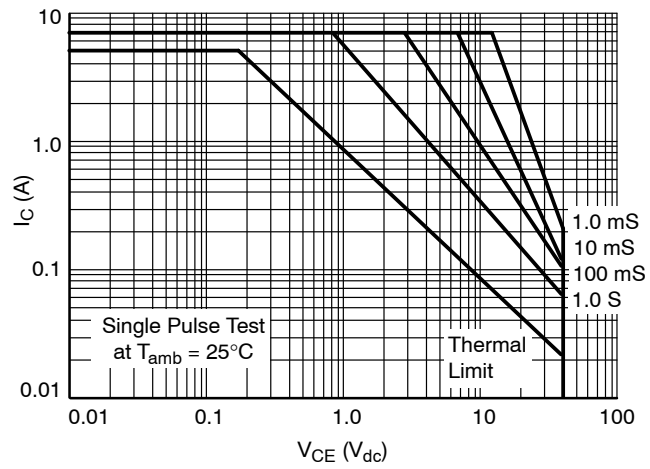

Figure 9. Safe Operating Area

MECHANICAL CASE OUTLINE

PACKAGE DIMENSIONS

ON Semiconductor®



WDFN3 2x2, 1.3P CASE 506AU ISSUE A

DATE 18 AUG 2016



SCALE 4:1



NOTES:

1. DIMENSIONING AND TOLERANCING PER ASME Y14.5M, 1994.
2. CONTROLLING DIMENSION: MILLIMETERS.
3. DIMENSION b APPLIES TO PLATED TERMINAL AND IS MEASURED BETWEEN 0.25 AND 0.30 MM FROM TERMINAL.
4. COPLANARITY APPLIES TO THE EXPOSED PAD AS WELL AS THE TERMINALS.

| DIM | MILLIMETERS | | | INCHES | | |
|-----|-------------|----------|------|--------|-----------|-------|
| | MIN | NOM | MAX | MIN | NOM | MAX |
| A | 0.70 | 0.75 | 0.80 | 0.028 | 0.030 | 0.031 |
| A1 | 0.00 | | 0.05 | 0.000 | | 0.002 |
| A3 | | 0.20 REF | | | 0.008 REF | |
| b | 0.25 | 0.30 | 0.35 | 0.010 | 0.012 | 0.014 |
| D | | 2.00 BSC | | | 0.079 BSC | |
| D2 | 1.40 | 1.50 | 1.60 | 0.055 | 0.059 | 0.063 |
| E | | 2.00 BSC | | | 0.079 BSC | |
| E2 | 0.90 | 1.00 | 1.10 | 0.035 | 0.039 | 0.043 |
| e | | 1.30 BSC | | | 0.051 BSC | |
| K | | 0.35 REF | | | 0.014 REF | |
| L | 0.35 | 0.40 | 0.45 | 0.014 | 0.016 | 0.018 |

GENERIC MARKING DIAGRAM*



XX = Specific Device Code
M = Date Code

*This information is generic. Please refer to device data sheet for actual part marking.

Pb-Free indicator, "G" or microdot "•", may or may not be present.

SOLDERING FOOTPRINT*

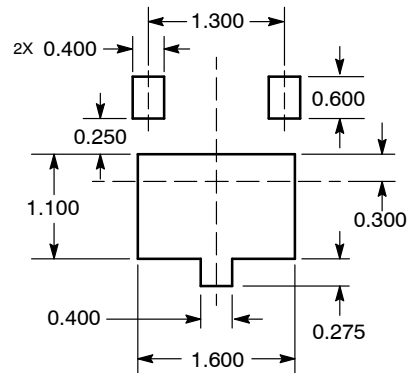

DIMENSIONS: MILLIMETERS

*For additional information on our Pb-Free strategy and soldering details, please download the ON Semiconductor Soldering and Mounting Techniques Reference Manual, SOLDERRM/D.

| | | |
|-------------------------|------------------------|--|
| DOCUMENT NUMBER: | 98AON21416D | Electronic versions are uncontrolled except when accessed directly from the Document Repository. Printed versions are uncontrolled except when stamped "CONTROLLED COPY" in red. |
| DESCRIPTION: | WDFN3 2X2, 1.3P | PAGE 1 OF 1 |

ON Semiconductor and ON are trademarks of Semiconductor Components Industries, LLC dba ON Semiconductor or its subsidiaries in the United States and/or other countries. ON Semiconductor reserves the right to make changes without further notice to any products herein. ON Semiconductor makes no warranty, representation or guarantee regarding the suitability of its products for any particular purpose, nor does ON Semiconductor assume any liability arising out of the application or use of any product or circuit, and specifically disclaims any and all liability, including without limitation special, consequential or incidental damages. ON Semiconductor does not convey any license under its patent rights nor the rights of others.

onsemi, **Onsemi**, and other names, marks, and brands are registered and/or common law trademarks of Semiconductor Components Industries, LLC dba "**onsemi**" or its affiliates and/or subsidiaries in the United States and/or other countries. **onsemi** owns the rights to a number of patents, trademarks, copyrights, trade secrets, and other intellectual property. A listing of **onsemi**'s product/patent coverage may be accessed at www.onsemi.com/site/pdf/Patent-Marking.pdf. **onsemi** reserves the right to make changes at any time to any products or information herein, without notice. The information herein is provided "as-is" and **onsemi** makes no warranty, representation or guarantee regarding the accuracy of the information, product features, availability, functionality, or suitability of its products for any particular purpose, nor does **onsemi** assume any liability arising out of the application or use of any product or circuit, and specifically disclaims any and all liability, including without limitation special, consequential or incidental damages. Buyer is responsible for its products and applications using **onsemi** products, including compliance with all laws, regulations and safety requirements or standards, regardless of any support or applications information provided by **onsemi**. "Typical" parameters which may be provided in **onsemi** data sheets and/or specifications can and do vary in different applications and actual performance may vary over time. All operating parameters, including "Typicals" must be validated for each customer application by customer's technical experts. **onsemi** does not convey any license under any of its intellectual property rights nor the rights of others. **onsemi** products are not designed, intended, or authorized for use as a critical component in life support systems or any FDA Class 3 medical devices or medical devices with a same or similar classification in a foreign jurisdiction or any devices intended for implantation in the human body. Should Buyer purchase or use **onsemi** products for any such unintended or unauthorized application, Buyer shall indemnify and hold **onsemi** and its officers, employees, subsidiaries, affiliates, and distributors harmless against all claims, costs, damages, and expenses, and reasonable attorney fees arising out of, directly or indirectly, any claim of personal injury or death associated with such unintended or unauthorized use, even if such claim alleges that **onsemi** was negligent regarding the design or manufacture of the part. **onsemi** is an Equal Opportunity/Affirmative Action Employer. This literature is subject to all applicable copyright laws and is not for resale in any manner.

ADDITIONAL INFORMATION

TECHNICAL PUBLICATIONS:

Technical Library: www.onsemi.com/design/resources/technical-documentation
onsemi Website: www.onsemi.com

ONLINE SUPPORT: www.onsemi.com/support

For additional information, please contact your local Sales Representative at www.onsemi.com/support/sales