

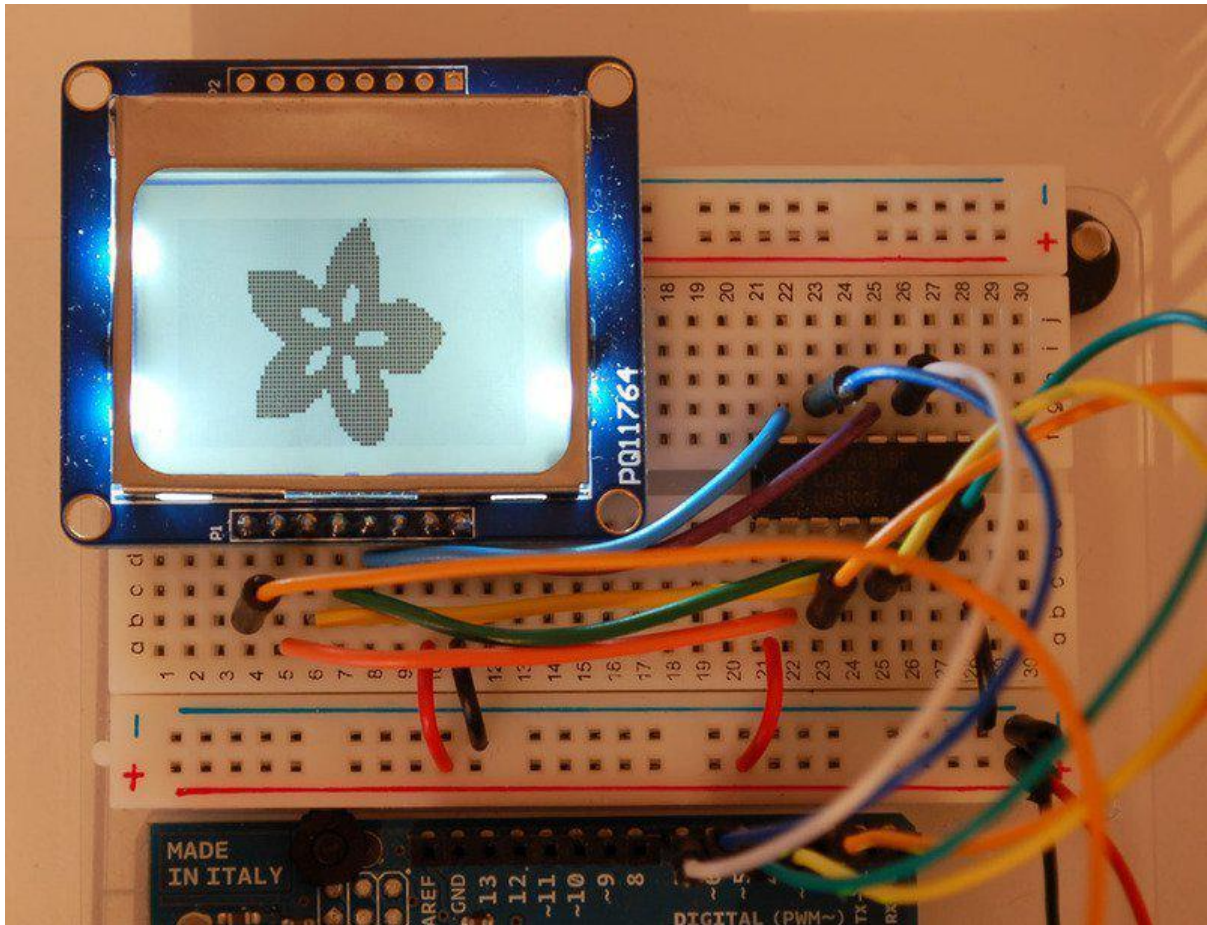

Nokia 5110/3310 Monochrome LCD

Created by lady ada



<https://learn.adafruit.com/nokia-5110-3310-monochrome-lcd>

Last updated on 2023-08-29 02:14:23 PM EDT

Table of Contents

Overview	3
Power Requirements	4
Arduino Wiring	4
• Dimmable Backlight Option:	
Arduino Testing	10
Graphics Library	12
Wiring (fewer pins)	13
CircuitPython Wiring	13
CircuitPython Setup	14
• CircuitPython Installation of PCD8544 Library	
CircuitPython Usage	15
• Initialization	
• Controlling the Backlight LED	
• Contrast and Bias	
• Drawing	
• Text	
• Invert	
• Full Example Code	
Python Wiring	22
Python Setup	23
• Python Installation of PCD8544 Library	
• DejaVu TTF Font	
• Pillow Library	
Python Usage	24
• Initialization	
• Controlling the Backlight LED	
• Contrast and Bias	
• Example Code	
Downloads	30

Overview

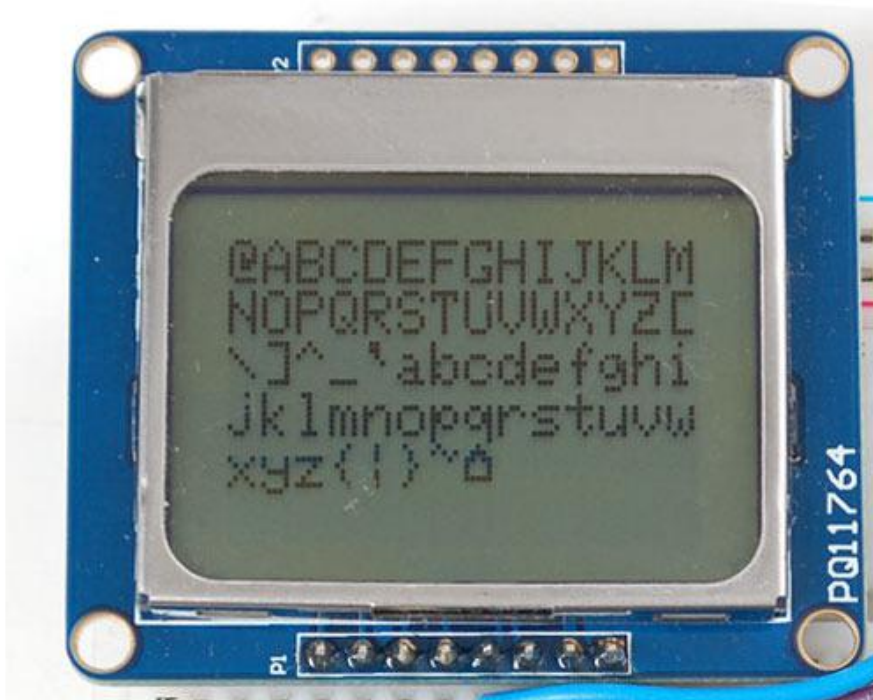
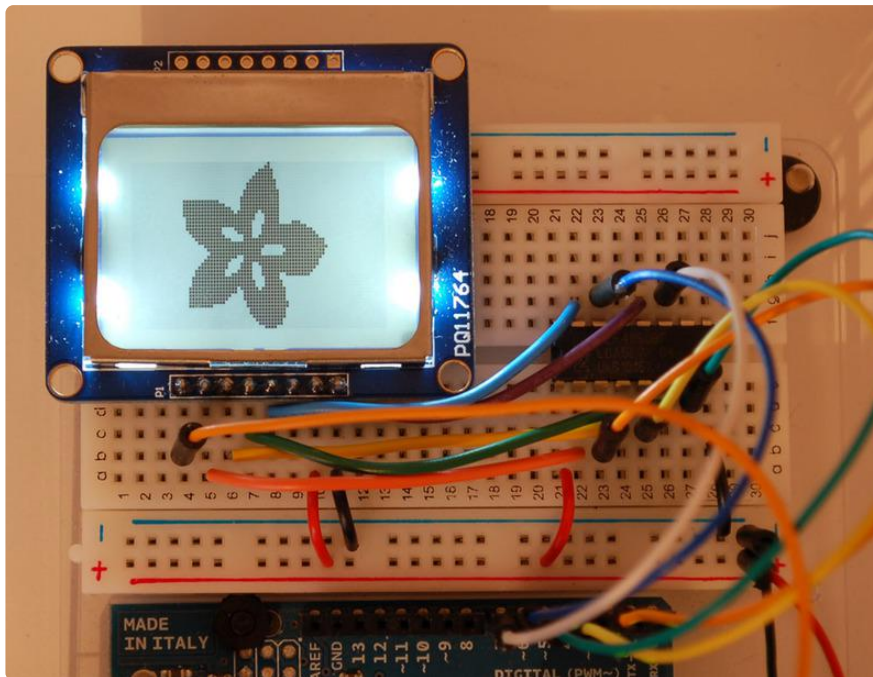

This is a quick tutorial for our 84x48 pixel monochrome LCD display. These displays are small, only about 1.5" diameter, but very readable due and comes with a backlight. This display is made of 84x48 individual pixels, so you can use it for graphics, text or bitmaps. These displays are inexpensive, easy to use, require only a few digital I/O pins and are fairly low power as well.

To drive the display, you will need 3 to 5 digital output pins (depending on whether

you want to manually control the chip select and reset lines). Another pin can be used to control (via on/off or PWM) the backlight. To make things easy for you, we've written a nice graphics library that can print text, pixels, rectangles, circles and lines! The library is written for the Arduino but can easily be ported to your favorite microcontroller.

[You can pick up one of these displays at the adafruit shop! \(\)](#)

Power Requirements

The display uses the PCD8544 controller chip from Philips and were used in Nokia 3310 and 5110 cell phones. This chip is designed to run only at 3.3V and have 3v communication levels, so for 5V microcontrollers a logic level shifter is required (otherwise you could easily damage the display).

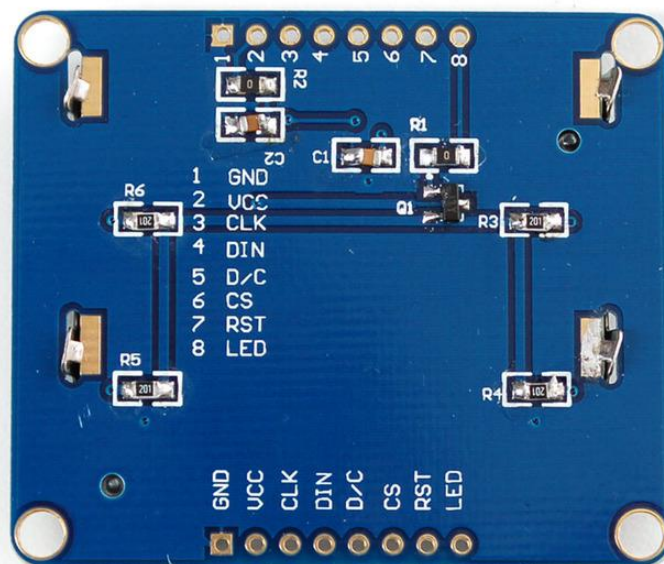

If you want to use the backlight, that can draw up to 80mA (4 white LEDs at 20mA each). The backlight pin is connected to a transistor so you can PWM all 4 LEDs at once from a microcontroller pin.

Arduino Wiring

The LCD runs at 3.3V so you'll need to use a level shifting chip to use with a 5V microcontroller. The following will assume that is the case. If you're running a 3.3V microcontroller system, you can skip the level shifter.

We'll assume you want to use this in a breadboard, take a piece of 0.1" header 8 pins

long and insert it into a breadboard.

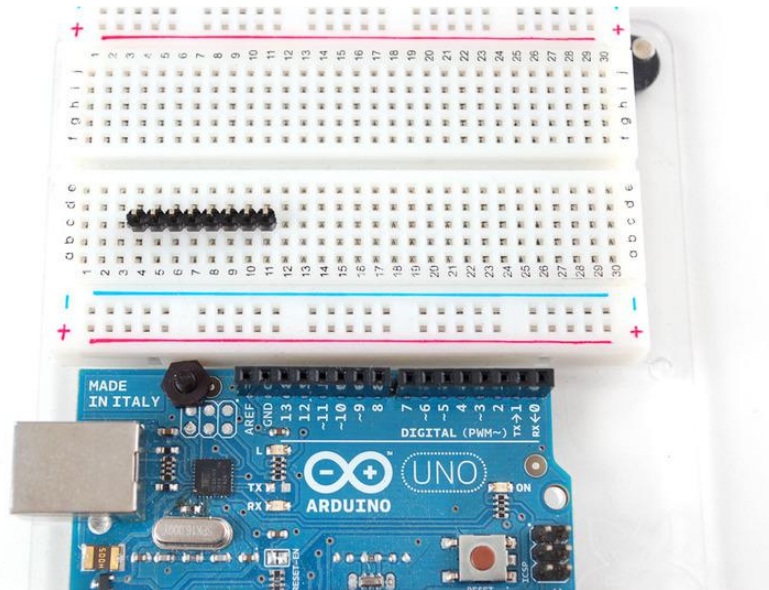

Slide either side of the LCD onto the header, the 'thicker' end is the top.

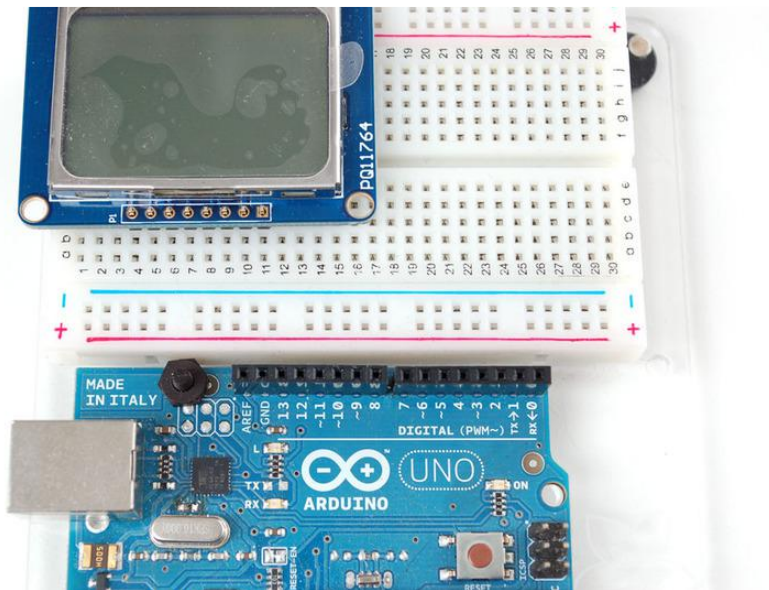

Solder all the pins.

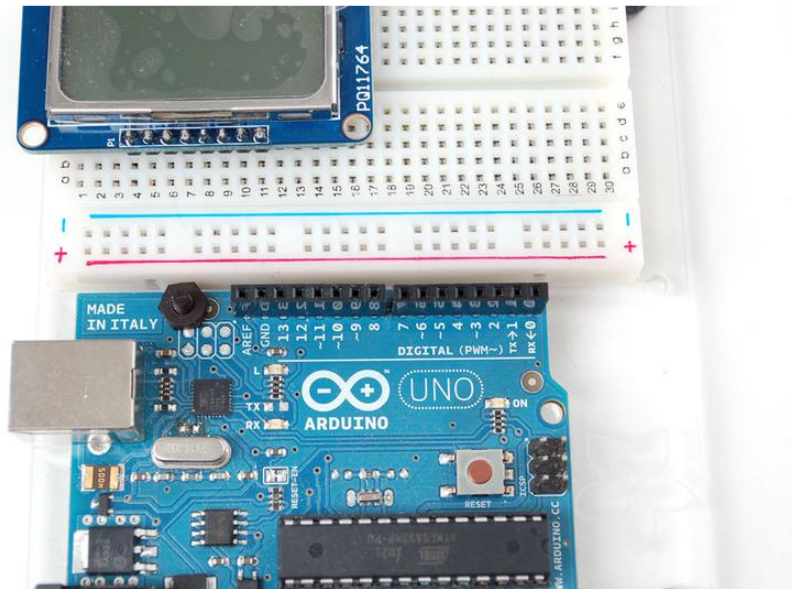
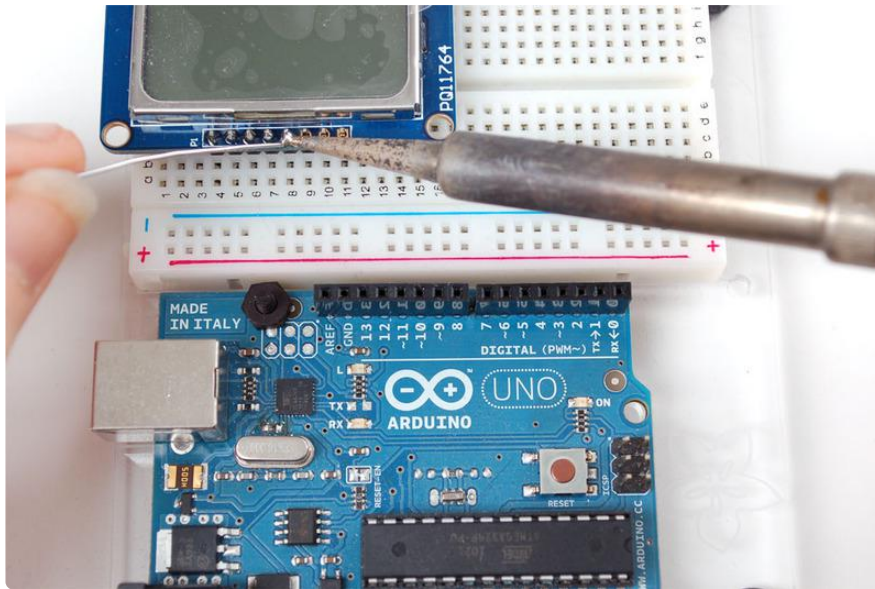

Place the level shifter chip off to the side. Pin 1 is on the left here.

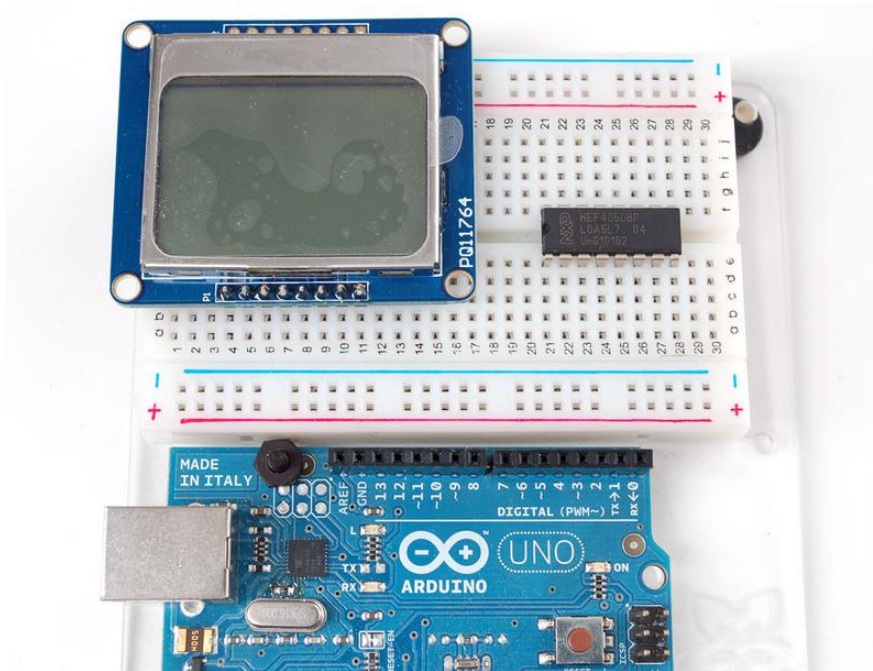

We'll start with the power lines. the system must be powered by 3.3V so red here is connected to the 3V pin from the Arduino. Ground is black.

- Connect pin 1 of the 4050, the LCD VCC pin and the LCD backlight pin to 3.3V.
- Connect pin 8 of the 4050 and the GND pin of the LCD to ground.

Verify you see the backlight LEDs light up

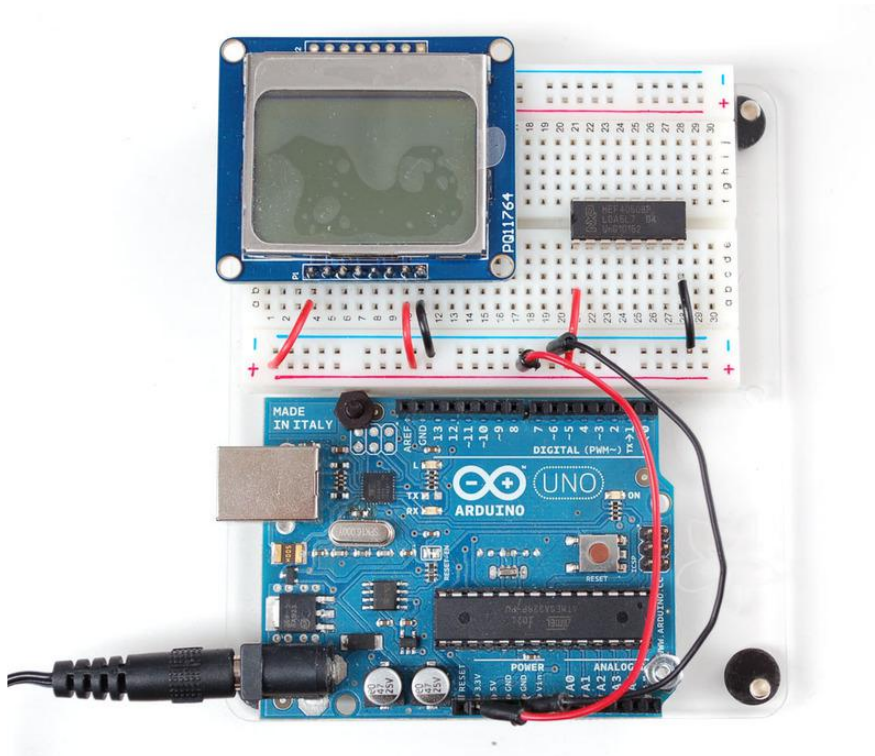

Dimmable Backlight Option:

Newer versions of these boards have a slightly different backlight circuit that is brighter than the older boards. You can add a pot to the backlight so that you can control the brightness. (This works with the older boards too, but the range of brightness will be lower).

The optional pot can be wired as in the photo below:

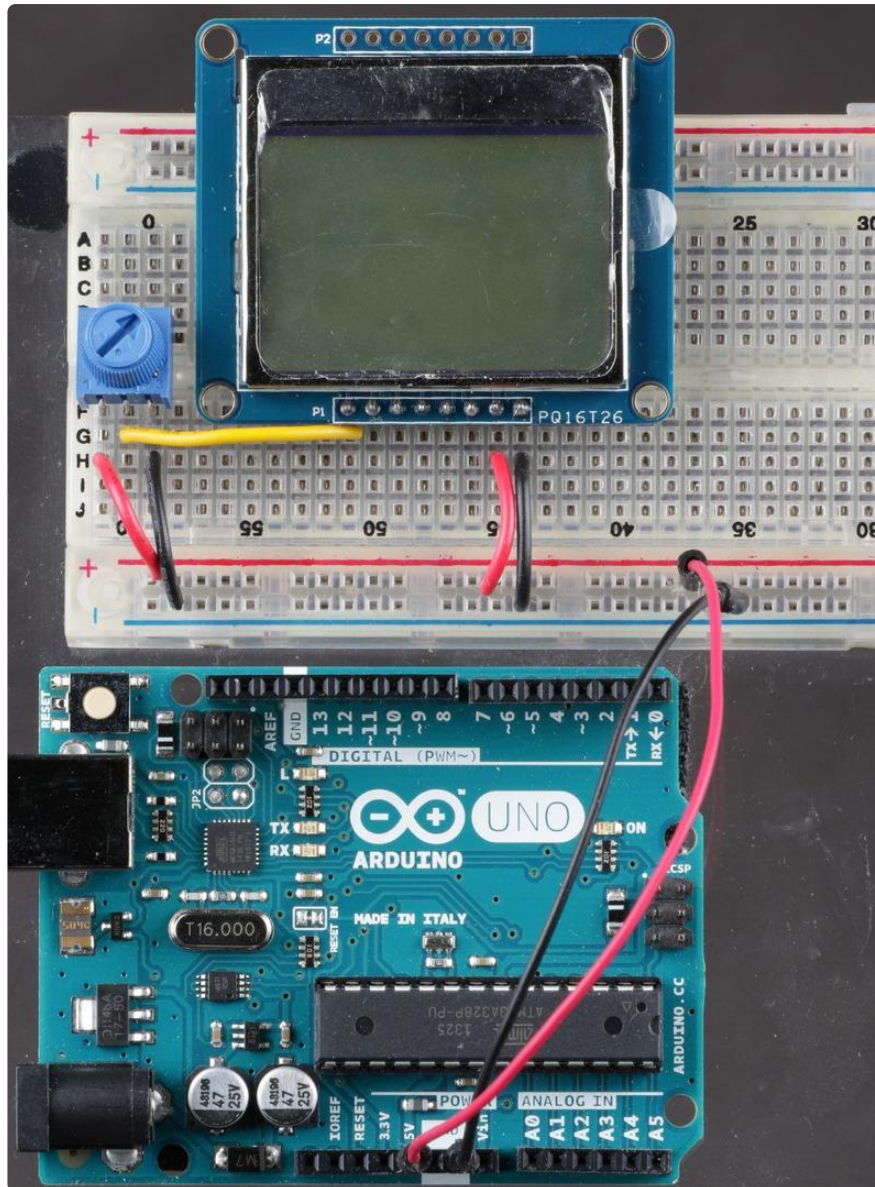

Next we'll start wiring up the data lines.

- Connect the RST (reset) pin of the LCD (orange wire) to pin 2 of the 4050
- Connect the CS (chip select) pin (yellow wire) to pin 4 of the 4050.
- Connect the D/C (data/command) pin (green wire) to pin 6 of the 4050.

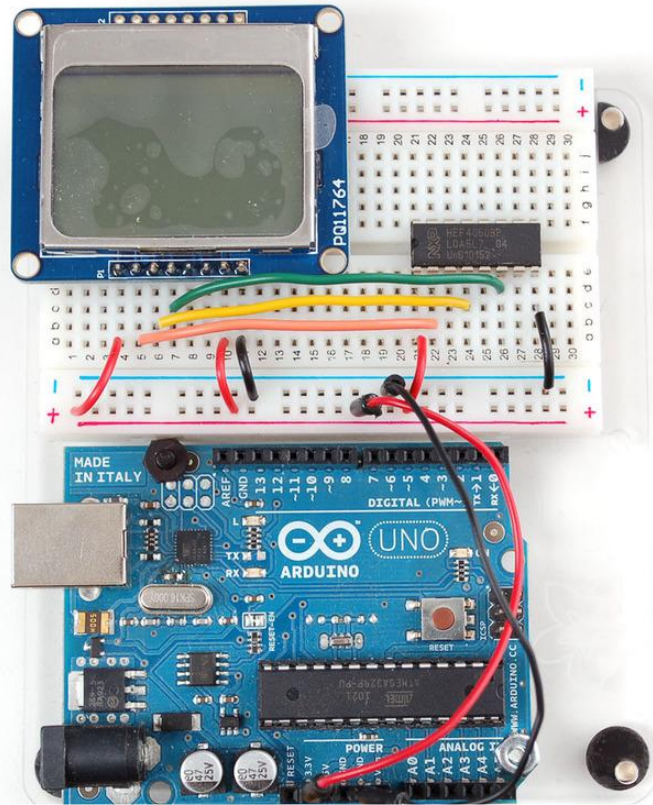

Next, connect:

- DIN (data in) pin (blue wire) to pin 15 of the 4050
- CLK(clock) pin (purple wire) to pin 12 of the 4050.

Then we can connect the data lines from the arduino to the LCD. We can use any 5 pins but you may want to start with our example first.

- Arduino pin 3 (orange) goes to pin 3 of the 4050.
- Arduino pin 4 (yellow) goes to pin 5 of the 4050.
- Arduino pin 5 (green) goes to pin 7 of the 4050.
- Arduino pin 6 (blue) goes to pin 14 of the 4050.
- Arduino pin 7 (violet) goes to pin 11 of the 4050.

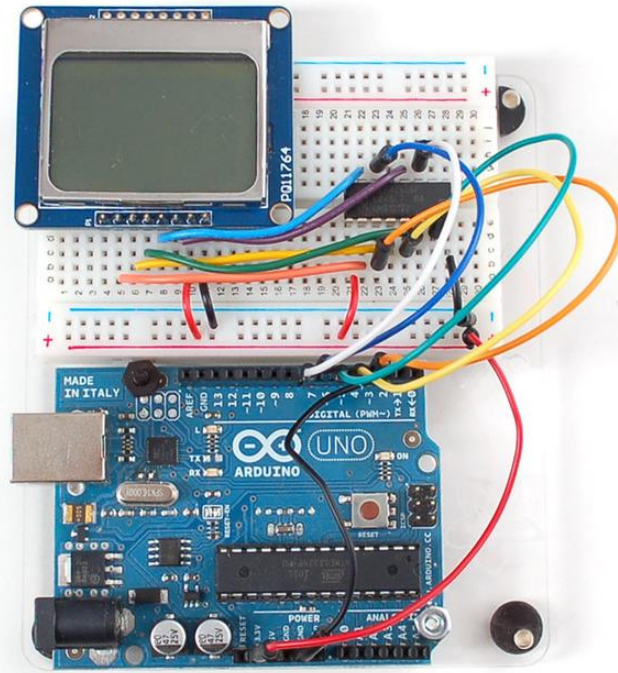

Now you are ready to test!

Arduino Testing

You can find our [Nokia Display Arduino library on github \(\)](#). You should install it through the Arduino Library Manager.

Open up the Arduino Library Manager:

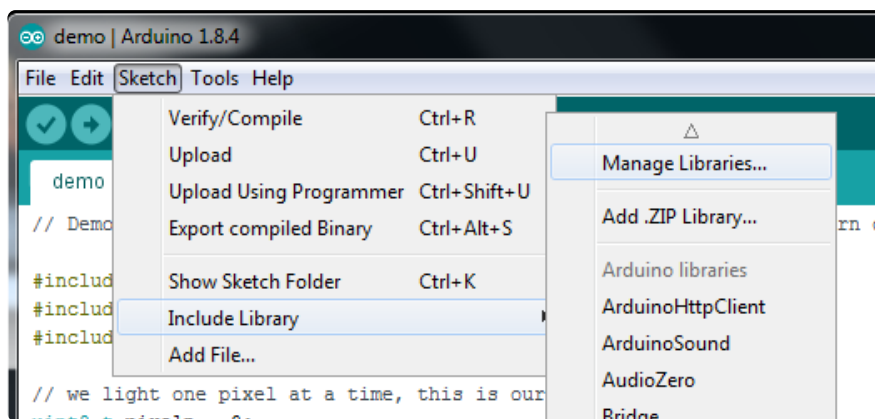

Search for the Adafruit PCD8544 library and install it



Search for the Adafruit GFX library and install it

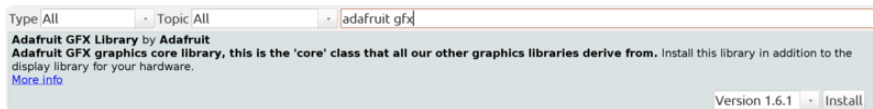

If using an earlier version of the Arduino IDE (prior to 1.8.10), also locate and install Adafuit_BusIO (newer versions will install this dependency automatically).

We also have a great tutorial on Arduino library installation at:

<http://learn.adafruit.com/adafruit-all-about-arduino-libraries-install-use>

You should see the pcdtest example in File>Examples>Adafruit PCD8544 Nokia 5110 LCD library. Load that example and flash it to your Arduino

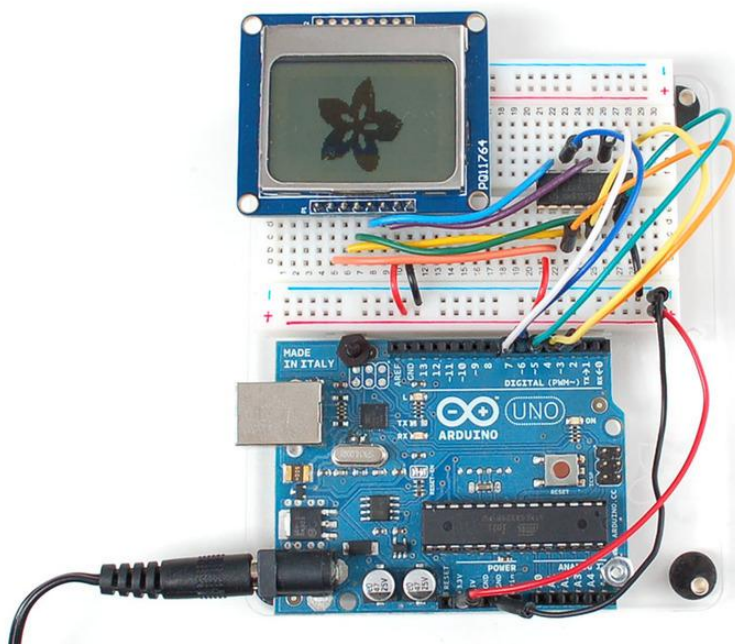

You can control the backlight, its much brighter when you connect the backlight pin to 5V (you don't need a level shifter if you are using a Nokia display from Adafruit). You can control the backlight using an Arduino pin since there is a transistor on the board.

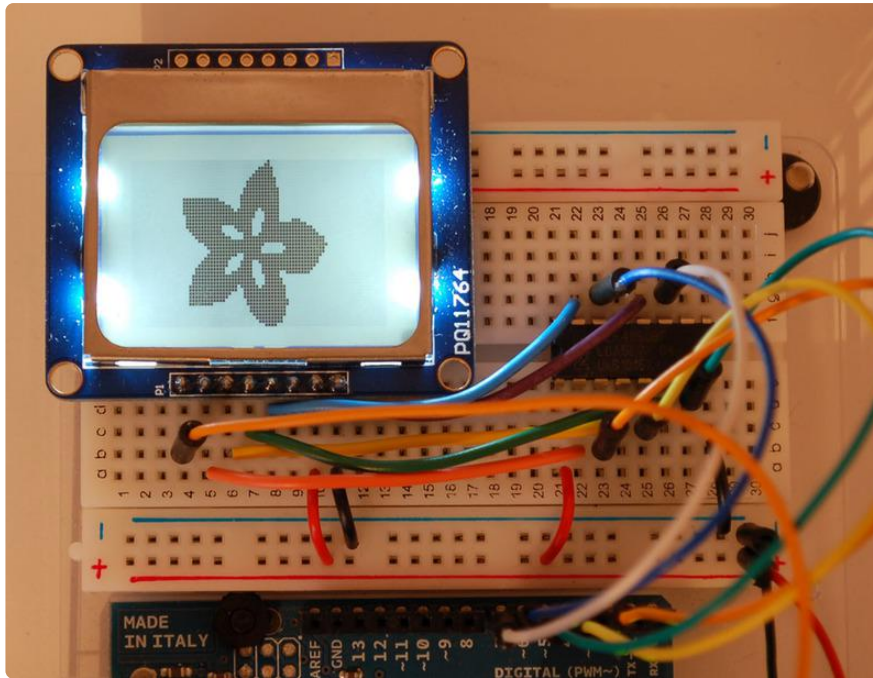

Graphics Library

We have a ready to go basic graphics library that has primitives for bitmaps, shapes and text. You can probably do everything you want using it. Because of the way the display works we need to buffer the entire display in ram which is 84x48 bits (504 bytes). However, screen updates are very fast.

For more details about the Adafruit GFX library, please visit <http://learn.adafruit.com/adafruit-gfx-graphics-library> () - it supports lines, rectangles, roundrects, circles, text of different sizes etc.

Note that since this display is MONOCHROMATIC it only supports two colors: BLACK or WHITE. BLACK is a displayed dot and WHITE is for erasing pixels

Dont forget, after drawing anything to the screen, call `display()` to write it out to the LCD!

Wiring (fewer pins)

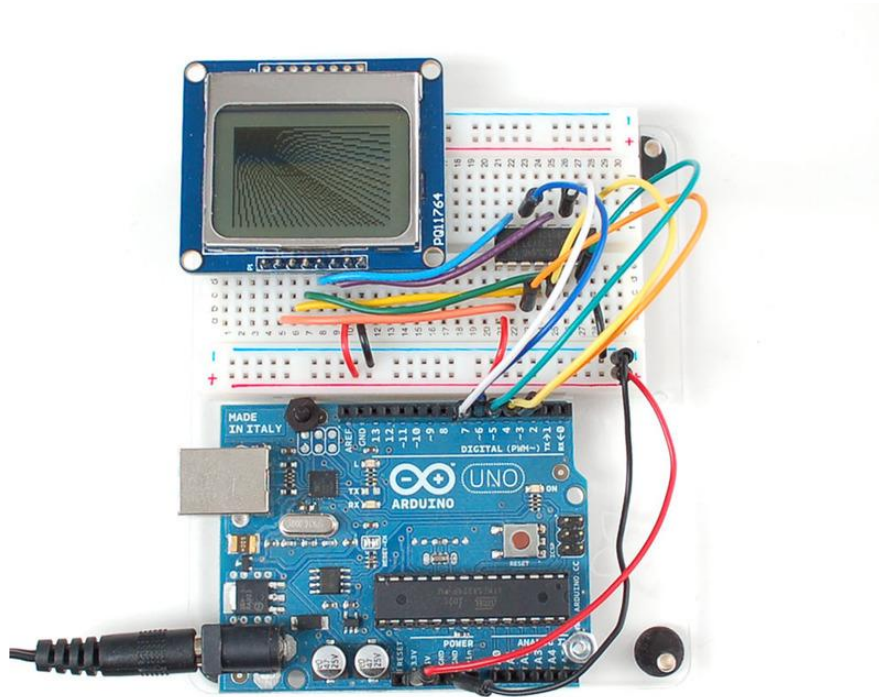

You can save some pins by connecting the CS pin to ground (this means you cant reuse the LCD's pins between screen updates but maybe thats OK. You can also connect the RST pin to the Arduino reset so that it will reset the screen automatically.

CircuitPython Wiring

It's easy to use the Nokia 5110/3310 LCD with CircuitPython and the [Adafruit CircuitPython PCD8544 \(\)](#) module. This module allows you to easily write Python code to control the display.

You can use this sensor with any CircuitPython microcontroller board or with a computer that has GPIO and Python [thanks to Adafruit_Blinka, our CircuitPython-for-Python compatibility library \(\)](#).

We'll cover how to wire the Nokia LCD to your CircuitPython microcontroller board. First assemble your LCD.

We're going to show you how to wire it up to a Feather M4 Express. Because the logic levels on a Feather M4 Express are already 3.3v, you don't need a logic level shifter.

Connect the LCD to your microcontroller board as shown below.

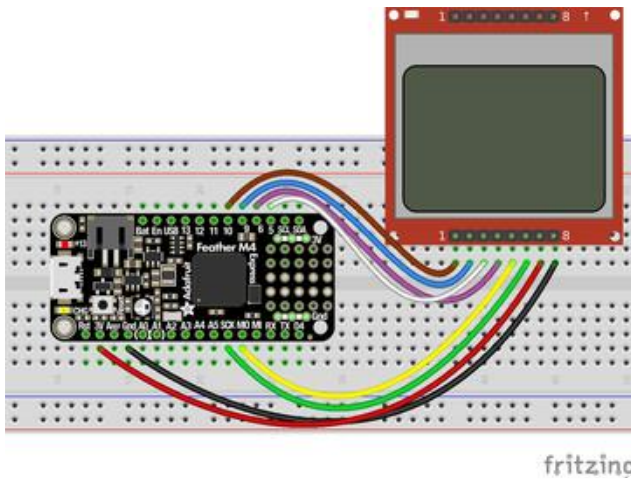

- Microcontroller GND to LCD Gnd
- Microcontroller 3V to LCD Vcc
- Microcontroller SCK to LCD Clk
- Microcontroller MOSI to LCD Din
- Microcontroller D6 to LCD D/C
- Microcontroller D5 to LCD CS
- Microcontroller D9 to LCD Rst
- Microcontroller D10 to LCD Led

[Download the Fritzing Diagram](#)

CircuitPython Setup

CircuitPython Installation of PCD8544 Library

To use the Nokia 5110/3310 LCD with your Adafruit CircuitPython board you'll need to install the [Adafruit CircuitPython PCD8544 \(\)](#) module on your board.

First make sure you are running the [latest version of Adafruit CircuitPython \(\)](#) for your board.

Next you'll need to install the necessary libraries to use the hardware--carefully follow the steps to find and install these libraries from [Adafruit's CircuitPython library bundle \(\)](#). Our CircuitPython starter guide has [a great page on how to install the library bundle \(\)](#).

If you choose, you can manually install the libraries individually on your board:

- adafruit_pcd8544
- adafruit_framebuf
- adafruit_bus_device

Before continuing make sure your board's lib folder or root filesystem has the adafruit_pcd8544.mpy, adafruit_framebuf.mpy and adafruit_bus_device files and folders copied over.

Next [connect to the board's serial REPL \(\)](#) so you are at the CircuitPython >>> prompt.

CircuitPython Usage

It's easy to use the Nokia 5110/3310 LCD with CircuitPython and the [Adafruit CircuitPython PCD8544 \(\)](#) module. This module allows you to easily write Python code to control the display.

You can use this display with any CircuitPython microcontroller board.

To demonstrate the usage, we'll initialize the library and use Python code to control the LCD from the board's Python REPL.

Initialization

First need to initialize the SPI bus. To do that, run the following commands:

```
import adafruit_pcd8544
import board
import busio
import digitalio

spi = busio.SPI(board.SCK, MOSI=board.MOSI)
dc = digitalio.DigitalInOut(board.D6) # data/command
cs = digitalio.DigitalInOut(board.D5) # Chip select
reset = digitalio.DigitalInOut(board.D9) # reset

display = adafruit_pcd8544.PCD8544(spi, dc, cs, reset)
```

The last three parameters to the initializer are the pins connected to the display's DC, CS, and reset lines in that order. Again make sure to use the right pin names as you have wired up to your board!

Controlling the Backlight LED

You can control the display backlight LED as well. Just be sure the LED line is wired up to your microcontroller. Just start by initializing it as a `DigitalInOut` output line. If you wired it to a different output, be sure to change the port accordingly.

```
backlight = digitalio.DigitalInOut(board.D10) # backlight
backlight.switch_to_output()
```

To turn it on, just set it to `True` and to turn it off, just set it to `False`.

```
# Turn Backlight on
backlight.value = True

#Turn Backlight off
backlight.value = False
```

Contrast and Bias

Two important settings so that you can see what is on the display are the contrast and Bias Settings. Let's start by taking a look at the Bias Setting.

Bias

The Bias setting controls the amount of voltage that goes to the display. The higher the value, the darker the display will be. It's kind of like the brightness setting on a monitor, but will make the pixels more intense. A value of 4-5 is usually pretty good. For example, to set it to 5, you would type:

```
display.bias = 5
```

Contrast

The contrast setting controls the difference between the dark and light pixels and can be set to anywhere between 0-127. This is like the contrast setting on a monitor. Too high of a value will make everything appear dark and too low of a value will make everything appear too light. A value of around 50-60 seems to look good. For example, to set it to 50, you would type:

```
display.contrast = 50
```

You may want to play around with different combinations of these values to see what makes your particular display the most readable.

Drawing

The PCD8544 module currently supports a basic set of commands to draw on the display. You can set individual pixels, fill the screen, and write lines of text.

To fill or clear the entire screen use the `fill` function. This function takes a parameter which specifies the color to fill with, either `0` for white or `1` for black. For example to fill the screen black:

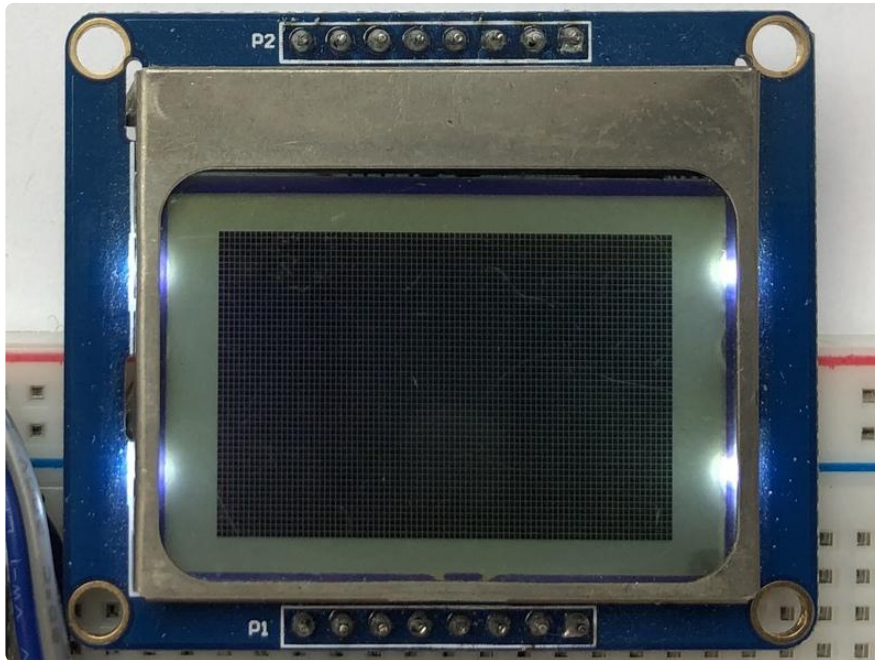

```
display.fill(1)
display.show()
```



Notice the `fill` function doesn't actually change the display. You must call `show` after making drawing commands to send the updated pixel data to the display!

To clear the screen to white just call `fill` again but with the color `0`:

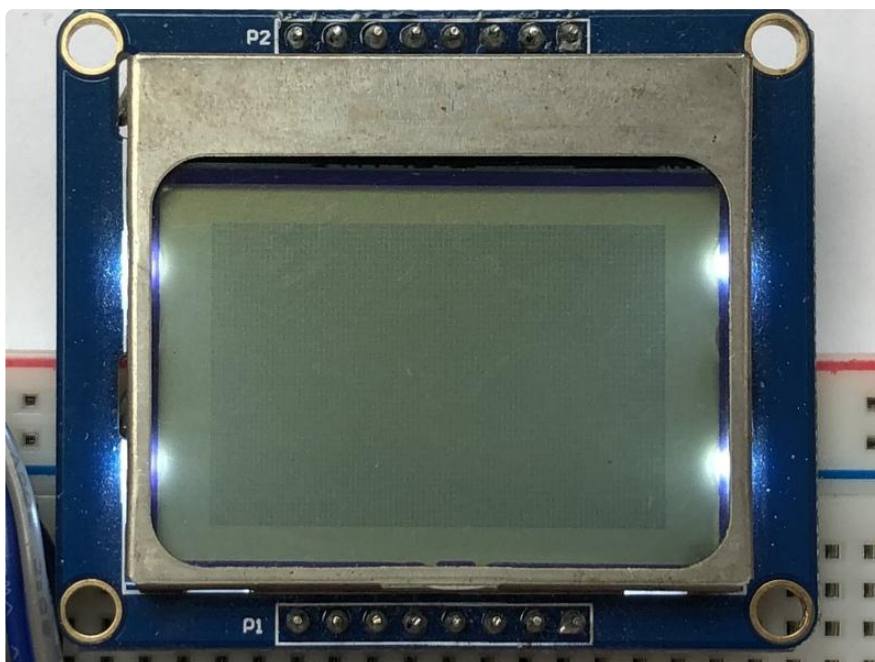
```
display.fill(0)
display.show()
```



To set a pixel use the `pixel` function. This function takes the following parameters:

- Pixel X position
- Pixel Y position
- Pixel color (`0` = white, `1` = black)

For example to set the first pixel black:

```
display.pixel(0, 0, 1)
display.show()
```

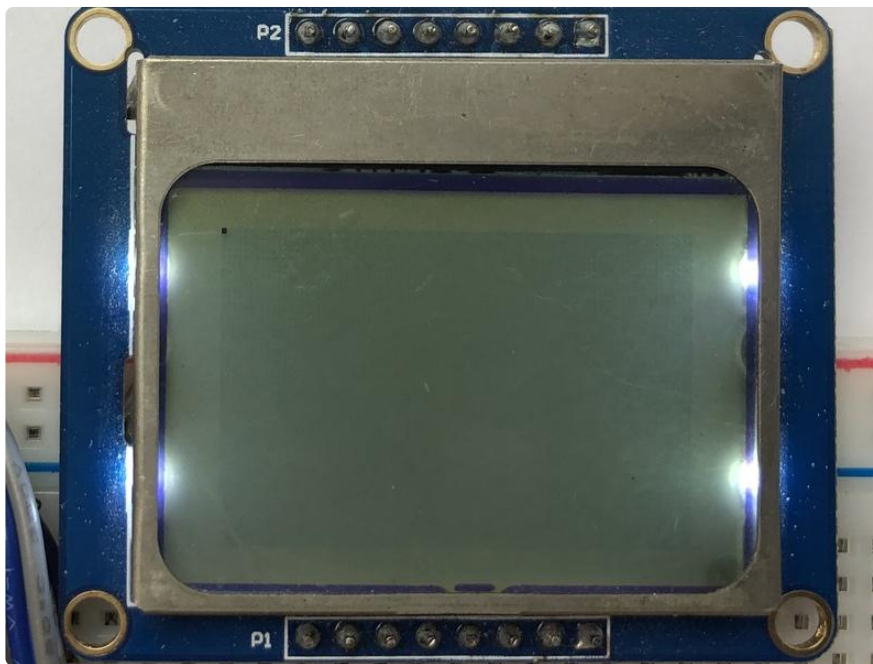

Try setting other pixels white by changing the X and Y position. Remember you have to call `show ()` after setting pixels to see them appear!

Text

To write text to your display, you must download a font file and copy it to your CIRCUITPY drive. Click the button below to download the file, and then copy font5x8.bin to your CIRCUITPY drive.

[Download the font5x8.bin file](#)

You can write a line of text with the `text` function. This function takes the following parameters:

- String of text
- Text X position
- Text Y position
- Text color (`0` = white, `1` = black)

For example to clear the screen and then write two lines of text:

```
display.fill(0)
display.text('Hello', 0, 0, 1)
display.text('World', 0, 10, 1)
display.show()
```

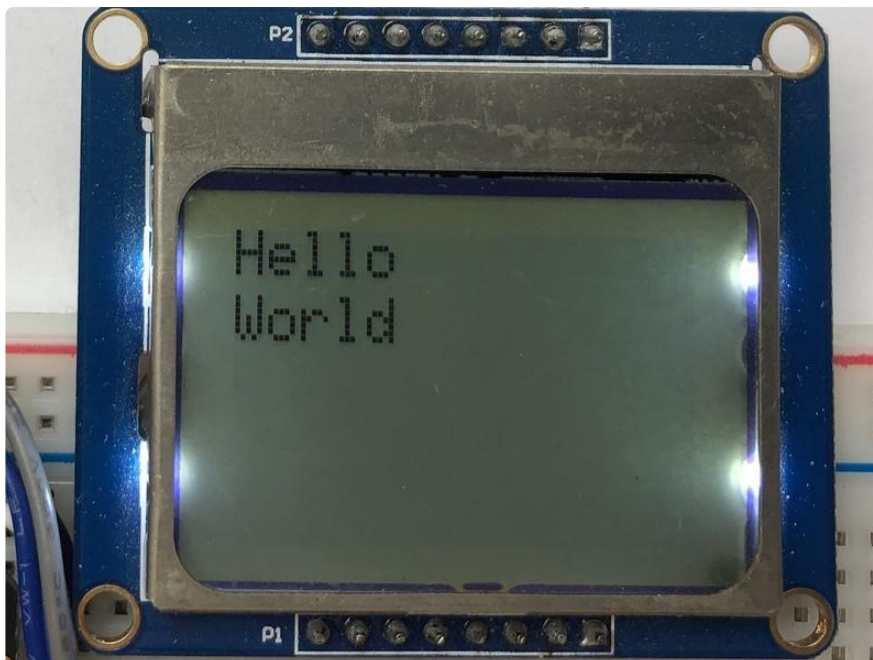

Notice the second line of text starts at Y position `10`, this moves it down the display 10 pixels so it's below the first line of text. The font used by the text function is 8 pixels tall so a size of `10` gives a bit of room between the lines.

Invert

Finally you can invert the display colors with the `invert` property:

```
display.invert = True
```



Note that the `invert` function doesn't need to have `show` called after it to see the change.

To go back to a non-inverted display run:

```
display.invert = False
```

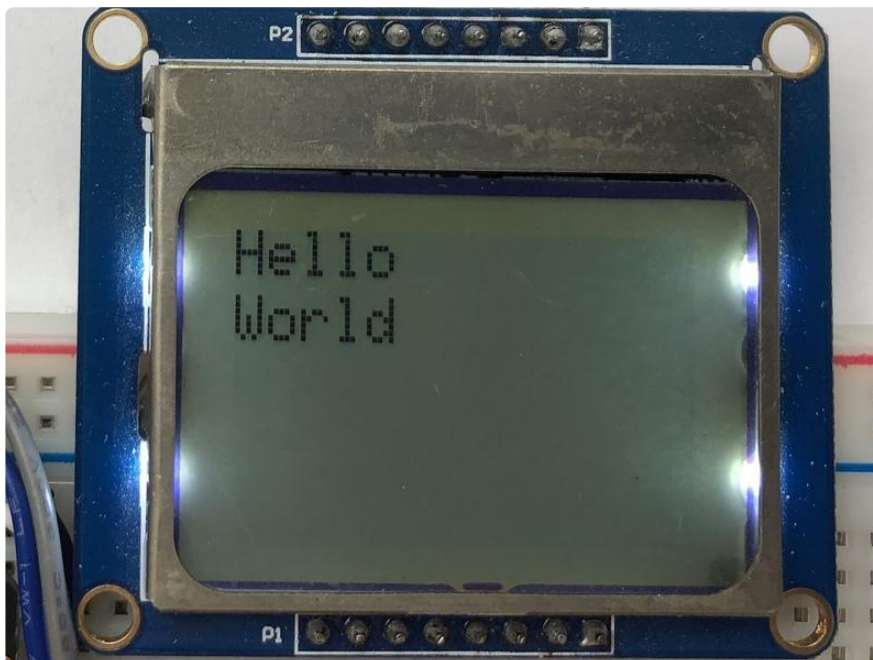

That's all there is to drawing on the Nokia 5110/3310 LCD display with CircuitPython! The drawing functions are basic but provide building blocks for more advanced usage. For example you can display text with sensor readings or other state, or even program a simple game like pong!

Full Example Code

```
# SPDX-FileCopyrightText: 2021 ladyada for Adafruit Industries
# SPDX-License-Identifier: MIT

import time
import board
import busio
import digitalio

import adafruit_pcd8544

# Initialize SPI bus and control pins
spi = busio.SPI(board.SCK, MOSI=board.MOSI)
dc = digitalio.DigitalInOut(board.D6) # data/command
cs = digitalio.DigitalInOut(board.D5) # Chip select
reset = digitalio.DigitalInOut(board.D9) # reset

display = adafruit_pcd8544.PCD8544(spi, dc, cs, reset)

display.bias = 4
display.contrast = 60

# Turn on the Backlight LED
backlight = digitalio.DigitalInOut(board.D10) # backlight
backlight.switch_to_output()
backlight.value = True

print("Pixel test")
# Clear the display. Always call show after changing pixels to make the display
# update visible!
display.fill(0)
display.show()

# Set a pixel in the origin 0,0 position.
display.pixel(0, 0, 1)
# Set a pixel in the middle position.
display.pixel(display.width // 2, display.height // 2, 1)
# Set a pixel in the opposite corner position.
display.pixel(display.width - 1, display.height - 1, 1)
display.show()
time.sleep(2)

print("Lines test")
# we'll draw from corner to corner, lets define all the pair coordinates here
corners = (
    (0, 0),
    (0, display.height - 1),
    (display.width - 1, 0),
    (display.width - 1, display.height - 1),
)

display.fill(0)
for corner_from in corners:
    for corner_to in corners:
        display.line(corner_from[0], corner_from[1], corner_to[0], corner_to[1], 1)
display.show()
time.sleep(2)

print("Rectangle test")
display.fill(0)
w_delta = display.width / 10
h_delta = display.height / 10
for i in range(11):
    display.rect(0, 0, int(w_delta * i), int(h_delta * i), 1)
```

```

display.show()
time.sleep(2)

print("Text test")
display.fill(0)
display.text("hello world", 0, 0, 1)
display.text("this is the", 0, 8, 1)
display.text("CircuitPython", 0, 16, 1)
display.text("adafruit lib-", 0, 24, 1)
display.text("rary for the", 0, 32, 1)
display.text("PCD8544! :) ", 0, 40, 1)

display.show()

while True:
    display.invert = True
    time.sleep(0.5)
    display.invert = False
    time.sleep(0.5)

```

Python Wiring

It's easy to use the Nokia 5110/3310 LCD with Python and the [Adafruit CircuitPython PCD8544 \(\)](#) module. This module allows you to easily write Python code to control the display.

We'll cover how to wire the Nokia LCD to your Raspberry Pi. First assemble your LCD.

Since there's dozens of Linux computers/boards you can use we will show wiring for Raspberry Pi. For other platforms, [please visit the guide for CircuitPython on Linux to see whether your platform is supported \(\)](#).

Connect the LCD as shown below to your Raspberry Pi.

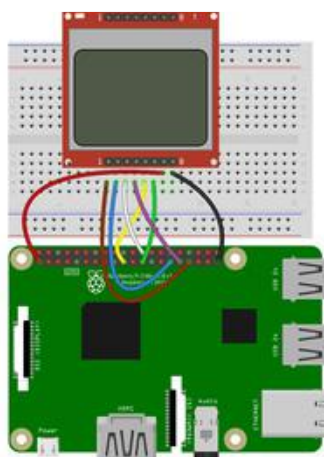

fritzing

- Raspberry Pi GND to LCD Gnd
- Raspberry Pi 3.3V to LCD Vcc
- Raspberry Pi SCK (GPIO 11) to LCD Clk
- Raspberry Pi MOSI (GPIO 10) to LCD Din
- Raspberry Pi GPIO 6 to LCD D/C
- Raspberry Pi CE0 (GPIO 8) to LCD CS
- Raspberry Pi GPIO 5 to LCD Rst
- Raspberry Pi GPIO 13 to LCD Led

[Download the Fritzing Diagram](#)

Python Setup

You'll need to install the Adafruit_Blinka library that provides the CircuitPython support in Python. This may also require enabling SPI on your platform and verifying you are running Python 3. [Since each platform is a little different, and Linux changes often, please visit the CircuitPython on Linux guide to get your computer ready \(!\)](#)

Python Installation of PCD8544 Library

Once that's done, from your command line run the following command:

- `pip3 install adafruit-circuitpython-pcd8544`

If your default Python is version 3 you may need to run 'pip' instead. Just make sure you aren't trying to use CircuitPython on Python 2.x, it isn't supported!

If that complains about pip3 not being installed, then run this first to install it:

- `sudo apt-get install python3-pip`

DejaVu TTF Font

Raspberry Pi usually comes with the DejaVu font already installed, but in case it didn't, you can run the following to install it:

- `sudo apt-get install fonts-dejavu`

This package was previously calls ttf-dejavu, so if you are running an older version of Raspberry Pi OS, it may be called that.

Pillow Library

We also need PIL, the Python Imaging Library, to allow using text with custom fonts. There are several system libraries that PIL relies on, so installing via a package manager is the easiest way to bring in everything:

- `sudo apt-get install python3-pil`

That's it. You should be ready to go.

Python Usage

It's easy to use the Nokia 5110/3310 LCD with CircuitPython and the [Adafruit CircuitPython PCD8544 \(\)](#) module. This module allows you to easily write Python code to control the display.

You can use this display with a computer that has GPIO and Python [thanks to Adafruit_Blinka, our CircuitPython-for-Python compatibility library \(\)](#).

To demonstrate the usage, we'll initialize the library and use Python code to control the LCD from the board's Python REPL.

Since we are running full CPython on our Linux/computer, we can take advantage of the powerful Pillow image drawing library to handle text, shapes, graphics, etc. [Pillow is a gold standard in image and graphics handling, you can read about all it can do here \(\)](#).

Initialization

First need to initialize the SPI bus. To do that, run the following commands:

```
import adafruit_pcd8544
import board
import busio
import digitalio

spi = busio.SPI(board.SCK, MOSI=board.MOSI)
dc = digitalio.DigitalInOut(board.D6) # data/command
cs = digitalio.DigitalInOut(board.CE0) # Chip select
reset = digitalio.DigitalInOut(board.D5) # reset

display = adafruit_pcd8544.PCD8544(spi, dc, cs, reset)
```

The last three parameters to the initializer are the pins connected to the display's DC, CS, and reset lines in that order. Again make sure to use the right pin names as you have wired up to your board!

Controlling the Backlight LED

You can control the display backlight LED as well. Just be sure the LED line is wired up to your microcontroller. Just start by initializing it as a `DigitalInOut` output line. If you wired it to a different output, be sure to change the port accordingly.

```
backlight = digitalio.DigitalInOut(board.D13) # backlight
backlight.switch_to_output()
```

To turn it on, just set it to `True` and to turn it off, just set it to `False`.

```
# Turn Backlight on
backlight.value = True

#Turn Backlight off
backlight.value = False
```

Contrast and Bias

Two important settings so that you can see what is on the display are the contrast and Bias Settings. Let's start by taking a look at the Bias Setting.

Bias

The Bias setting controls the amount of voltage that goes to the display. The higher the value, the darker the display will be. It's kind of like the brightness setting on a monitor, but will make the pixels more intense. A value of 4-5 is usually pretty good. For example, to set it to 5, you would type:

```
display.bias = 5
```

Contrast

The contrast setting controls the difference between the dark and light pixels and can be set to anywhere between 0-127. This is like the contrast setting on a monitor. Too high of a value will make everything appear dark and too low of a value will make everything appear too light. A value of around 50-60 seems to look good. For example, to set it to 50, you would type:

```
display.contrast = 50
```

You may want to play around with different combinations of these values to see what makes your particular display the most readable.

Example Code

```
# SPDX-FileCopyrightText: 2021 ladyada for Adafruit Industries
# SPDX-License-Identifier: MIT
```

```

"""
This demo will fill the screen with white, draw a black box on top
and then print Hello World! in the center of the display

This example is for use on (Linux) computers that are using CPython with
Adafruit Blinka to support CircuitPython libraries. CircuitPython does
not support PIL/pillow (python imaging library)!
"""

import board
import busio
import digitalio
from PIL import Image, ImageDraw, ImageFont
import adafruit_pcd8544

# Parameters to Change
BORDER = 5
FONTSIZE = 10

spi = busio.SPI(board.SCK, MOSI=board.MOSI)
dc = digitalio.DigitalInOut(board.D6) # data/command
cs = digitalio.DigitalInOut(board.CE0) # Chip select
reset = digitalio.DigitalInOut(board.D5) # reset

display = adafruit_pcd8544.PCD8544(spi, dc, cs, reset)

# Contrast and Brightness Settings
display.bias = 4
display.contrast = 60

# Turn on the Backlight LED
backlight = digitalio.DigitalInOut(board.D13) # backlight
backlight.switch_to_output()
backlight.value = True

# Clear display.
display.fill(0)
display.show()

# Create blank image for drawing.
# Make sure to create image with mode '1' for 1-bit color.
image = Image.new("1", (display.width, display.height))

# Get drawing object to draw on image.
draw = ImageDraw.Draw(image)

# Draw a black background
draw.rectangle((0, 0, display.width, display.height), outline=255, fill=255)

# Draw a smaller inner rectangle
draw.rectangle(
    (BORDER, BORDER, display.width - BORDER - 1, display.height - BORDER - 1),
    outline=0,
    fill=0,
)

# Load a TTF font.
font = ImageFont.truetype("/usr/share/fonts/truetype/dejavu/DejaVuSans.ttf",
FONTSIZE)

# Draw Some Text
text = "Hello World!"
(font_width, font_height) = font.getsize(text)
draw.text(
    (display.width // 2 - font_width // 2, display.height // 2 - font_height // 2),
    text,
    font=font,

```

```
        fill=255,
    )
# Display image
display.image(image)
display.show()
```

Let's take a look at the sections of code one by one. We start by importing the `board` so that we can access the pin definitions, `busio` so we can initialize SPI, `digitalio`, several `PIL` modules for Image Drawing, and the `adafruit_pcd8544` driver.

```
import board
import busio
import digitalio
from PIL import Image, ImageDraw, ImageFont
import adafruit_pcd8544
```

In order to make it easy to change display sizes, we'll define a few variables in one spot here. We have the border size and font size, which we will explain a little further below.

```
BORDER = 5
FONTSIZE = 10
```

Next we set the SPI object to the board's SPI with `busio.SPI()`. We also define some Pins that will be used for the display and initialize the display. See the initialization section above for more details.

```
spi = busio.SPI(board.SCK, MOSI=board.MOSI)
dc = digitalio.DigitalInOut(board.D6) # data/command
cs = digitalio.DigitalInOut(board.CE0) # Chip select
reset = digitalio.DigitalInOut(board.D5) # reset

display = adafruit_pcd8544.PCD8544(spi, dc, cs, reset)
```

Next we set the Bias and Contrast. See the Contrast and Bias section for more details.

```
# Contrast and Brightness Settings
display.bias = 4
display.contrast = 60
```

After that we setup the backlight. See the Backlight section above for more information.

```
# Turn on the Backlight LED
backlight = digitalio.DigitalInOut(board.D13) # backlight
backlight.switch_to_output()
backlight.value = True
```

Next we clear the display in case it was initialized with any random artifact data.

```
# Clear display.  
display.fill(0)  
display.show()
```

Next, we need to initialize PIL to create a blank image to draw on. Think of it as a virtual canvas. Since this is a monochrome display, we set it up for 1-bit color, meaning a pixel is either white or black. We can make use of the LCD's width and height properties as well.

```
# Create blank image for drawing.  
# Make sure to create image with mode '1' for 1-bit color.  
image = Image.new('1', (display.width, display.height))  
  
# Get drawing object to draw on image.  
draw = ImageDraw.Draw(image)
```

Now we start the actual drawing. Here we are telling it we want to draw a rectangle from `(0,0)`, which is the upper left, to the full width and height of the display. We want it both filled in and having an outline of black, so we pass 255 for both numbers, which represents the amount of fill.

```
# Draw a black background  
draw.rectangle((0, 0, display.width, display.height), outline=255, fill=255)
```

If we ran the code now, it would still show a blank display because we haven't told python to use our virtual canvas yet. You can skip to the end if you would like to see how to do that. This is what our canvas currently looks like in memory.

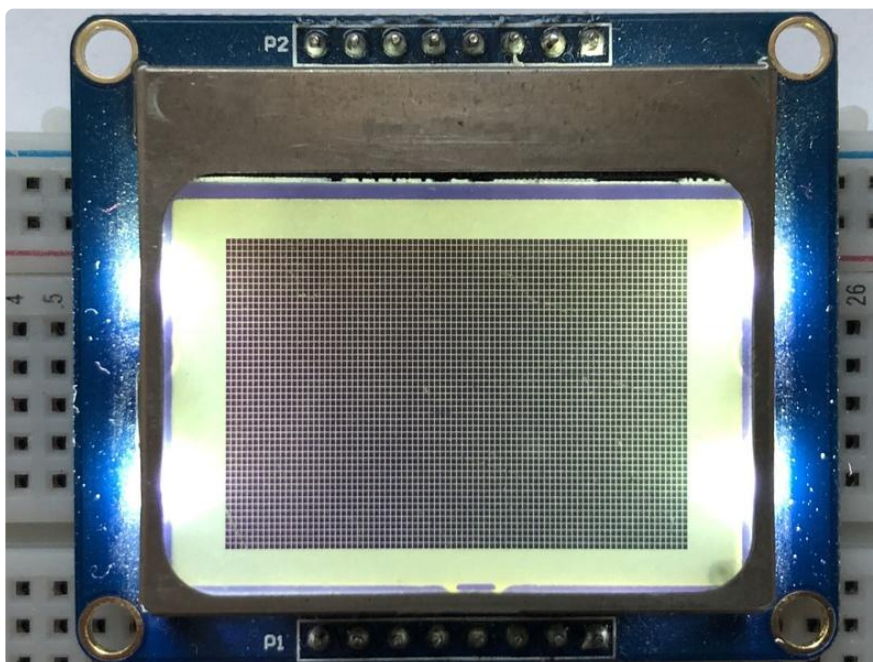

Next we will create a smaller white rectangle. The easiest way to do this is to draw another rectangle a little smaller than the full screen with no fill or outline and place it in a specific location. In this case, we will create a rectangle that is 5 pixels smaller on each side. This is where the BORDER variable comes into use. It makes calculating the size of the second rectangle much easier. We want the starting coordinate, which consists of the first two parameters, to be our BORDER value. Then for the next two parameters, which are our ending coordinates, we want to subtract our border value from the width and height. Also, because this is a zero-based coordinate system, we also need to subtract 1 from each number.

```
# Draw a smaller inner rectangle
draw.rectangle((BORDER, BORDER, display.width - BORDER - 1, display.height - BORDER - 1),
               outline=0, fill=0)
```

Here's what our virtual canvas looks like in memory.

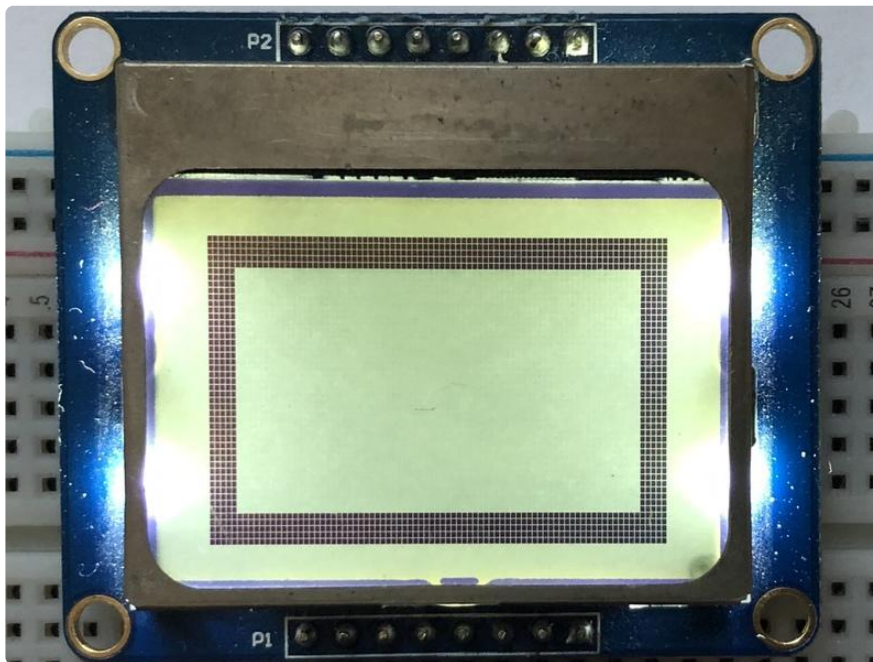

Now drawing text with PIL is pretty straightforward. First we start by setting the font to the default system text. After that we define our text and get the size of the text. We're grabbing the size that it would render at so that we can calculate the center position. Finally, we take the font size and screen size to calculate the position we want to draw the text at and it appears in the center of the screen.

```
# Load a TTF font.
font = ImageFont.truetype('/usr/share/fonts/truetype/dejavu/DejaVuSans.ttf',
                           FONTSIZE)

# Draw Some Text
text = "Hello World!"
(font_width, font_height) = font.getsize(text)
```

```
draw.text((display.width//2 - font_width//2, display.height//2 - font_height//2),
          text, font=font, fill=255)
```

Finally, we need to display our virtual canvas to the LCD and we do that with 2 commands. First we set the image to the screen, then we tell it to show the image.

```
# Display image
display.image(image)
display.show()
```

Don't forget you **MUST** call `display.image(image)` and `display.show()` to actually display the graphics. The LCD takes a while to draw so cluster all your drawing functions into the buffer (fast) and then display them once to the LCD (slow)

Here's what the final output should look like.



Downloads

[Our PCD8544 \(Nokia 5110\) LCD display Arduino library is on github \(\)](#) which comes with example code. This library uses 1/2 Kbytes of RAM since it needs to buffer the entire display but its very fast! The code is simple to adapt to any other microcontroller.

[You'll also need to get the Adafruit GFX Graphics core library which can print text, bitmaps, pixels, rectangles, circles and lines, also available on github \(\)](#).

[The PCD8544 datasheet tells you all about what the display can do \(\)](#).