

NMLU1210

Full Bridge Rectifier

Dual 20 V N-Channel with dual 3.2 A Schottky Barrier Diode, 4.0 x 4.0 x 0.5 mm μ Cool™ Package

Features

- Full-Bridge Rectifier Block
- Up to 3.2 A operation
- Low $R_{DS(on)}$ MOSFET to minimize conduction loss
- Low gate charge MOSFET
- Low V_F Schottky diode
- Ultra Low Inductance Package
- This Device uses Halogen-Free Molding Compound
- These are Pb-Free Devices

Applications

- Wireless Charging
- AC-DC Rectification
- Optimized for Power Management Applications for Portable Products, such as Cell Phones, PMP, DSC, GPS, and others

RECTIFIER MAXIMUM RATINGS ($T_J = 25^\circ\text{C}$ unless otherwise stated)

Parameter	Symbol	Value	Unit	
Input voltage between two MOSFET drain	V_{LL}	20	V	
Bridge Operating Junction and Storage Temperature	T_J, T_{STG}	-55 to 125	$^\circ\text{C}$	
Lead Temperature for Soldering Purposes (1/8" from case for 10 s)	T_L	260	$^\circ\text{C}$	
Continuous Drain Current R_{JA} (Note 1)	I_O	$T_A = 25^\circ\text{C}$	2.2	A
		$T_A = 85^\circ\text{C}$	1.16	
Power Dissipation R_{JA} (Note 1)	P_D	$T_A = 25^\circ\text{C}$	1.2	W
		$T_A = 85^\circ\text{C}$	0.47	
Continuous Drain Current $R_{JA} t < 5$ s (Note 1)	I_O	$T_A = 25^\circ\text{C}$	3.2	A
		$T_A = 85^\circ\text{C}$	1.88	
Power Dissipation $R_{JA} t < 5$ s (Note 1)	P_D	$T_A = 25^\circ\text{C}$	2.34	W
		$T_A = 85^\circ\text{C}$	0.94	
Continuous Drain Current R_{JA} (Note 2)	I_O	$T_A = 25^\circ\text{C}$	1.16	A
		$T_A = 85^\circ\text{C}$	0.6	
Power Dissipation R_{JA} (Note 2)	P_D	$T_A = 25^\circ\text{C}$	0.47	W
		$T_A = 85^\circ\text{C}$	0.185	

Stresses exceeding Maximum Ratings may damage the device. Maximum Ratings are stress ratings only. Functional operation above the Recommended Operating Conditions is not implied. Extended exposure to stresses above the Recommended Operating Conditions may affect device reliability.

1. Surface-mounted on FR4 board using 1 in sq pad size (Cu area = 1.127 in sq [2 oz] including traces).
2. Surface-mounted on FR4 board using the minimum recommended pad size of 30 mm², 2 oz. Cu.



ON Semiconductor®

<http://onsemi.com>

MOSFET

$V_{(BR)DSS}$	$R_{DS(on)}$ TYP	I_D MAX
20 V	23 m Ω @ 4.5 V	3.2 A
	17 m Ω @ 10 V	

SCHOTTKY DIODE

V_R MAX	V_F TYP	I_F MAX
20 V	0.45 V	3.2 A

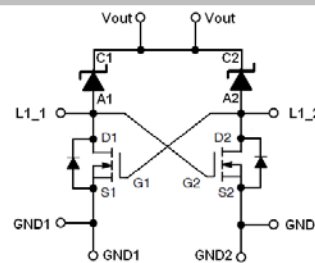

RECTIFIER

4.0 4.0 mm μ Cool Pin Connections (Top View)

MARKING DIAGRAM



1210 = Specific Device Code
 A = Assembly Location
 Y = Year
 WW = Work Week
 ■ = Pb-Free Package

(*Note: Microdot may be in either location)

PIN CONNECTIONS

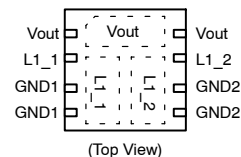

ORDERING INFORMATION

Device	Package	Shipping†
NMLU1210TWG	UDFN (Pb-Free)	3000 / Tape & Reel

†For information on tape and reel specifications, including part orientation and tape sizes, please refer to our Tape and Reel Packaging Specifications Brochure, BRD8011/D.

NMLU1210

THERMAL RESISTANCE RATINGS

Parameter	Symbol	Max	Unit
Junction-to-Ambient – Steady State (Note 3)	$R_{\theta JA}$	82.5	°C/W
Junction-to-Ambient – $t \leq 5$ s (Note 3)	$R_{\theta JA}$	42.5	
Junction-to-Ambient – Steady State min Pad (Note 4)	$R_{\theta JA}$	209	

3. Surface-mounted on FR4 board using 1 in sq pad size (Cu area = 1.127 in sq [2 oz] including traces).
 4. Surface-mounted on FR4 board using the minimum recommended pad size of 30 mm², 2 oz. Cu.

BRIDGE ELECTRICAL CHARACTERISTICS ($T_J = 25^\circ\text{C}$ unless otherwise specified)

Parameter	Symbol	Test Condition	Min	Typ	Max	Unit
ON CHARACTERISTICS						
Rectifying Forward Voltage (Note 5)	V_{fd2}	Input voltage $V_{LL} = \pm 5$ V; The output current of Rectifier $I_{out} = 2$ A		0.45	.56	V
Rectifier leakage current	I_{leak}	Input voltage $V_{LL} = 16$ V; No Load on the Rectifier output		31	1000	uA
Rectifier Reverse leakage current	I_{rleak}	Input voltage $V_{LL} = 0$ V; The output voltage of the Rectifier $V_{out} = 5$ V		21	1000	uA

5. Pulse Test: pulse width ≤ 300 μs , duty cycle $\leq 2\%$

MOSFET ELECTRICAL CHARACTERISTICS ($T_J = 25^\circ\text{C}$ unless otherwise specified)

Parameter	Symbol	Test Condition	Min	Typ	Max	Unit
ON CHARACTERISTICS						
Gate Threshold Voltage	$V_{GS(TH)}$	$V_{GS} = V_{DS}$, $I_D = 250$ μA	1.2		2.2	V
Negative Threshold Temperature Coefficient	$V_{GS(TH)} / T_J$			4		mV/°C
Drain-to-Source On Resistance (Note 6)	$R_{DS(on)}$	$V_{GS} = 10$ V, $I_D = 3.2$ A		17	26	m Ω
		$V_{GS} = 4.5$ V, $I_D = 3.2$ A		23	32	
Forward Transconductance	g_{FS}	$V_{DS} = 10$ V, $I_D = 2.0$ A		3.5		S

DRAIN-SOURCE DIODE CHARACTERISTICS

Forward Diode Voltage (Note 6)	V_{SD}	$V_{GS} = 0$ V, $I_S = 2.0$ A	$T_J = 25^\circ\text{C}$		0.79	V
			$T_J = 125^\circ\text{C}$		0.65	

6. Pulse Test: pulse width ≤ 300 μs , duty cycle $\leq 2\%$

SCHOTTKY DIODE ELECTRICAL CHARACTERISTICS ($T_J = 25^\circ\text{C}$ unless otherwise specified)

Parameter	Symbol	Test Condition	Min	Typ	Max	Unit
Maximum Instantaneous Forward Voltage (Note 7)	V_F	$I_F = 1.0$ A		0.36		V
		$I_F = 2.0$ A		0.41		
Maximum Instantaneous Reverse Current	I_R	$V_R = 20$ V		0.04		mA

7. Pulse Test: pulse width ≤ 300 μs , duty cycle $\leq 2\%$

SCHOTTKY DIODE ELECTRICAL CHARACTERISTICS ($T_J = 100^\circ\text{C}$ unless otherwise specified)

Parameter	Symbol	Test Condition	Min	Typ	Max	Unit
Maximum Instantaneous Forward Voltage (Note 8)	V_F	$I_F = 1.0$ A		0.29		V
		$I_F = 2.0$ A		0.36		
Maximum Instantaneous Reverse Current	I_R	$V_R = 20$ V		4		mA

8. Pulse Test: pulse width ≤ 300 μs , duty cycle $\leq 2\%$
 9. For detailed MOSFET and Diode parameters, please refer to the ON Semiconductor datasheets of NTTFS4930N and MBR230LSFT1G. The test on each individual die is limited to the system package.

NMLU1210

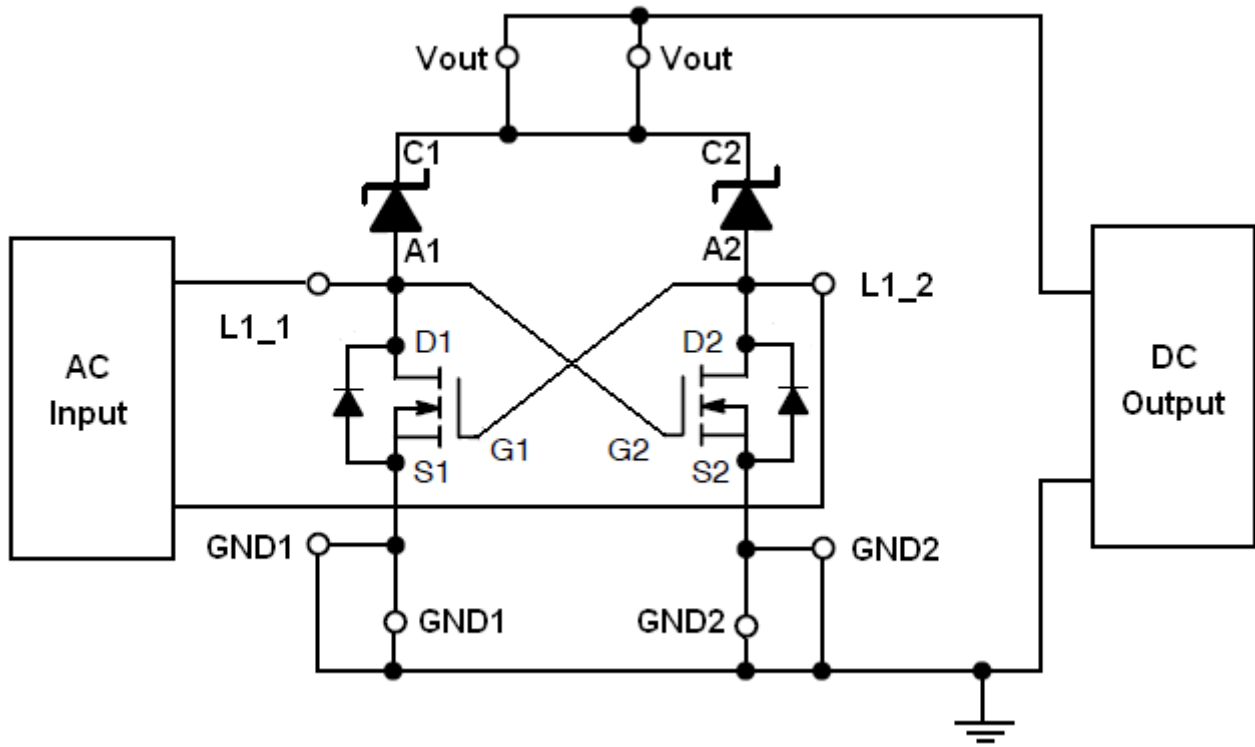

Figure 1. Typical Application Circuit

GND1 and GND2 are not internally connected. The user should make the connection in the PCB design.

TYPICAL PERFORMANCE CURVES

($T_J = 25^\circ\text{C}$ unless otherwise specified)

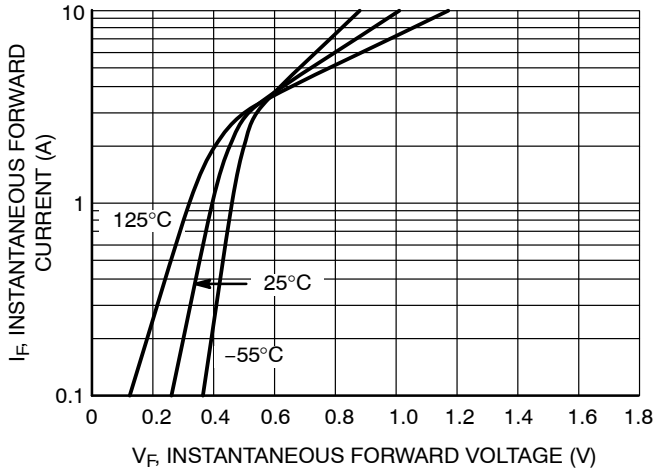

Figure 2. Bridge Typical Forward Voltage Drop at $V_{in} \geq 5\text{ V}$

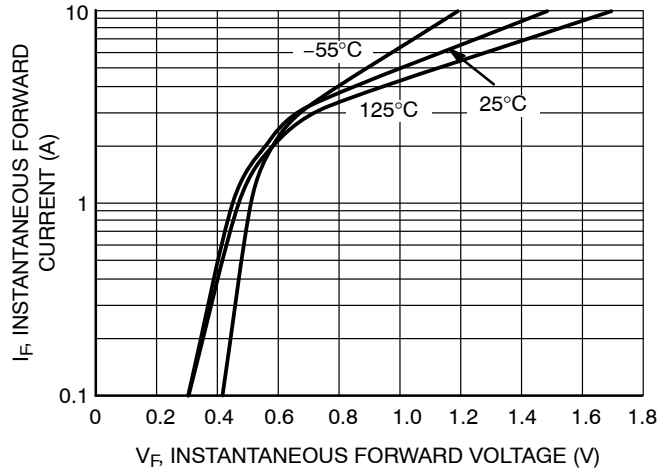

Figure 3. Bridge Maximum Forward Voltage Drop at $V_{in} \geq 5\text{ V}$

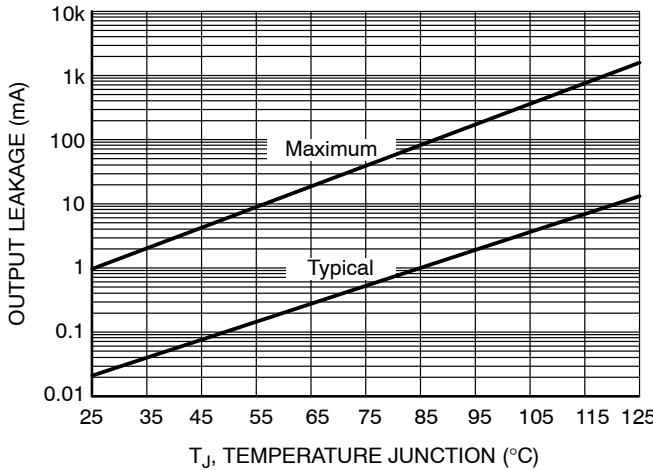

Figure 4. Output Leakage at 5 V Bias vs. Junction Temperature

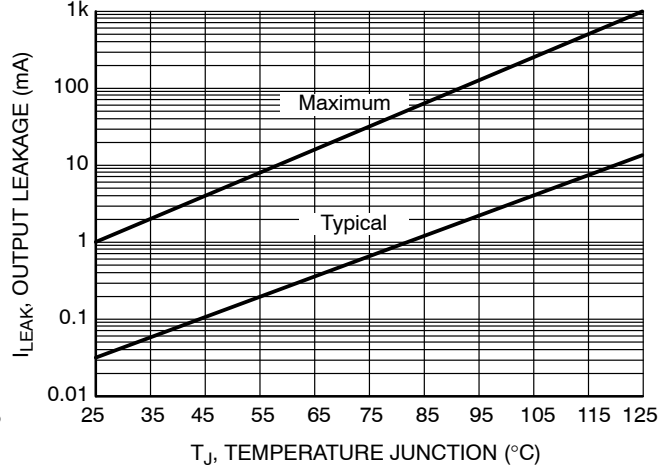

Figure 5. Input Leakage at 16 V vs. Junction Temperature

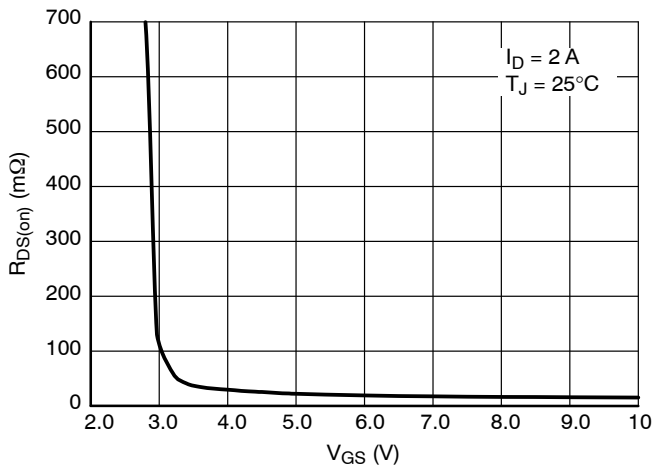

Figure 6. FET Typical On-Resistance vs. Gate-to-Source Voltage (from 3 V to 10 V)

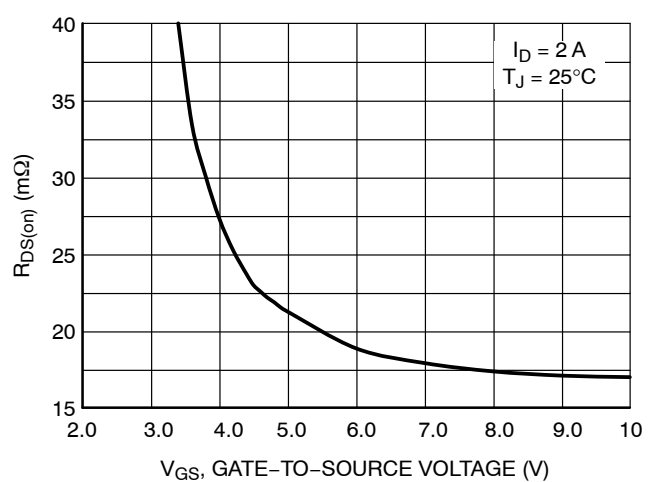

Figure 7. FET Typical On-Resistance vs. Gate-to-Source Voltage

NMLU1210

TYPICAL PERFORMANCE CURVES

($T_J = 25^\circ\text{C}$ unless otherwise specified)

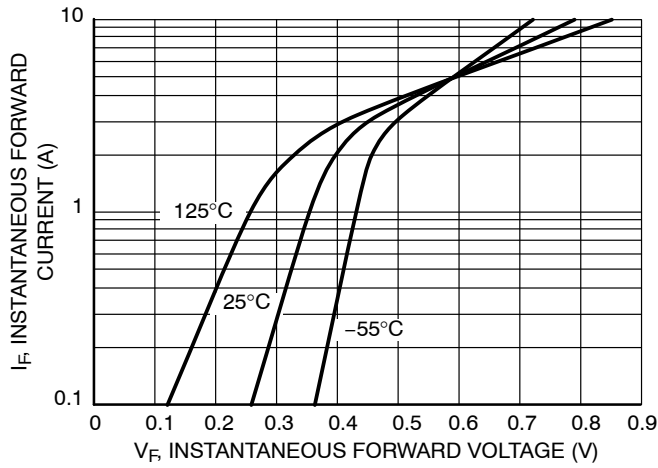

Figure 8. Schottky Typical Forward Current vs. Forward Voltage

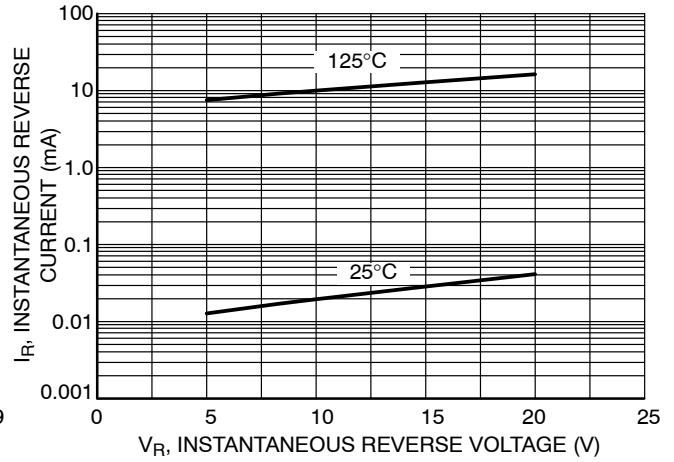

Figure 9. Schottky Typical Reverse Current vs. Reverse Voltage

MECHANICAL CASE OUTLINE

PACKAGE DIMENSIONS

ON Semiconductor®



UDFN8 4x4, 0.8P CASE 517BS ISSUE A

DATE 06 SEP 2011

SCALE 2:1

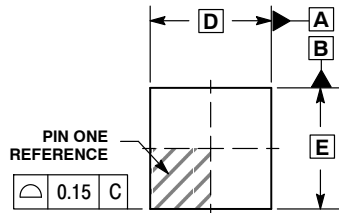

TOP VIEW

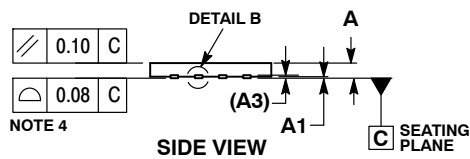

SIDE VIEW

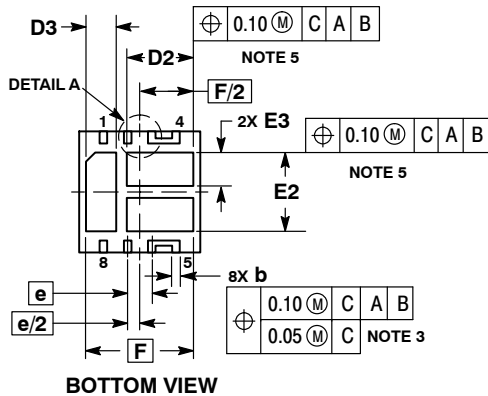

BOTTOM VIEW

RECOMMENDED SOLDERING FOOTPRINT*

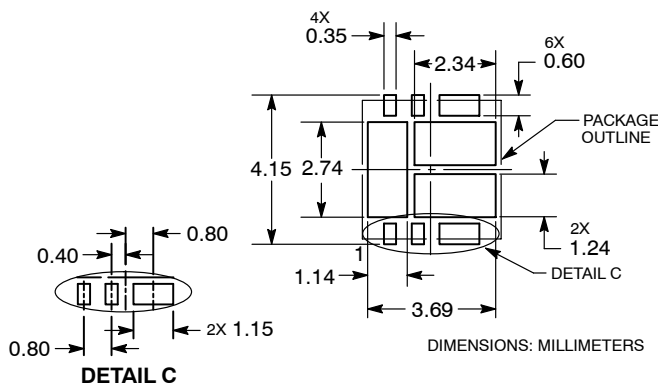

DETAIL C

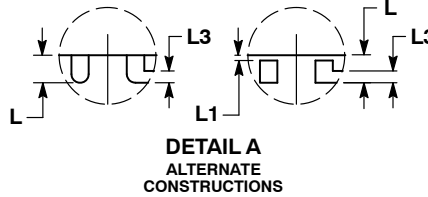

DETAIL A
ALTERNATE
CONSTRUCTIONS

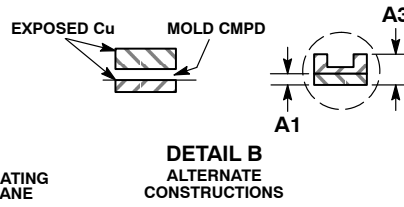

DETAIL B
ALTERNATE
CONSTRUCTIONS

NOTES:

1. DIMENSIONING AND TOLERANCING PER ASME Y14.5M, 1994.
2. CONTROLLING DIMENSION: MILLIMETERS.
3. DIMENSION b APPLIES TO PLATED TERMINAL AND IS MEASURED BETWEEN 0.15 AND 0.25MM FROM TERMINAL TIP.
4. COPLANARITY APPLIES TO THE EXPOSED PAD AS WELL AS THE TERMINALS.
5. POSITIONAL TOLERANCE APPLIES TO ALL OF THE EXPOSED PADS.

MILLIMETERS		
DIM	MIN	MAX
A	0.45	0.55
A1	0.00	0.05
A3	0.13	REF
b	0.20	0.30
D	4.00	BSC
D2	2.10	2.30
D3	0.90	1.10
E	4.00	BSC
E2	2.50	2.70
E3	1.00	1.20
e	0.80	BSC
F	3.55	BSC
L	0.30	0.50
L1	0.00	0.15
L3	0.13	0.23

GENERIC MARKING DIAGRAM*

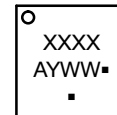

- XXXX = Specific Device Code
- A = Assembly Location
- Y = Year
- WW = Work Week
- = Pb-Free Package

(Note: Microdot may be in either location)

*This information is generic. Please refer to device data sheet for actual part marking. Pb-Free indicator, "G" or microdot "▪", may or may not be present.

*For additional information on our Pb-Free strategy and soldering details, please download the ON Semiconductor Soldering and Mounting Techniques Reference Manual, SOLDERRM/D.

DOCUMENT NUMBER:	98AON53285E	Electronic versions are uncontrolled except when accessed directly from the Document Repository. Printed versions are uncontrolled except when stamped "CONTROLLED COPY" in red.
DESCRIPTION:	UDFN8 4X4, 0.8P	PAGE 1 OF 1

ON Semiconductor and ON are trademarks of Semiconductor Components Industries, LLC dba ON Semiconductor or its subsidiaries in the United States and/or other countries. ON Semiconductor reserves the right to make changes without further notice to any products herein. ON Semiconductor makes no warranty, representation or guarantee regarding the suitability of its products for any particular purpose, nor does ON Semiconductor assume any liability arising out of the application or use of any product or circuit, and specifically disclaims any and all liability, including without limitation special, consequential or incidental damages. ON Semiconductor does not convey any license under its patent rights nor the rights of others.

onsemi, **Onsemi**, and other names, marks, and brands are registered and/or common law trademarks of Semiconductor Components Industries, LLC dba "**onsemi**" or its affiliates and/or subsidiaries in the United States and/or other countries. **onsemi** owns the rights to a number of patents, trademarks, copyrights, trade secrets, and other intellectual property. A listing of **onsemi**'s product/patent coverage may be accessed at www.onsemi.com/site/pdf/Patent-Marking.pdf. **onsemi** reserves the right to make changes at any time to any products or information herein, without notice. The information herein is provided "as-is" and **onsemi** makes no warranty, representation or guarantee regarding the accuracy of the information, product features, availability, functionality, or suitability of its products for any particular purpose, nor does **onsemi** assume any liability arising out of the application or use of any product or circuit, and specifically disclaims any and all liability, including without limitation special, consequential or incidental damages. Buyer is responsible for its products and applications using **onsemi** products, including compliance with all laws, regulations and safety requirements or standards, regardless of any support or applications information provided by **onsemi**. "Typical" parameters which may be provided in **onsemi** data sheets and/or specifications can and do vary in different applications and actual performance may vary over time. All operating parameters, including "Typicals" must be validated for each customer application by customer's technical experts. **onsemi** does not convey any license under any of its intellectual property rights nor the rights of others. **onsemi** products are not designed, intended, or authorized for use as a critical component in life support systems or any FDA Class 3 medical devices or medical devices with a same or similar classification in a foreign jurisdiction or any devices intended for implantation in the human body. Should Buyer purchase or use **onsemi** products for any such unintended or unauthorized application, Buyer shall indemnify and hold **onsemi** and its officers, employees, subsidiaries, affiliates, and distributors harmless against all claims, costs, damages, and expenses, and reasonable attorney fees arising out of, directly or indirectly, any claim of personal injury or death associated with such unintended or unauthorized use, even if such claim alleges that **onsemi** was negligent regarding the design or manufacture of the part. **onsemi** is an Equal Opportunity/Affirmative Action Employer. This literature is subject to all applicable copyright laws and is not for resale in any manner.

ADDITIONAL INFORMATION

TECHNICAL PUBLICATIONS:

Technical Library: www.onsemi.com/design/resources/technical-documentation
onsemi Website: www.onsemi.com

ONLINE SUPPORT: www.onsemi.com/support

For additional information, please contact your local Sales Representative at www.onsemi.com/support/sales