

NLAS4684

Analog Switch, Dual SPDT, Ultra-Low Resistance

The NLAS4684 is an advanced CMOS analog switch fabricated in Sub-micron silicon gate CMOS technology. The device is a dual Independent Single Pole Double Throw (SPDT) switch featuring Ultra-Low R_{ON} of 0.5Ω , for the Normally Closed (NC) switch, and 0.8Ω for the Normally Opened switch (NO) at 2.7 V.

The part also features guaranteed Break Before Make switching, assuring the switches never short the driver.

The NLAS4684 is available in a 2.0 x 1.5 mm bumped die array. The pitch of the solder bumps is 0.5 mm for easy handling.

Features

- Ultra-Low R_{ON} , $< 0.5 \Omega$ at 2.7 V
- Threshold Adjusted to Function with 1.8 V Control at $V_{CC} = 2.7-3.3$ V
- Single Supply Operation from 1.8–5.5 V
- Tiny 2 x 1.5 mm Bumped Die
- Low Crosstalk, < 83 dB at 100 kHz
- Full 0– V_{CC} Signal Handling Capability
- High Isolation, -65 dB at 100 kHz
- Low Standby Current, < 50 nA
- Low Distortion, $< 0.14\%$ THD
- R_{ON} Flatness of 0.15Ω
- Pin for Pin Replacement for MAX4684
- High Continuous Current Capability
 ± 300 mA Through Each Switch
- Large Current Clamping Diodes at Analog Inputs
 ± 300 mA Continuous Current Capability
- Pb-Free Packages are Available

Applications

- Cell Phone
- Speaker Switching
- Power Switching
- Modems
- Automotive



ON Semiconductor®

<http://onsemi.com>

MARKING DIAGRAMS

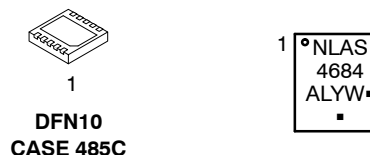
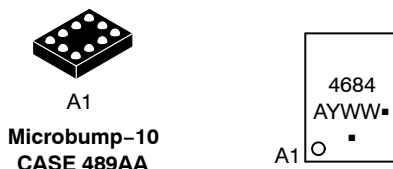

A = Assembly Location
L = Wafer Lot
Y = Year
WW, W = Work Week
▪ = Pb-Free Package

(Note: Microdot may be in either location)

FUNCTION TABLE

IN 1, 2	NO 1, 2	NC 1, 2
0	OFF	ON
1	ON	OFF

ORDERING INFORMATION

See detailed ordering and shipping information in the package dimensions section on page 11 of this data sheet.

NLAS4684

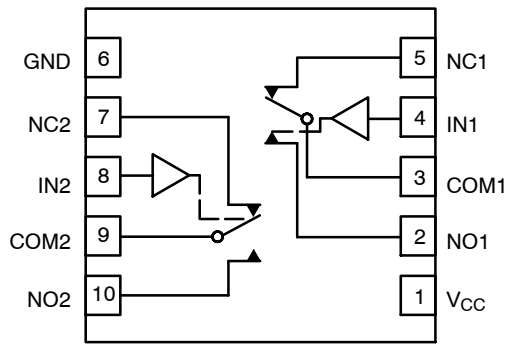

(Top View)

Figure 1. Pin Connections and Logic Diagram (DFN10 and Micro10)

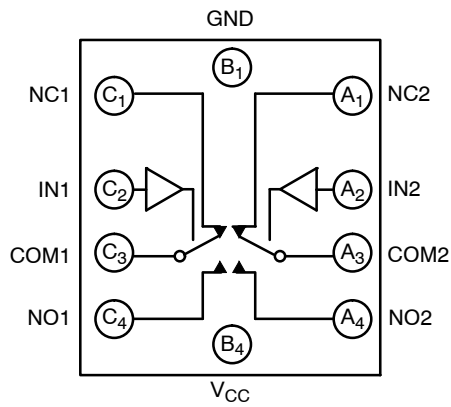

(Top View)

Figure 2. Pin Connections and Logic Diagram (Microbump-10)

MAXIMUM RATINGS

Symbol	Parameter	Value	Unit
V _{CC}	Positive DC Supply Voltage	-0.5 to +7.0	V
V _{IS}	Analog Input Voltage (V _{NO} , V _{NC} , or V _{COM})	-0.5 ≤ V _{IS} ≤ V _{CC} + 0.5	V
V _{IN}	Digital Select Input Voltage	-0.5 ≤ V _I ≤ +7.0	V
I _{anl1}	Continuous DC Current from COM to NC/NO	±300	mA
I _{anl-pk 1}	Peak Current from COM to NC/NO, 10 duty cycle (Note 1)	±500	mA
I _{clmp}	Continuous DC Current into COM/NO/NC	±300	mA
I _{clmp 1}	Peak Current into Input Clamp Diodes at COM/NC/NO	±500	mA

Stresses exceeding Maximum Ratings may damage the device. Maximum Ratings are stress ratings only. Functional operation above the Recommended Operating Conditions is not implied. Extended exposure to stresses above the Recommended Operating Conditions may affect device reliability.

1. Defined as 10% ON, 90% off duty cycle.

RECOMMENDED OPERATING CONDITIONS

Symbol	Parameter	Min	Max	Unit
V _{CC}	DC Supply Voltage	1.8	5.5	V
V _{IN}	Digital Select Input Voltage	GND	5.5	V
V _{IS}	Analog Input Voltage (NC, NO, COM)	GND	V _{CC}	V
T _A	Operating Temperature Range	-55	+125	°C
t _r , t _f	Input Rise or Fall Time, SELECT	V _{CC} = 3.3 V ± 0.3 V 0 V _{CC} = 5.0 V ± 0.5 V 0	100 20	ns/V
ESD	Human Body Model – All Pins		5	kV

DC CHARACTERISTICS – Digital Section (Voltages Referenced to GND)

Symbol	Parameter	Condition	V _{CC} ± 10%	Guaranteed Limit			Unit
				-55°C to 25°C	< 85°C	< 125°C	
V _{IH}	Minimum High-Level Input Voltage, Select Inputs (Figure 9)		2.0	1.4	1.4	1.4	V
			2.5	1.4	1.4	1.4	
			3.0	1.4	1.4	1.4	
			5.0	2.0	2.0	2.0	
V _{IL}	Maximum Low-Level Input Voltage, Select Inputs (Figure 9)		2.0	0.5	0.5	0.5	V
			2.5	0.5	0.5	0.5	
			3.0	0.5	0.5	0.5	
			5.0	0.8	0.8	0.8	
I _{IN}	Maximum Input Leakage Current, Select Inputs	V _{IN} = 5.5 V or GND	5.5	± 1.0	± 1.0	± 1.0	µA
I _{OFF}	Power Off Leakage Current	V _{IN} = 5.5 V or GND	0	± 10	± 10	± 10	µA
I _{CC}	Maximum Quiescent Supply Current (Note 2)	Select and V _{IS} = V _{CC} or GND	5.5	± 180	± 200	± 200	nA

2. Guaranteed by design.

NLAS4684

DC ELECTRICAL CHARACTERISTICS – Analog Section

Symbol	Parameter	Condition	$V_{CC} \pm 10\%$	Guaranteed Maximum Limit						Unit
				-55°C to 25°C		< 85°C		< 125°C		
				Min	Max	Min	Max	Min	Max	
R _{ON} (NC)	NC "ON" Resistance (Note 3)	$V_{IN} \leq V_{IL}$ $V_{IS} = \text{GND to } V_{CC}$ $ I_{IN} \leq 100 \text{ mA}$	2.5		0.6		0.7		0.8	Ω
			3.0		0.5		0.5		0.5	
			5.0		0.4		0.4		0.5	
R _{ON} (NO)	NO "ON" Resistance (Note 3)	$V_{IN} \geq V_{IH}$ $V_{IS} = \text{GND to } V_{CC}$ $ I_{IN} \leq 100 \text{ mA}$	2.5		1.0		1.0		1.0	Ω
			3.0		0.8		0.8		1.0	
			5.0		0.8		0.8		0.9	
R _{FLAT} (NC)	NC On-Resistance Flatness (Notes 3, 5)	$I_{COM} = 100 \text{ mA}$ $V_{IS} = 0 \text{ to } V_{CC}$	2.5		0.15		0.15		0.15	Ω
			3.0		0.15		0.15		0.15	
			5.0		0.15		0.15		0.15	
R _{FLAT} (NO)	NO On-Resistance Flatness (Notes 3, 5)	$I_{COM} = 100 \text{ mA}$ $V_{IS} = 0 \text{ to } V_{CC}$	2.5		0.35		0.35		0.35	Ω
			3.0		0.35		0.35		0.35	
			5.0		0.35		0.35		0.35	
ΔR_{ON}	On-Resistance Match Between Channels (Notes 3 and 4)	$V_{IS} = 1.3 \text{ V};$ $I_{COM} = 100 \text{ mA}$ $V_{IS} = 1.5 \text{ V};$ $I_{COM} = 100 \text{ mA}$ $V_{IS} = 2.8 \text{ V};$ $I_{COM} = 100 \text{ mA}$	2.5		0.18		0.18		0.18	Ω
			3.0		0.06		0.06		0.06	
			5.0		0.06		0.06		0.06	
I _{NC(OFF)} I _{NO(OFF)}	NC or NO Off Leakage Current (Figure 13) (Note 3)	$V_{IN} = V_{IL} \text{ or } V_{IH}$ $V_{NO} \text{ or } V_{NC} = 1.0$ $V_{COM} = 4.5 \text{ V}$	5.5	-1	1	-10	10	-100	100	nA
I _{COM(ON)}	COM ON Leakage Current (Figure 13) (Note 3)	$V_{IN} = V_{IL} \text{ or } V_{IH}$ $V_{NO} 1.0 \text{ V or } 4.5 \text{ V with}$ $V_{NC} \text{ floating or}$ $V_{NC} 1.0 \text{ V or } 4.5 \text{ V with}$ $V_{NO} \text{ floating}$ $V_{COM} = 1.0 \text{ V or } 4.5 \text{ V}$	5.5	-2	2	-20	20	-200	200	nA

3. Guaranteed by design. Resistance measurements do not include test circuit or package resistance.

4. $\Delta R_{ON} = R_{ON(MAX)} - R_{ON(MIN)}$ between NC1 and NC2 or between NO1 and NO2.

5. Flatness is defined as the difference between the maximum and minimum value of on-resistance as measured over the specified analog signal ranges.

NLAS4684

AC ELECTRICAL CHARACTERISTICS (Input $t_r = t_f = 3.0$ ns) (Typical characteristics are at 25°C)

Symbol	Parameter	Test Conditions	V _{CC} (V)	V _{IS} (V)	Guaranteed Maximum Limit						Unit	
					-55°C to 25°C			< 85°C		< 125°C		
					Min	Typ	Max	Min	Max	Min		Max
t _{ON}	Turn-On Time	R _L = 50 Ω, C _L = 35 pF (Figures 4 and 5)	2.5	1.3			60		70		70	ns
			3.0	1.5			50		60		60	
			5.0	2.8			30		35		35	
t _{OFF}	Turn-Off Time	R _L = 50 Ω, C _L = 35 pF (Figures 4 and 5)	2.5	1.3			50		55		55	ns
			3.0	1.5			40		50		50	
			5.0	2.8			30		35		35	
t _{BBM}	Minimum Break-Before-Make Time (Note 6)	V _{IS} = 3.0 R _L = 300 Ω, C _L = 35 pF (Figure 3)	3.0	1.5	2	15						ns

		Typical @ 25, V _{CC} = 5.0 V				Unit
C _{NC Off}	NC Off Capacitance, f = 1 MHz	102				
C _{NO Off}	NO Off Capacitance, f = 1 MHz	104				
C _{NC On}	NC On Capacitance, f = 1 MHz	322				
C _{NO On}	NO On Capacitance, f = 1 MHz	330				

ADDITIONAL APPLICATION CHARACTERISTICS (Voltages Referenced to GND Unless Noted)

Symbol	Parameter	Condition	V _{CC} V	Typical	Unit
				25°C	
BW	Maximum On-Channel -3dB Bandwidth or Minimum Frequency Response	V _{IN} = 0 dBm V _{IN} centered between V _{CC} and GND (Figure 6)	NC	6.5	MHz
			NO	9.5	
V _{ONL}	Maximum Feed-through On Loss	V _{IN} = 0 dBm @ 100 kHz to 50 MHz V _{IN} centered between V _{CC} and GND (Figure 6)	3.0	-0.05	dB
V _{ISO}	Off-Channel Isolation (Note 7)	f = 100 kHz; V _{IS} = 1 V RMS; C _L = 5 nF V _{IN} centered between V _{CC} and GND (Figure 6)	3.0	-65	dB
Q	Charge Injection Select Input to Common I/O (Figures 10 and 11)	V _{IN} = V _{CC} to GND, R _{IS} = 0 Ω, C _L = 1 nF Q = C _L - ΔV _{OUT} (Figure 7)	3.0	15	pC
THD	Total Harmonic Distortion THD + Noise (Figure 9)	F _{IS} = 20 Hz to 100 kHz, R _L = R _{gen} = 600 Ω, C _L = 50 pF V _{IS} = 1 V RMS	3.0	0.14	%
VCT	Channel-to-Channel Crosstalk	f = 100 kHz; V _{IS} = 1 V RMS, C _L = 5 pF, R _L = 50 Ω V _{IN} centered between V _{CC} and GND (Figure 6)	3.0	-83	dB

6. -55°C specifications are guaranteed by design.

7. Off-Channel Isolation = 20log10 (Vcom/Vno) (See Figure 6).

NLAS4684

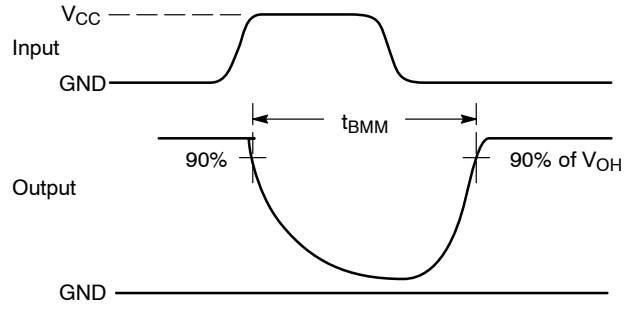
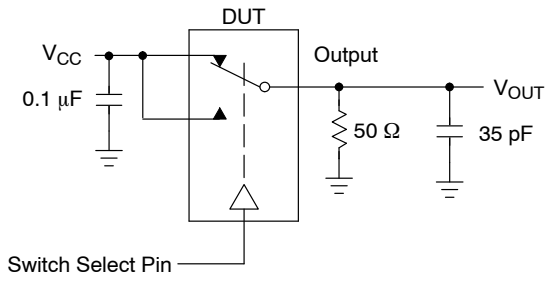

Figure 3. t_{BMM} (Time Break-Before-Make)

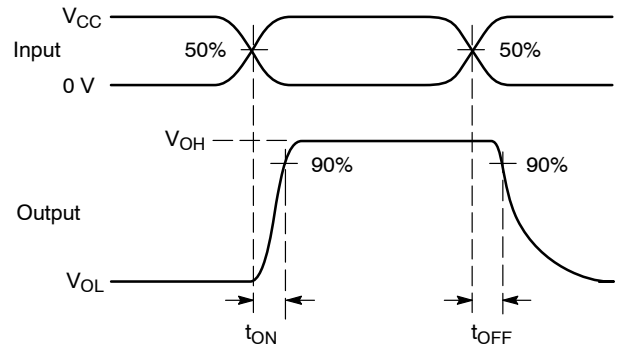
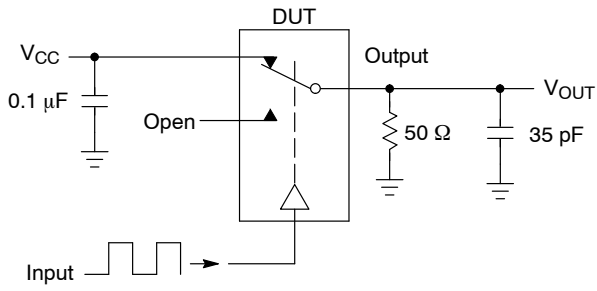

Figure 4. t_{ON}/t_{OFF}

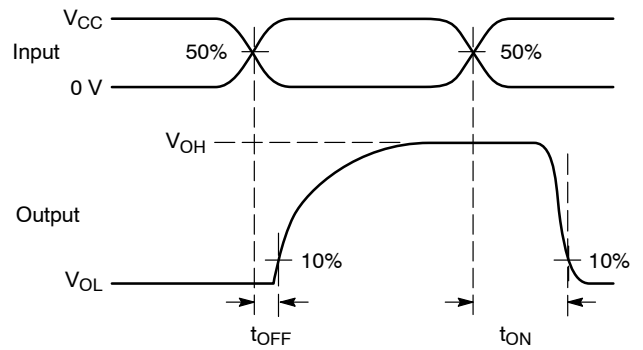
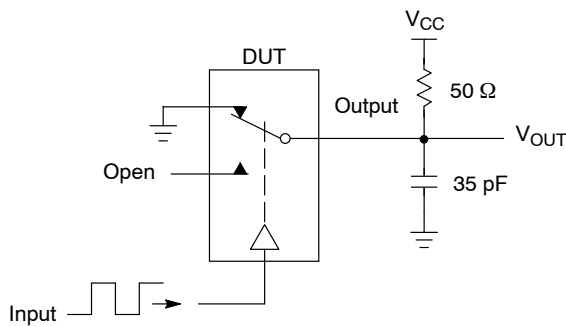
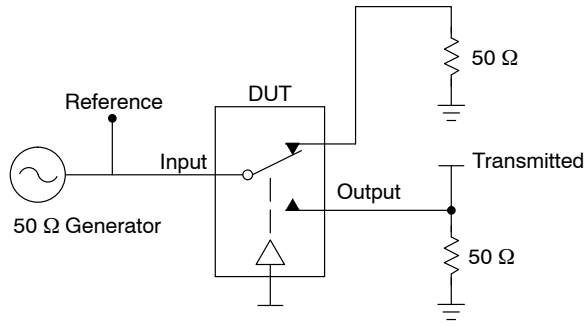

Figure 5. t_{ON}/t_{OFF}

NLAS4684



Channel switch control/s test socket is normalized. Off isolation is measured across an off channel. On loss is the bandwidth of an On switch. V_{ISO} , Bandwidth and V_{ONL} are independent of the input signal direction.

$$V_{ISO} = \text{Off Channel Isolation} = 20 \text{ Log} \left(\frac{V_{OUT}}{V_{IN}} \right) \text{ for } V_{IN} \text{ at } 100 \text{ kHz}$$

$$V_{ONL} = \text{On Channel Loss} = 20 \text{ Log} \left(\frac{V_{OUT}}{V_{IN}} \right) \text{ for } V_{IN} \text{ at } 100 \text{ kHz to } 50 \text{ MHz}$$

Bandwidth (BW) = the frequency 3 dB below V_{ONL}

V_{CT} = Use V_{ISO} setup and test to all other switch analog input/outputs terminated with 50 Ω

Figure 6. Off Channel Isolation/On Channel Loss (BW)/Crosstalk (On Channel to Off Channel)/ V_{ONL}

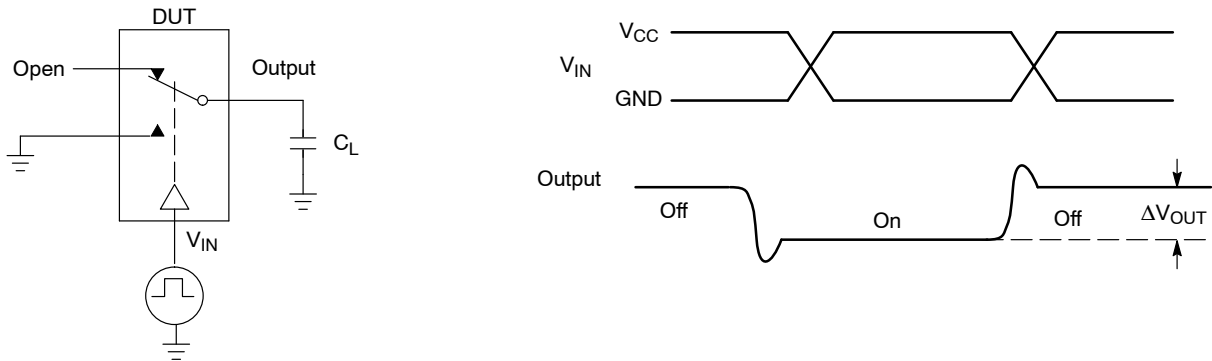

Figure 7. Charge Injection: (Q)

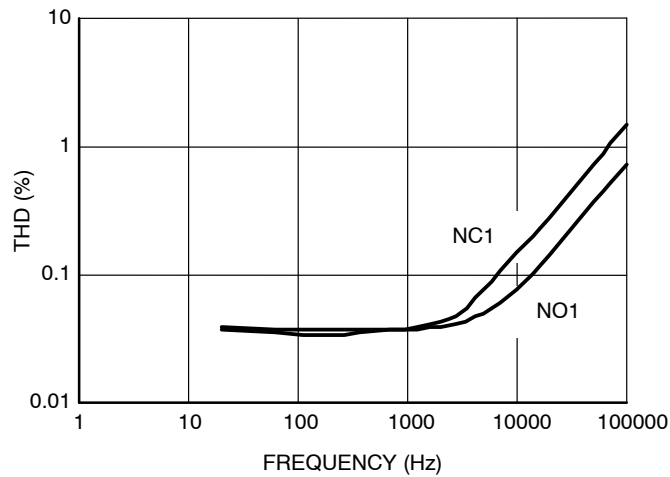

Figure 8. Total Harmonic Distortion Plus Noise Versus Frequency

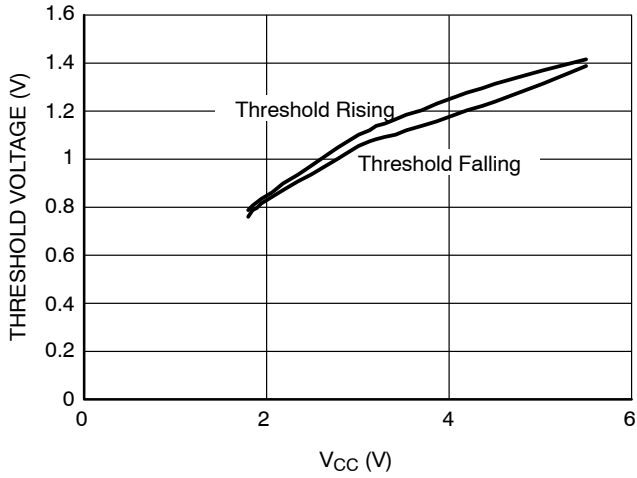

Figure 9. Voltage in Threshold on Logic Pins

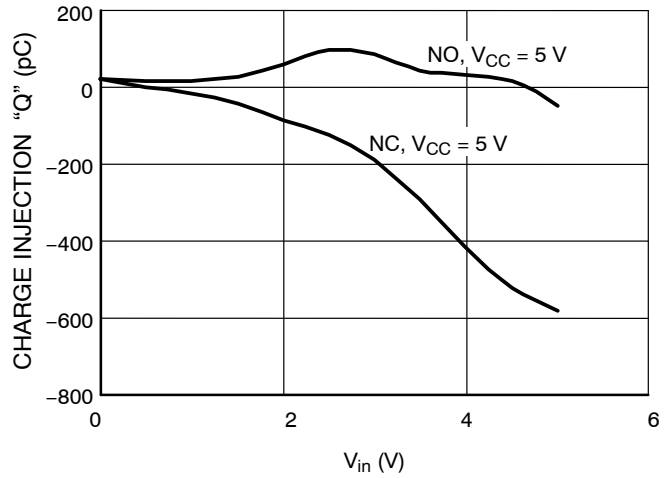

Figure 10. Charge Injection versus V_{IS}

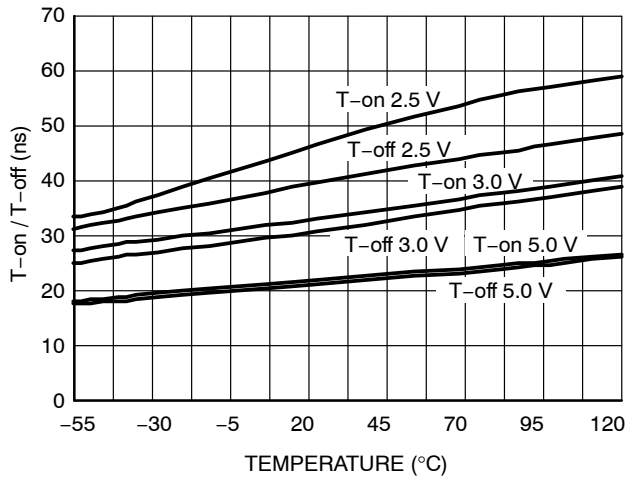

Figure 11. T-on / T-off Time versus Temperature

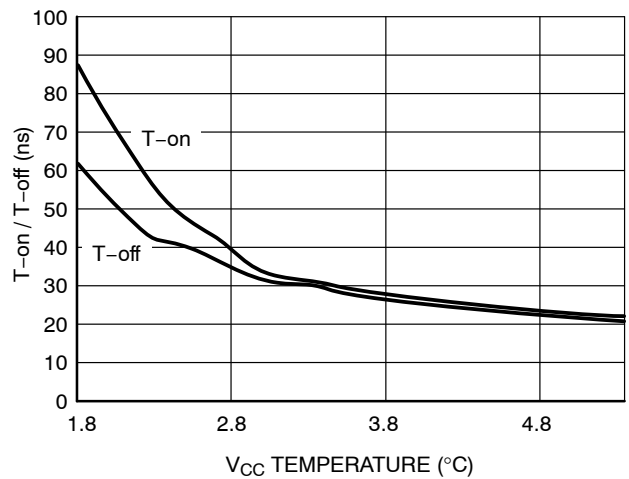

Figure 12. T-on / T-off Time versus Temperature

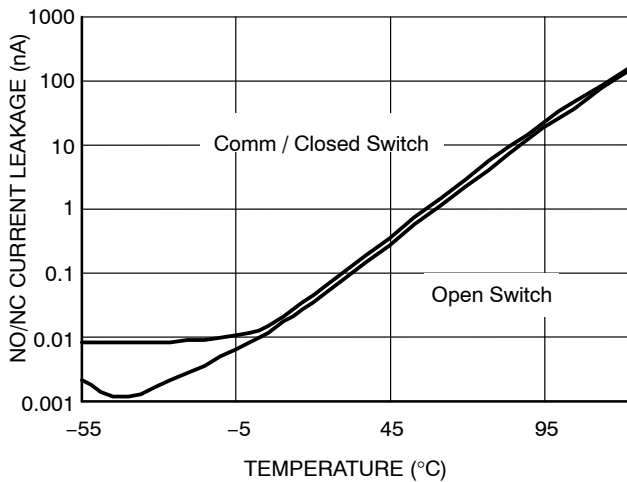

Figure 13. NO/NC Current Leakage Off and On, $V_{CC} = 5 V$

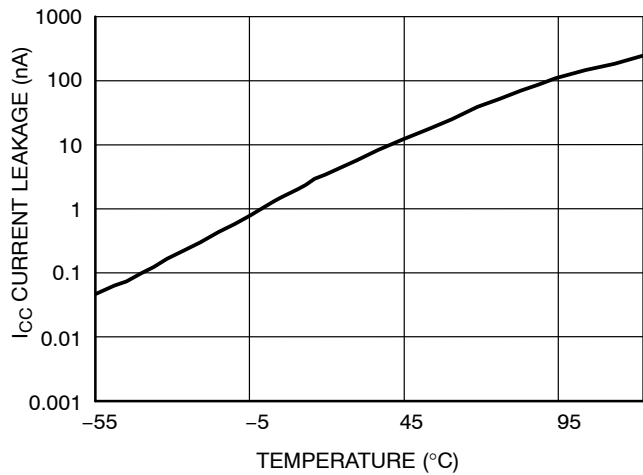

Figure 14. I_{CC} Current Leakage versus Temperature $V_{CC} = 5.5 V$

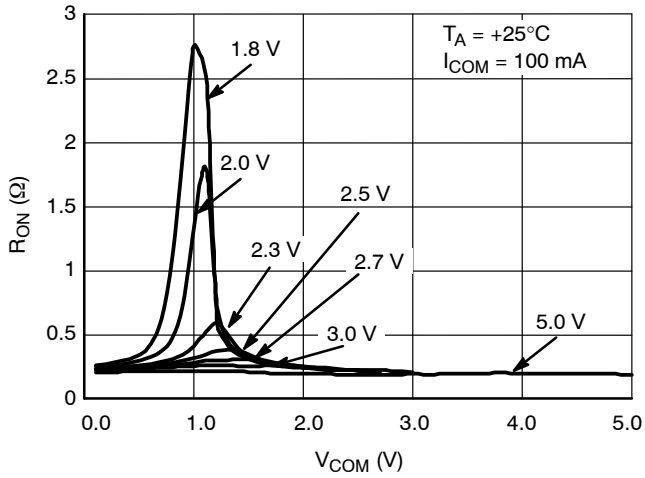

Figure 15. NC On-Resistance versus COM Voltage

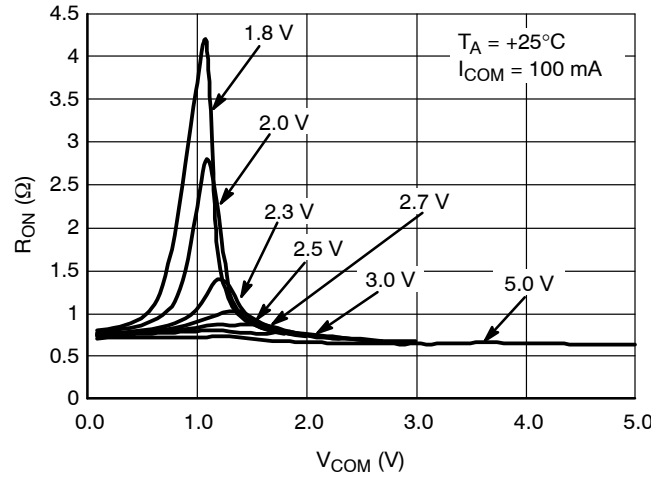

Figure 16. NO On-Resistance versus COM Voltage

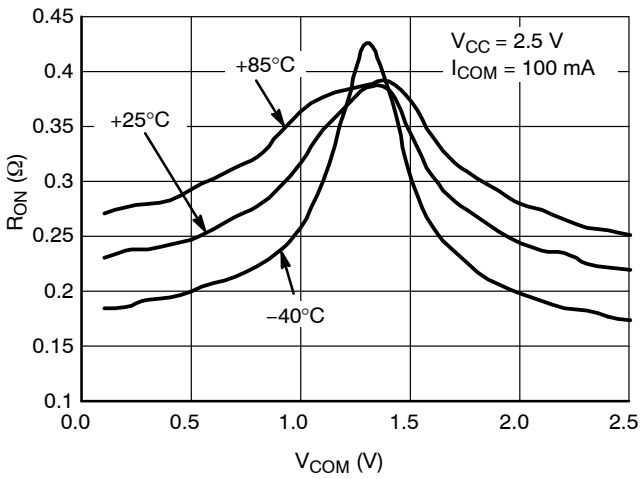

Figure 17. NC On-Resistance versus COM Voltage

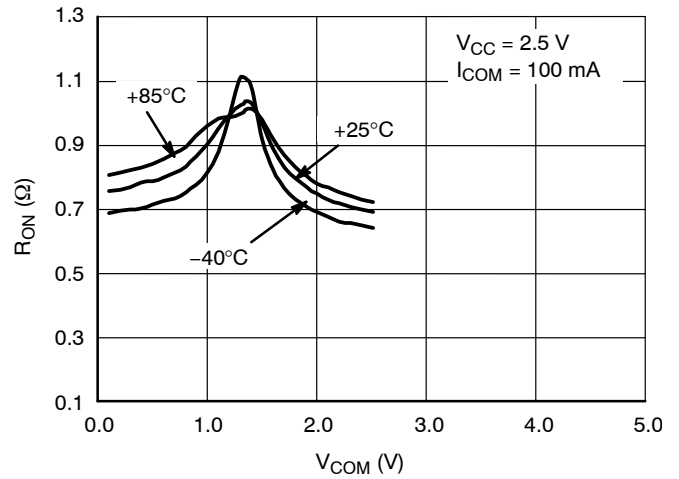

Figure 18. NO On-Resistance versus COM Voltage

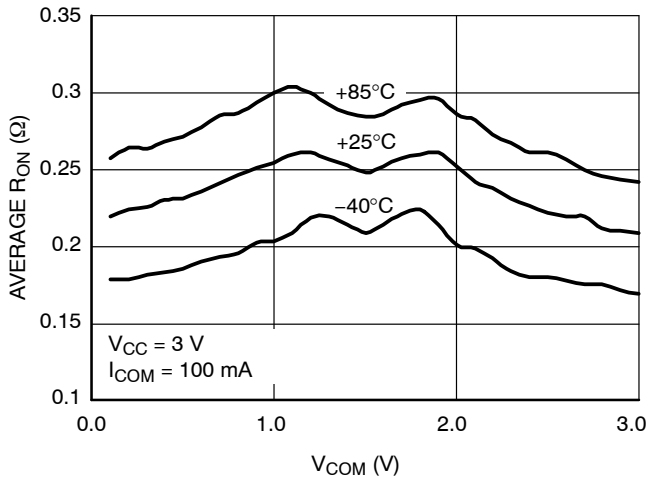

Figure 19. NC On-Resistance versus COM Voltage

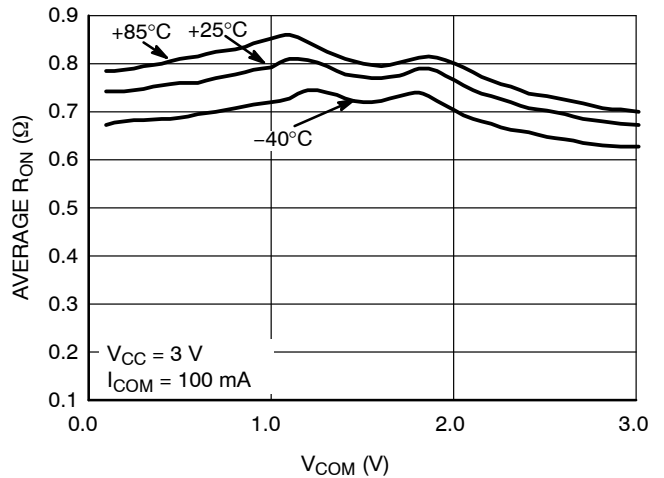

Figure 20. NC On-Resistance versus COM Voltage

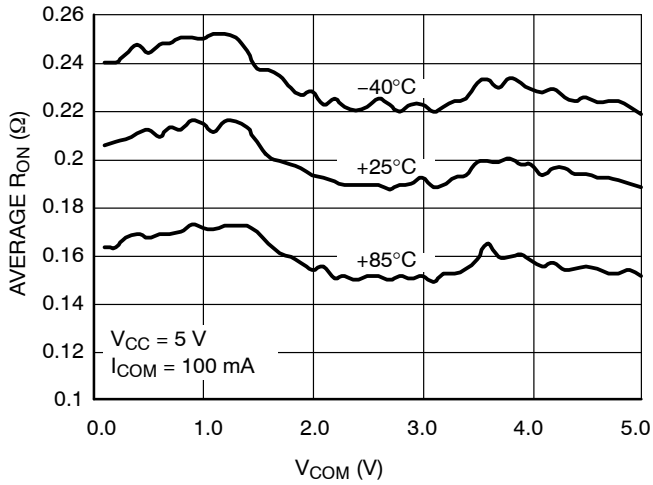

Figure 21. NC On-Resistance versus COM Voltage

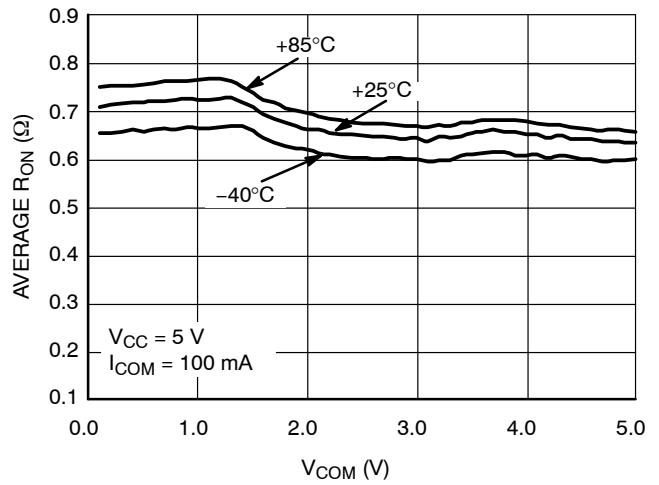

Figure 22. NO On-Resistance versus COM Voltage

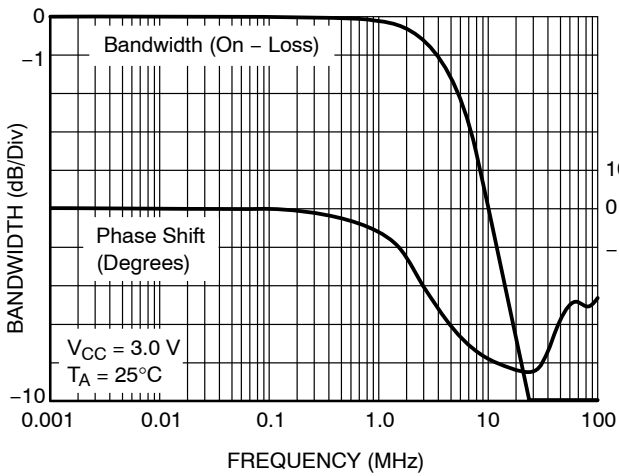

Figure 23. NC Bandwidth and Phase Shift versus Frequency

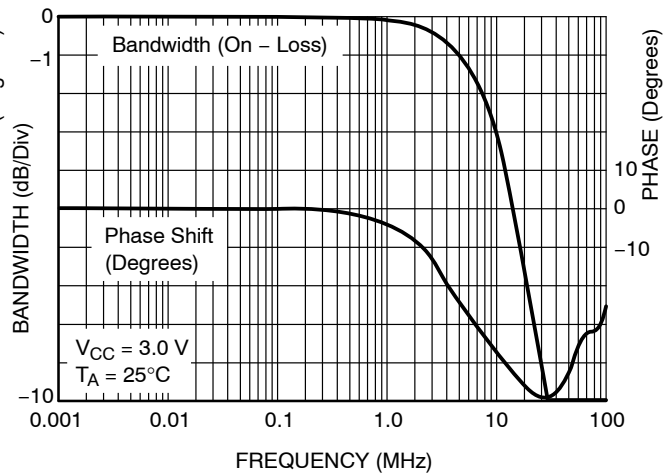

Figure 24. NO Bandwidth and Phase Shift versus Frequency

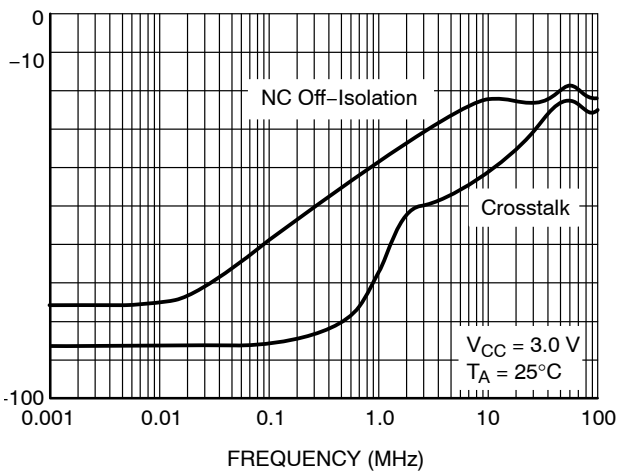

Figure 25. NC Off Isolation and Crosstalk

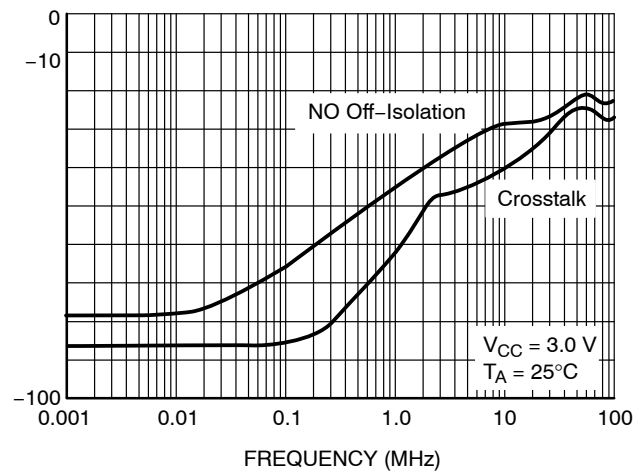

Figure 26. NO Off Isolation and Crosstalk

NLAS4684

ORDERING INFORMATION

Device	Package	Shipping†
NLAS4684FCT1	Microbump-10	3000 / Tape & Reel
NLAS4684FCT1G	Microbump-10 (Pb-Free)	3000 / Tape & Reel
NLAS4684FCTCG	Microbump-10 (Pb-Free)	3000 / Tape & Reel
NLAS4684MNR2	DFN10	3000 / Tape & Reel
NLAS4684MNR2G	DFN10 (Pb-Free)	3000 / Tape & Reel
NLAS4684MR2	Micro10	4000 / Tape & Reel
NLAS4684MR2G	Micro10 (Pb-Free)	4000 / Tape & Reel

†For information on tape and reel specifications, including part orientation and tape sizes, please refer to our Tape and Reel Packaging Specifications Brochure, BRD8011/D.

MECHANICAL CASE OUTLINE PACKAGE DIMENSIONS



SCALE 2:1

DFN10, 3x3, 0.5P CASE 485C ISSUE F

DATE 16 DEC 2021

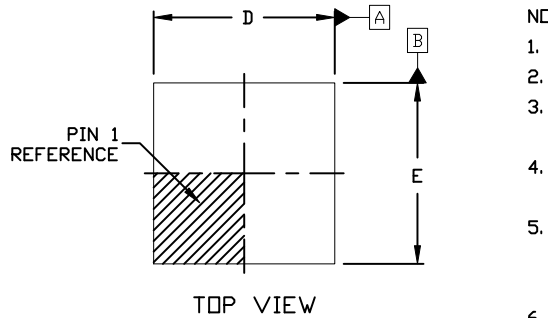

NOTES:

1. DIMENSION AND TOLERANCING PER ASME Y14.5, 2009.
2. CONTROLLING DIMENSION: MILLIMETERS
3. DIMENSION *b* APPLIES TO PLATED TERMINAL AND IS MEASURED BETWEEN 0.15 AND 0.30 MM FROM THE TERMINAL TIP.
4. COPLANARITY APPLIES TO THE EXPOSED PAD AS WELL AS THE TERMINALS.
5. TERMINAL *b* MAY HAVE MOLD COMPOUND MATERIAL ALONG SIDE EDGE. MOLD FLASH MAY NOT EXCEED 30 MICRONS ONTO BOTTOM SURFACE OF TERMINAL.
6. FOR DEVICE OPN CONTAINING W OPTION, DETAIL A AND DETAIL B ALTERNATE CONSTRUCTIONS ARE NOT APPLICABLE. WETTABLE FLANK CONSTRUCTION IS DETAIL B AS SHOWN ON SIDE VIEW OF PACKAGE.

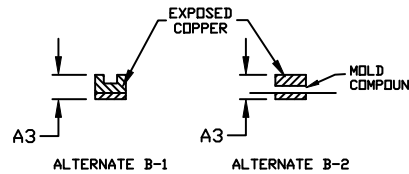
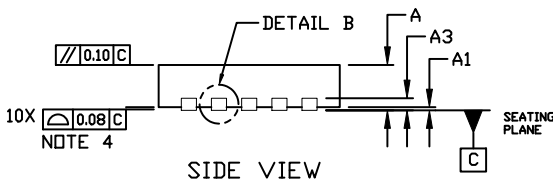

DIM	MILLIMETERS		
	MIN.	NOM.	MAX.
A	0.80	0.90	1.00
A1	0.00	---	0.05
A3	0.20 REF		
<i>b</i>	0.18	0.23	0.30
D	2.90	3.00	3.10
D2	2.40	2.50	2.60
E	2.90	3.00	3.10
E2	1.70	1.80	1.90
<i>e</i>	0.50 BSC		
K	0.20 REF		
L	0.30	0.40	0.50
L1	---	---	0.03

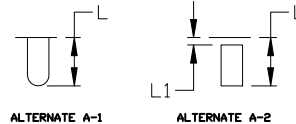
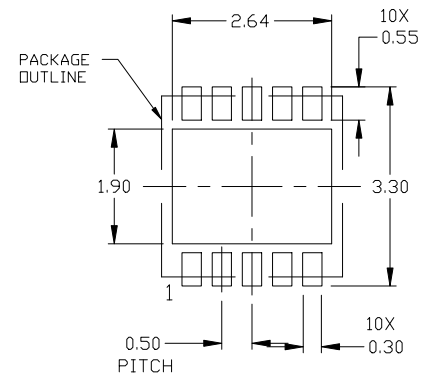
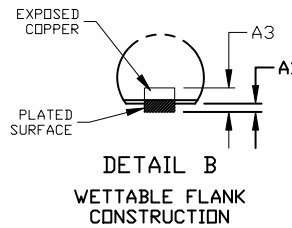
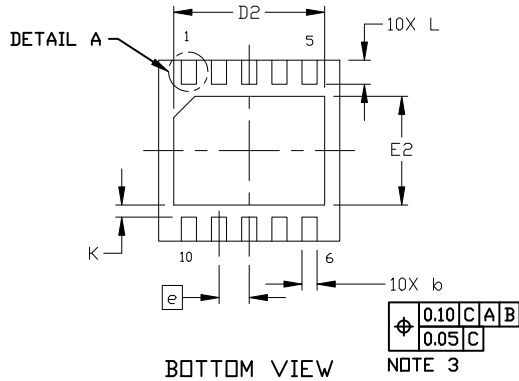

GENERIC MARKING DIAGRAM*

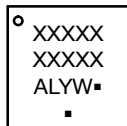

- XXXXX = Specific Device Code
- A = Assembly Location
- L = Wafer Lot
- Y = Year
- W = Work Week
- = Pb-Free Package

(Note: Microdot may be in either location)

*This information is generic. Please refer to device data sheet for actual part marking. Pb-Free indicator, "G" or microdot "▪", may or may not be present. Some products may not follow the Generic Marking.

RECOMMENDED MOUNTING FOOTPRINT

For additional information on our Pb-Free strategy and soldering details, please download the ON Semiconductor Soldering and Mounting Techniques Reference Manual, SOLDERRM/D.

DOCUMENT NUMBER:	98AON03161D	Electronic versions are uncontrolled except when accessed directly from the Document Repository. Printed versions are uncontrolled except when stamped "CONTROLLED COPY" in red.
DESCRIPTION:	DFN10, 3X3 MM, 0.5 MM PITCH	PAGE 1 OF 1

onsemi and ONSEMI are trademarks of Semiconductor Components Industries, LLC dba onsemi or its subsidiaries in the United States and/or other countries. onsemi reserves the right to make changes without further notice to any products herein. onsemi makes no warranty, representation or guarantee regarding the suitability of its products for any particular purpose, nor does onsemi assume any liability arising out of the application or use of any product or circuit, and specifically disclaims any and all liability, including without limitation special, consequential or incidental damages. onsemi does not convey any license under its patent rights nor the rights of others.

MECHANICAL CASE OUTLINE

PACKAGE DIMENSIONS

ON Semiconductor®



10 PIN FLIP-CHIP CASE 489AA-01 ISSUE A

DATE 04 MAY 2004

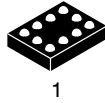

1

SCALE 4:1

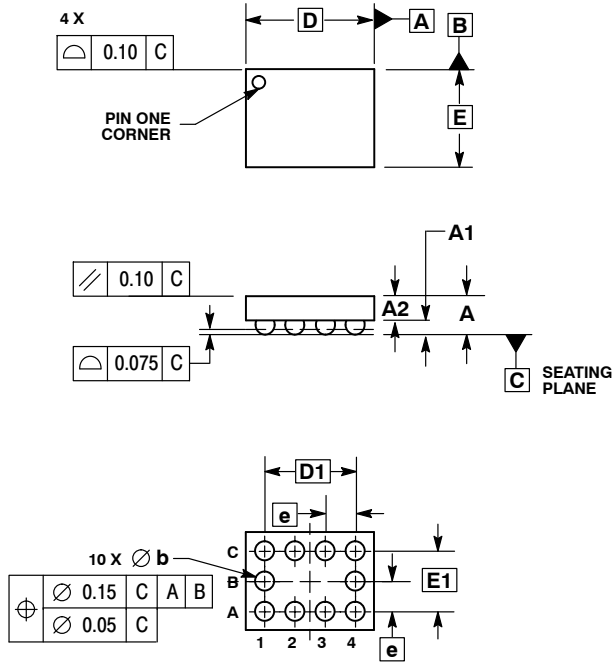

NOTES:

1. DIMENSIONING AND TOLERANCING PER ASME Y14.5M, 1994.
2. CONTROLLING DIMENSION: MILLIMETERS.
3. COPLANARITY APPLIES TO SPHERICAL CROWNS OF SOLDER BALLS.

DIM	MILLIMETERS	
	MIN	MAX
A	---	0.650
A1	0.210	0.270
A2	0.280	0.380
D	1.965 BSC	
E	1.465 BSC	
b	0.250	0.350
e	0.500 BSC	
D1	1.500 BSC	
E1	1.000 BSC	

GENERIC MARKING DIAGRAM*

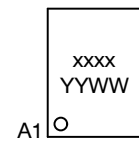

- xxxx = Specific Device Code
- YY = Year
- WW = Work Week

*This information is generic. Please refer to device data sheet for actual part marking. Pb-Free indicator, "G" or microdot "▪", may or may not be present.

DOCUMENT NUMBER:	98AON12946D	Electronic versions are uncontrolled except when accessed directly from the Document Repository. Printed versions are uncontrolled except when stamped "CONTROLLED COPY" in red.
DESCRIPTION:	10 PIN FLIP-CHIP	PAGE 1 OF 1

ON Semiconductor and ON are trademarks of Semiconductor Components Industries, LLC dba ON Semiconductor or its subsidiaries in the United States and/or other countries. ON Semiconductor reserves the right to make changes without further notice to any products herein. ON Semiconductor makes no warranty, representation or guarantee regarding the suitability of its products for any particular purpose, nor does ON Semiconductor assume any liability arising out of the application or use of any product or circuit, and specifically disclaims any and all liability, including without limitation special, consequential or incidental damages. ON Semiconductor does not convey any license under its patent rights nor the rights of others.

MECHANICAL CASE OUTLINE PACKAGE DIMENSIONS

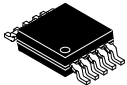

SCALE 2:1

Micro10
CASE 846B-03
ISSUE D

DATE 07 DEC 2004

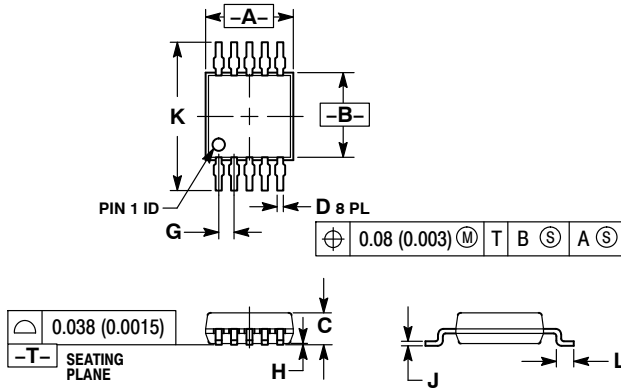

SOLDERING FOOTPRINT

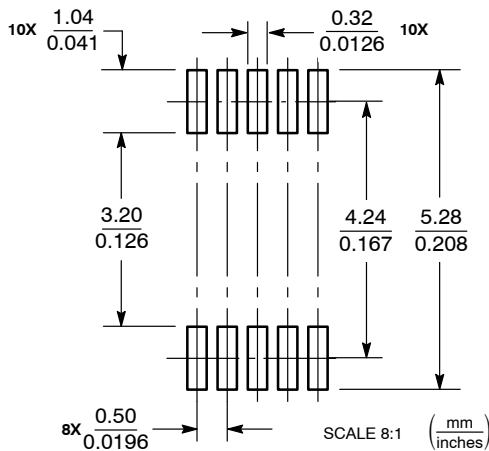

Micro10

NOTES:

1. DIMENSIONING AND TOLERANCING PER ANSI Y14.5M, 1982.
2. CONTROLLING DIMENSION: MILLIMETER.
3. DIMENSION "A" DOES NOT INCLUDE MOLD FLASH, PROTRUSIONS OR GATE BURRS. MOLD FLASH, PROTRUSIONS OR GATE BURRS SHALL NOT EXCEED 0.15 (0.006) PER SIDE.
4. DIMENSION "B" DOES NOT INCLUDE INTERLEAD FLASH OR PROTRUSION. INTERLEAD FLASH OR PROTRUSION SHALL NOT EXCEED 0.25 (0.010) PER SIDE.
5. 846B-01 OBSOLETE. NEW STANDARD 846B-02

DIM	MILLIMETERS		INCHES	
	MIN	MAX	MIN	MAX
A	2.90	3.10	0.114	0.122
B	2.90	3.10	0.114	0.122
C	0.95	1.10	0.037	0.043
D	0.20	0.30	0.008	0.012
G	0.50 BSC		0.020 BSC	
H	0.05	0.15	0.002	0.006
J	0.10	0.21	0.004	0.008
K	4.75	5.05	0.187	0.199
L	0.40	0.70	0.016	0.028

GENERIC MARKING DIAGRAM*

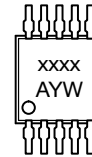

- xxxx = Device Code
- A = Assembly Location
- Y = Year
- W = Work Week
- = Pb-Free Package

*This information is generic. Please refer to device data sheet for actual part marking. Pb-Free indicator, "G" or microdot "▪", may or may not be present. Some products may not follow the Generic Marking.

DOCUMENT NUMBER:	98AON03799D	Electronic versions are uncontrolled except when accessed directly from the Document Repository. Printed versions are uncontrolled except when stamped "CONTROLLED COPY" in red.
DESCRIPTION:	Micro10	PAGE 1 OF 1

onsemi and ONSEMI are trademarks of Semiconductor Components Industries, LLC dba onsemi or its subsidiaries in the United States and/or other countries. onsemi reserves the right to make changes without further notice to any products herein. onsemi makes no warranty, representation or guarantee regarding the suitability of its products for any particular purpose, nor does onsemi assume any liability arising out of the application or use of any product or circuit, and specifically disclaims any and all liability, including without limitation special, consequential or incidental damages. onsemi does not convey any license under its patent rights nor the rights of others.

onsemi, **Onsemi**, and other names, marks, and brands are registered and/or common law trademarks of Semiconductor Components Industries, LLC dba "**onsemi**" or its affiliates and/or subsidiaries in the United States and/or other countries. **onsemi** owns the rights to a number of patents, trademarks, copyrights, trade secrets, and other intellectual property. A listing of **onsemi**'s product/patent coverage may be accessed at www.onsemi.com/site/pdf/Patent-Marking.pdf. **onsemi** reserves the right to make changes at any time to any products or information herein, without notice. The information herein is provided "as-is" and **onsemi** makes no warranty, representation or guarantee regarding the accuracy of the information, product features, availability, functionality, or suitability of its products for any particular purpose, nor does **onsemi** assume any liability arising out of the application or use of any product or circuit, and specifically disclaims any and all liability, including without limitation special, consequential or incidental damages. Buyer is responsible for its products and applications using **onsemi** products, including compliance with all laws, regulations and safety requirements or standards, regardless of any support or applications information provided by **onsemi**. "Typical" parameters which may be provided in **onsemi** data sheets and/or specifications can and do vary in different applications and actual performance may vary over time. All operating parameters, including "Typicals" must be validated for each customer application by customer's technical experts. **onsemi** does not convey any license under any of its intellectual property rights nor the rights of others. **onsemi** products are not designed, intended, or authorized for use as a critical component in life support systems or any FDA Class 3 medical devices or medical devices with a same or similar classification in a foreign jurisdiction or any devices intended for implantation in the human body. Should Buyer purchase or use **onsemi** products for any such unintended or unauthorized application, Buyer shall indemnify and hold **onsemi** and its officers, employees, subsidiaries, affiliates, and distributors harmless against all claims, costs, damages, and expenses, and reasonable attorney fees arising out of, directly or indirectly, any claim of personal injury or death associated with such unintended or unauthorized use, even if such claim alleges that **onsemi** was negligent regarding the design or manufacture of the part. **onsemi** is an Equal Opportunity/Affirmative Action Employer. This literature is subject to all applicable copyright laws and is not for resale in any manner.

ADDITIONAL INFORMATION

TECHNICAL PUBLICATIONS:

Technical Library: www.onsemi.com/design/resources/technical-documentation
onsemi Website: www.onsemi.com

ONLINE SUPPORT: www.onsemi.com/support

For additional information, please contact your local Sales Representative at www.onsemi.com/support/sales

