

# Switching Regulator - Automotive Buck

1.2 A, 2 MHz

## NCV890100

The NCV890100 is a fixed-frequency, monolithic, Buck switching regulator intended for Automotive, battery-connected applications that must operate with up to a 36 V input supply. The regulator is suitable for systems with low noise and small form factor requirements often encountered in automotive driver information systems. The NCV890100 is capable of converting the typical 4.5 V to 18 V automotive input voltage range to outputs as low as 3.3 V at a constant switching frequency above the sensitive AM band, eliminating the need for costly filters and EMI countermeasures. The NCV890100 also provides several protection features expected in Automotive power supply systems such as current limit, short circuit protection, and thermal shutdown. In addition, the high switching frequency produces low output voltage ripple even when using small inductor values and an all-ceramic output filter capacitor – forming a space-efficient switching regulator solution.

### Features

- Internal N-Channel Power Switch
- Low  $V_{IN}$  Operation Down to 4.5 V
- High  $V_{IN}$  Operation to 36 V
- Withstands Load Dump to 40 V
- 2 MHz Free-running Switching Frequency
- Logic Level Enable Input Can be Directly Tied to Battery
- 1.4 A (min) Cycle-by-Cycle Peak Current Limit
- Short Circuit Protection Enhanced by Frequency Foldback
- $\pm 1.75\%$  Output Voltage Tolerance
- Output Voltage Adjustable Down to 0.8 V
- 1.4 Millisecond Internal Soft-Start
- Thermal Shutdown (TSD)
- Low Shutdown Current
- Wettable Flanks DFN
- NCV Prefix for Automotive and Other Applications Requiring Unique Site and Control Change Requirements; AEC-Q100 Qualified and PPAP Capable
- These Devices are Pb-Free and are RoHS Compliant

### Applications

- Audio
- Infotainment
- Safety – Vision Systems
- Instrumentation



DFN8  
CASE 506BY

### MARKING DIAGRAMS

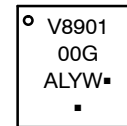

- A = Assembly Location
- L = Wafer Lot
- Y = Year
- W = Work Week
- = Pb-Free Device

(Note: Microdot may be in either location)

### ORDERING INFORMATION

See detailed ordering and shipping information in the package dimensions section on page 17 of this data sheet.

# NCV890100

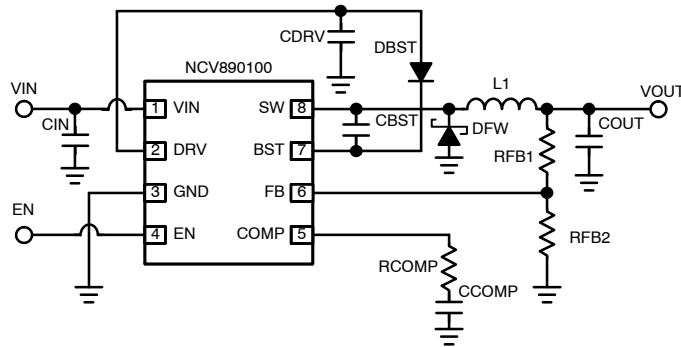

Figure 1. Typical Application

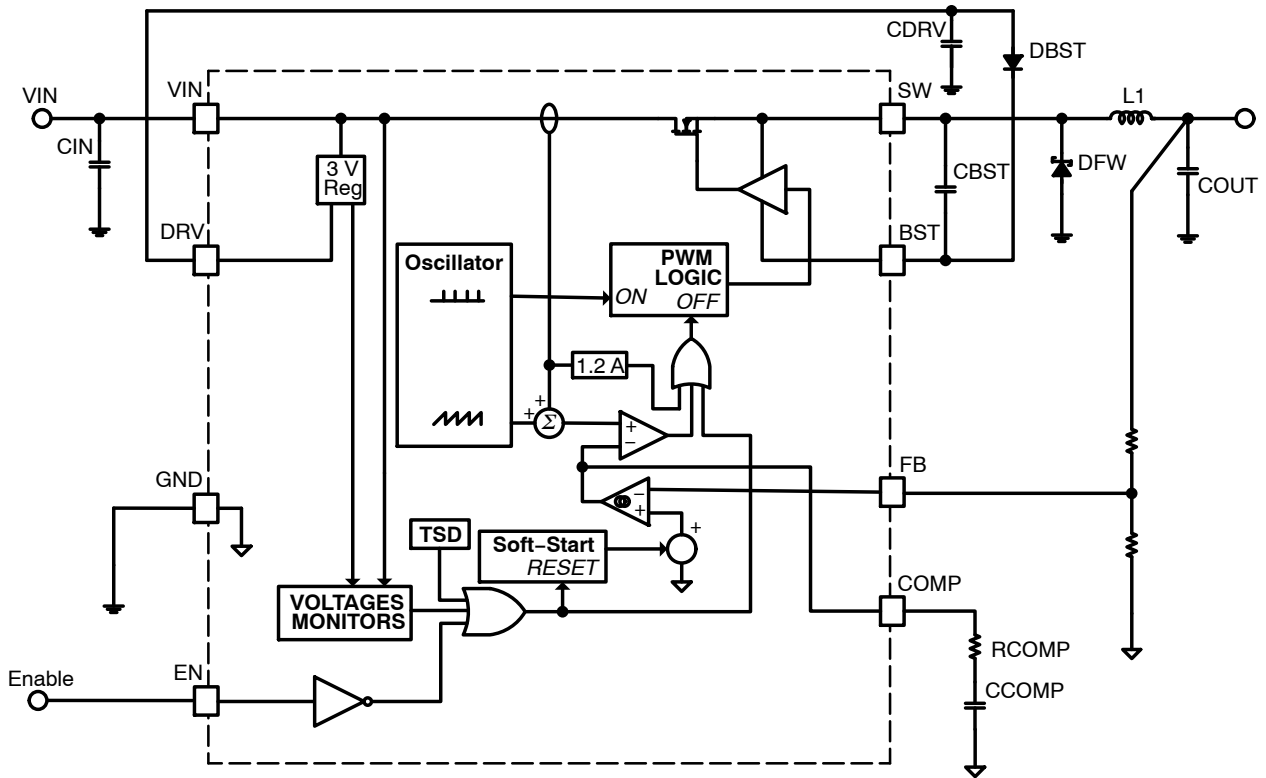

Figure 2. NCV890100 Block Diagram

**MAXIMUM RATINGS**

| Rating   | Symbol   | Value       | Unit |
|--|--|-------------|------|
| Min/Max Voltage VIN                                |  | -0.3 to 40  | V    |
| Max Voltage VIN to SW                              |  | 40          | V    |
| Min/Max Voltage SW                                 |  | -0.7 to 40  | V    |
| Min Voltage SW – 20ns                              |  | -3.0        | V    |
| Min/Max Voltage BST                                |  | -0.3 to 40  |      |
| Min/Max Voltage BST to SW                          |  | -0.3 to 3.6 | V    |
| Min/Max Voltage on EN                              |  | -0.3 to 40  | V    |
| Min/Max Voltage COMP                               |  | -0.3 to 2   | V    |
| Min/Max Voltage FB                                 |  | -0.3 to 18  | V    |
| Min/Max Voltage DRV                                |  | -0.3 to 3.6 | V    |
| Thermal Resistance, 3x3 DFN Junction-to-Ambient*   | R <sub>θJA</sub>   | 50          | °C/W |
| Thermal Resistance, SOIC-8 EP Junction-to-Ambient* | R <sub>θJA</sub>   | 40          | °C/W |
| Storage Temperature range                          |  | -55 to +150 | °C   |
| Operating Junction Temperature Range               | T <sub>J</sub>   | -40 to +150 | °C   |
| ESD withstand Voltage                              | Human Body Model<br>Machine Model<br>Charge Device Model | 2.0         | kV   |
|  |  | 200         | V    |
|  |  | >1.0        | kV   |
| Moisture Sensitivity, DFN8                         | MSL  | Level 1     |      |
| Moisture Sensitivity, SOIC-8 EP                    | MSL  | Level 2     |      |
| Peak Reflow Soldering Temperature                  |  | 260         | °C   |

Stresses exceeding those listed in the Maximum Ratings table may damage the device. If any of these limits are exceeded, device functionality should not be assumed, damage may occur and reliability may be affected.

\*Mounted on 1 sq. in. of a 4-layer PCB with 1 oz. copper thickness.

## NCV890100

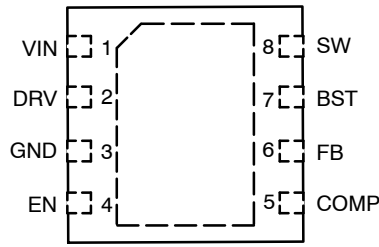

**Figure 3. Pin Connections**

### PIN FUNCTION DESCRIPTIONS

| Pin No.     | Symbol | Description  |
|-------------|--------|--|
| 1           | VIN    | Input voltage from battery. Place an input filter capacitor in close proximity to this pin.  |
| 2           | DRV    | Output voltage to provide a regulated voltage to the Power Switch gate driver.   |
| 3           | GND    | Battery return, and output voltage ground reference.   |
| 4           | EN     | This TTL compatible Enable input allows the direct connection of Battery as the enable signal. Grounding this input stops switching and reduces quiescent current draw to a minimum. |
| 5           | COMP   | Error Amplifier output, for tailoring transient response with external compensation components.  |
| 6           | FB     | Feedback input pin to program output voltage, and detect pre-charged or shorted output conditions.   |
| 7           | BST    | Bootstrap input provides drive voltage higher than VIN to the N-channel Power Switch for optimum switch $R_{DS(on)}$ and highest efficiency.   |
| 8           | SW     | Switching node of the Regulator. Connect the output inductor and cathode of the freewheeling diode to this pin.  |
| Exposed Pad |        | Connect to Pin 3 (electrical ground) and to a low thermal resistance path to the ambient temperature environment.  |

# NCV890100

**ELECTRICAL CHARACTERISTICS** ( $V_{IN} = 4.5\text{ V to }28\text{ V}$ ,  $V_{EN} = 5\text{ V}$ ,  $V_{BST} = V_{SW} + 3.0\text{ V}$ ,  $C_{DRV} = 0.1\text{ }\mu\text{F}$ , Min/Max values are valid for the temperature range  $-40^{\circ}\text{C} \leq T_J \leq 150^{\circ}\text{C}$  unless noted otherwise, and are guaranteed by test, design or statistical correlation.)

| Parameter | Symbol | Conditions | Min | Typ | Max | Unit |
|-----------|--------|------------|-----|-----|-----|------|
|-----------|--------|------------|-----|-----|-----|------|

## QUIESCENT CURRENT

|                             |           |   |  |  |   |               |
|-----------------------------|-----------|---|--|--|---|---------------|
| Quiescent Current, shutdown | $I_{qSD}$ | $V_{IN} = 13.2\text{ V}$ , $V_{EN} = 0\text{ V}$ , $T_J = 25^{\circ}\text{C}$ |  |  | 5 | $\mu\text{A}$ |
| Quiescent Current, enabled  | $I_{qEN}$ | $V_{IN} = 13.2\text{ V}$  |  |  | 3 | $\text{mA}$   |

## UNDERVOLTAGE LOCKOUT - VIN (UVLO)

|                      |              |                  |     |  |     |   |
|----------------------|--------------|------------------|-----|--|-----|---|
| UVLO Start Threshold | $V_{UVLSTT}$ | $V_{IN}$ rising  | 4.1 |  | 4.5 | V |
| UVLO Stop Threshold  | $V_{UVLSTP}$ | $V_{IN}$ falling | 3.9 |  | 4.4 | V |
| UVLO Hysteresis      | $V_{UVLOHY}$ |                  | 0.1 |  | 0.2 | V |

## ENABLE (EN)

|               |            |  |     |  |    |               |
|---------------|------------|--|-----|--|----|---------------|
| Logic Low     | $V_{ENLO}$ |  | 0.8 |  |    | V             |
| Logic High    | $V_{ENHI}$ |  |     |  | 2  | V             |
| Input Current | $I_{EN}$   |  | 8   |  | 30 | $\mu\text{A}$ |

## SOFT-START (SS)

|                            |          |  |     |     |     |    |
|----------------------------|----------|--|-----|-----|-----|----|
| Soft-Start Completion Time | $t_{SS}$ |  | 0.8 | 1.4 | 2.0 | ms |
|----------------------------|----------|--|-----|-----|-----|----|

## VOLTAGE REFERENCE

|                                  |           |                    |       |     |       |   |
|----------------------------------|-----------|--------------------|-------|-----|-------|---|
| FB Pin Voltage during regulation | $V_{FBR}$ | COMP shorted to FB | 0.786 | 0.8 | 0.814 | V |
|----------------------------------|-----------|--------------------|-------|-----|-------|---|

## ERROR AMPLIFIER

|                           |                      |   |            |          |             |                  |
|---------------------------|----------------------|---|------------|----------|-------------|------------------|
| FB Bias Current           | $I_{FBBIAS}$         | $V_{FB} = 0.8\text{ V}$   | 0.25       |          | 1           | $\mu\text{A}$    |
| Transconductance          | $g_m$<br>$g_{m(HV)}$ | $V_{COMP} = 1.3\text{ V}$<br>$4.5\text{ V} < V_{IN} < 18\text{ V}$<br>$20\text{ V} < V_{IN} < 28\text{ V}$                            | 0.6<br>0.3 | 1<br>0.5 | 1.5<br>0.75 | mmho             |
| Output Resistance         | $R_{OUT}$            |   |            | 1.4      |             | $\text{M}\Omega$ |
| COMP Source Current Limit | $I_{SOURCE}$         | $V_{FB} = 0.63\text{ V}$ , $V_{COMP} = 1.3\text{ V}$<br>$4.5\text{ V} < V_{IN} < 18\text{ V}$<br>$20\text{ V} < V_{IN} < 28\text{ V}$ |            | 75<br>40 |             | $\mu\text{A}$    |
| COMP Sink Current Limit   | $I_{SINK}$           | $V_{FB} = 0.97\text{ V}$ , $V_{COMP} = 1.3\text{ V}$<br>$4.5\text{ V} < V_{IN} < 18\text{ V}$<br>$20\text{ V} < V_{IN} < 28\text{ V}$ |            | 75<br>40 |             | $\mu\text{A}$    |
| Minimum COMP voltage      | $V_{CMPMIN}$         | $V_{FB} = 0.97\text{ V}$  | 0.2        |          | 0.7         | V                |

## OSCILLATOR

|           |                          |  |            |            |            |     |
|-----------|--------------------------|--|------------|------------|------------|-----|
| Frequency | $F_{SW}$<br>$F_{SW(HV)}$ | $4.5 < V_{IN} < 18\text{ V}$<br>$20\text{ V} < V_{IN} < 28\text{ V}$ | 1.8<br>0.9 | 2.0<br>1.0 | 2.2<br>1.1 | MHz |
|-----------|--------------------------|--|------------|------------|------------|-----|

## VIN FREQUENCY FOLDBACK MONITOR

|   |                            |                          |            |     |            |   |
|---|----------------------------|--------------------------|------------|-----|------------|---|
| Frequency Foldback Threshold<br>$V_{IN}$ rising<br>$V_{IN}$ falling | $V_{FLDUP}$<br>$V_{FLDDN}$ | $V_{FB} = 0.63\text{ V}$ | 18.4<br>18 |     | 20<br>19.8 | V |
| Frequency Foldback Hysteresis                                       | $V_{FLDHY}$                |                          | 0.2        | 0.3 | 0.4        | V |

## SLOPE COMPENSATION

|   |                              |  |             |  |            |                        |
|---|------------------------------|--|-------------|--|------------|------------------------|
| Ramp Slope (Note 1)<br>(With respect to switch current) | $S_{ramp}$<br>$S_{ramp(HV)}$ | $4.5 < V_{IN} < 18\text{ V}$<br>$20\text{ V} < V_{IN} < 28\text{ V}$ | 0.7<br>0.25 |  | 1.3<br>0.6 | $\text{A}/\mu\text{s}$ |
|---|------------------------------|--|-------------|--|------------|------------------------|

1. Not tested in production. Limits are guaranteed by design.

# NCV890100

**ELECTRICAL CHARACTERISTICS** ( $V_{IN} = 4.5\text{ V to }28\text{ V}$ ,  $V_{EN} = 5\text{ V}$ ,  $V_{BST} = V_{SW} + 3.0\text{ V}$ ,  $C_{DRV} = 0.1\text{ }\mu\text{F}$ , Min/Max values are valid for the temperature range  $-40^{\circ}\text{C} \leq T_J \leq 150^{\circ}\text{C}$  unless noted otherwise, and are guaranteed by test, design or statistical correlation.)

| Parameter | Symbol | Conditions | Min | Typ | Max | Unit |
|-----------|--------|------------|-----|-----|-----|------|
|-----------|--------|------------|-----|-----|-----|------|

## POWER SWITCH

|                           |              |  |    |          |     |               |
|---------------------------|--------------|--|----|----------|-----|---------------|
| ON Resistance             | $R_{DSON}$   | $V_{BST} = V_{SW} + 3.0\text{ V}$  |    |          | 650 | m $\Omega$    |
| Leakage current VIN to SW | $I_{LKSW}$   | $V_{EN} = 0\text{ V}$ , $V_{SW} = 0$ , $V_{IN} = 18\text{ V}$  |    |          | 10  | $\mu\text{A}$ |
| Minimum ON Time           | $t_{ONMIN}$  | Measured at SW pin   | 45 |          | 70  | ns            |
| Minimum OFF Time          | $t_{OFFMIN}$ | Measured at SW pin<br>At $F_{SW} = 2\text{ MHz}$ (normal)<br>At $F_{SW} = 500\text{ kHz}$ (max duty cycle) | 30 | 30<br>50 | 70  | ns            |

## PEAK CURRENT LIMIT

|                         |           |  |     |      |     |   |
|-------------------------|-----------|--|-----|------|-----|---|
| Current Limit Threshold | $I_{LIM}$ |  | 1.4 | 1.55 | 1.7 | A |
|-------------------------|-----------|--|-----|------|-----|---|

## SHORT CIRCUIT FREQUENCY FOLDBACK

|   |              |   |     |     |     |     |
|---|--------------|---|-----|-----|-----|-----|
| Lowest Foldback Frequency                 | $F_{SWAF}$   | $V_{FB} = 0\text{ V}$ , $4.5\text{ V} < V_{IN} < 18\text{ V}$ | 400 | 500 | 600 | kHz |
| Lowest Foldback Frequency – High $V_{in}$ | $F_{SWAFHV}$ | $V_{FB} = 0\text{ V}$ , $20\text{ V} < V_{IN} < 28\text{ V}$  | 200 | 250 | 300 |     |
| Hiccup Mode                               | $F_{SWHIC}$  | $V_{FB} = 0\text{ V}$   | 24  | 32  | 40  |     |

## GATE VOLTAGE SUPPLY (DRV pin)

|                         |              |                        |     |     |      |    |
|-------------------------|--------------|------------------------|-----|-----|------|----|
| Output Voltage          | $V_{DRV}$    |                        | 3.1 | 3.3 | 3.5  | V  |
| DRV POR Start Threshold | $V_{DRVSTT}$ |                        | 2.7 | 2.9 | 3.05 | V  |
| DRV POR Stop Threshold  | $V_{DRVSTP}$ |                        | 2.5 | 2.8 | 3.0  | V  |
| DRV Current Limit       | $I_{DRVLIM}$ | $V_{DRV} = 0\text{ V}$ | 16  |     | 45   | mA |

## OUTPUT PRECHARGE DETECTOR

|                   |            |  |    |    |    |    |
|-------------------|------------|--|----|----|----|----|
| Threshold Voltage | $V_{SSEN}$ |  | 20 | 35 | 50 | mV |
|-------------------|------------|--|----|----|----|----|

## THERMAL SHUTDOWN

|                                 |           |  |     |  |     |                    |
|---------------------------------|-----------|--|-----|--|-----|--------------------|
| Activation Temperature (Note 1) | $T_{SD}$  |  | 150 |  | 190 | $^{\circ}\text{C}$ |
| Hysteresis (Note 1)             | $T_{HYS}$ |  | 5   |  | 20  | $^{\circ}\text{C}$ |

1. Not tested in production. Limits are guaranteed by design.

Product parametric performance is indicated in the Electrical Characteristics for the listed test conditions, unless otherwise noted. Product performance may not be indicated by the Electrical Characteristics if operated under different conditions.

TYPICAL CHARACTERISTICS CURVES



Figure 4. Shutdown Quiescent Current vs. Junction Temperature



Figure 5. Enabled Quiescent Current vs. Junction Temperature



Figure 6. UVLO Start Threshold vs. Junction Temperature



Figure 7. UVLO Stop Threshold vs. Junction Temperature



Figure 8. Soft-Start Duration vs. Junction Temperature



Figure 9. FB Regulation Voltage vs. Junction Temperature

TYPICAL CHARACTERISTICS CURVES

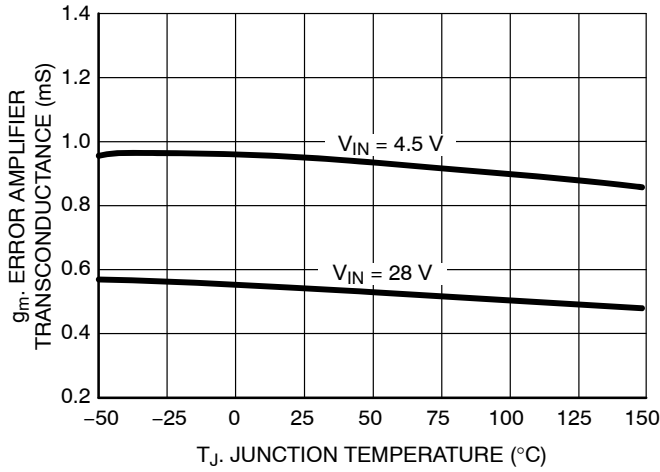

Figure 10. Error Amplifier Transconductance vs. Junction Temperature

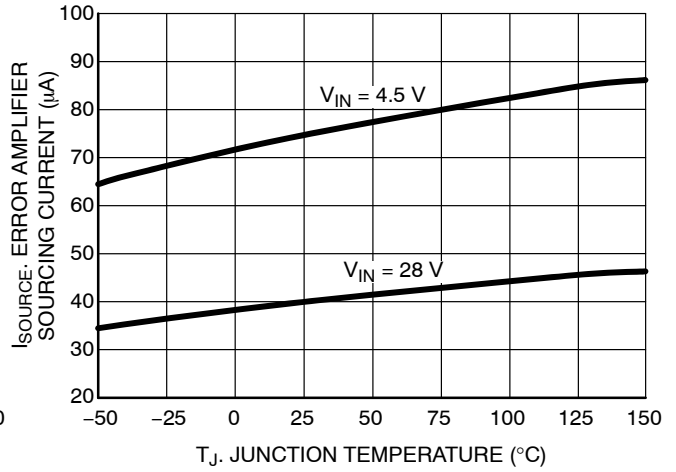

Figure 11. Error Amplifier Max Sourcing Current vs. Junction Temperature

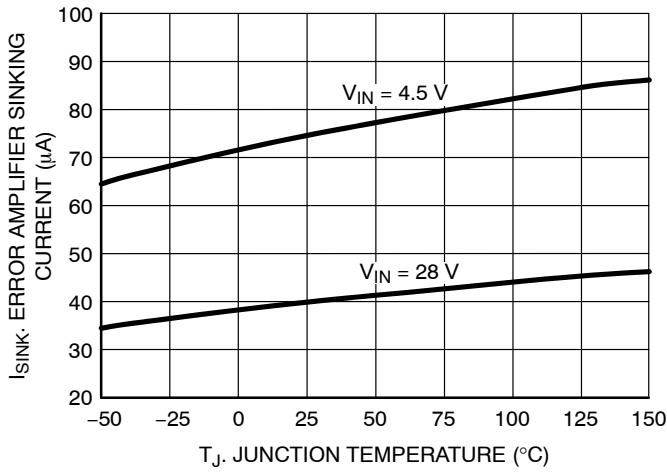

Figure 12. Error Amplifier Max Sinking Current vs. Junction Temperature

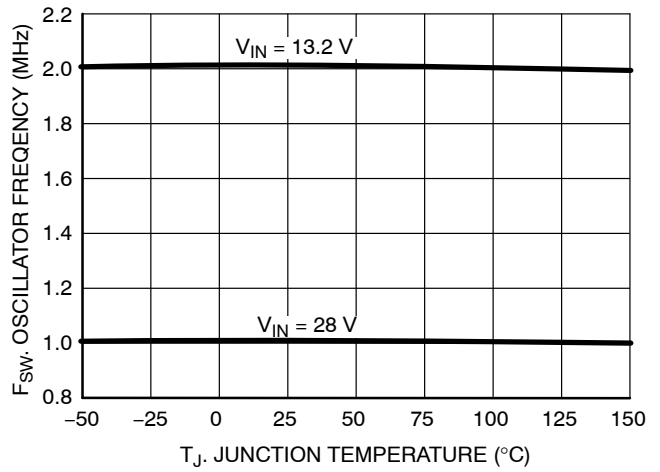

Figure 13. Oscillator Frequency vs. Junction Temperature

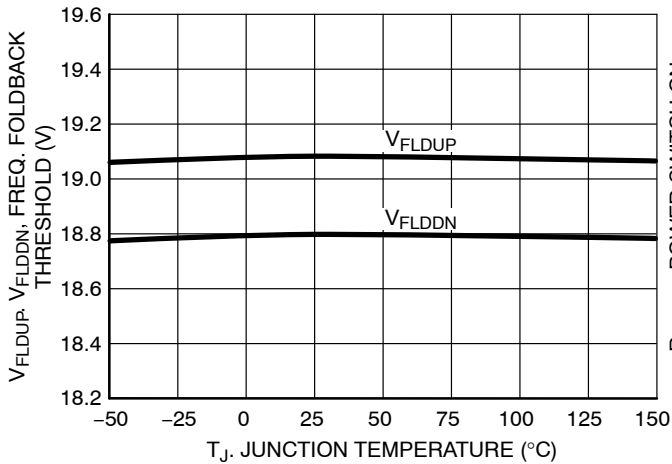

Figure 14. Rising Frequency Foldback Threshold vs. Junction Temperature

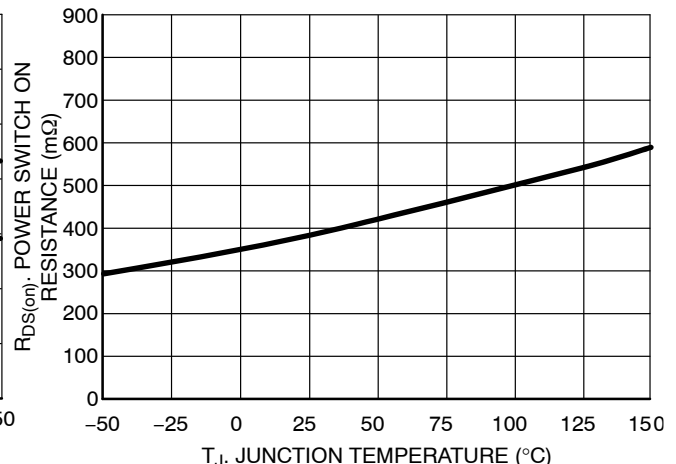

Figure 15. Power Switch  $R_{DS(on)}$  vs. Junction Temperature



TYPICAL CHARACTERISTICS CURVES



Figure 16. Minimum On Time vs. Junction Temperature



Figure 17. Minimum Off Time vs. Junction Temperature

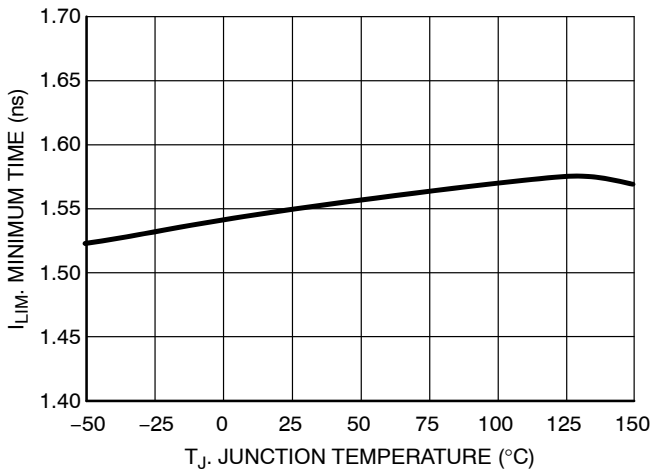

Figure 18. Current Limit Threshold vs. Junction Temperature

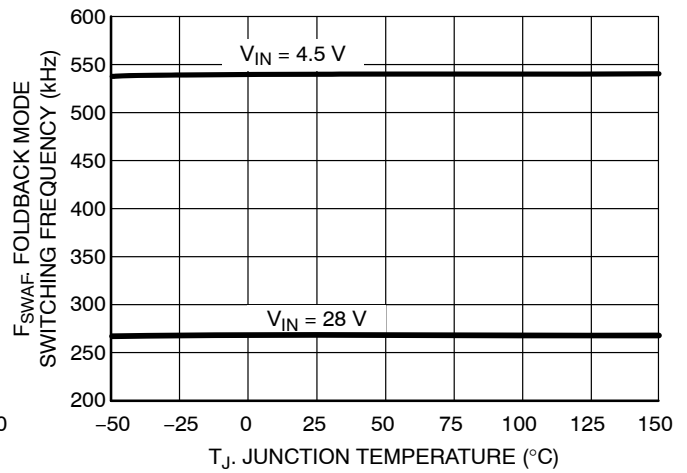

Figure 19. Short-Circuit Foldback Frequency vs. Junction Temperature

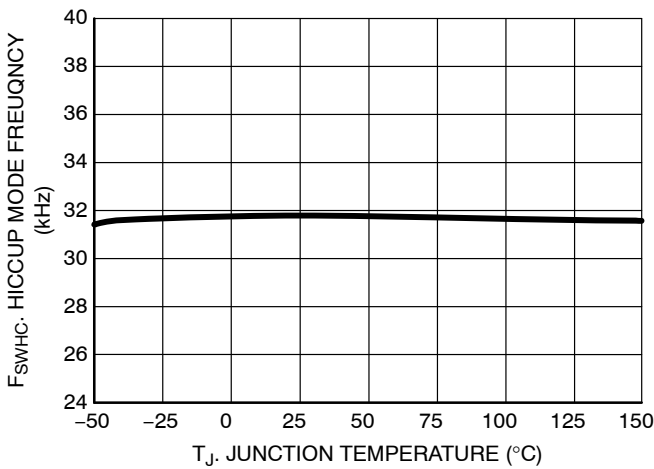

Figure 20. Hiccup Mode Switching Frequency vs. Junction Temperature



Figure 21. DRV Voltage vs. Junction Temperature

TYPICAL CHARACTERISTICS CURVES

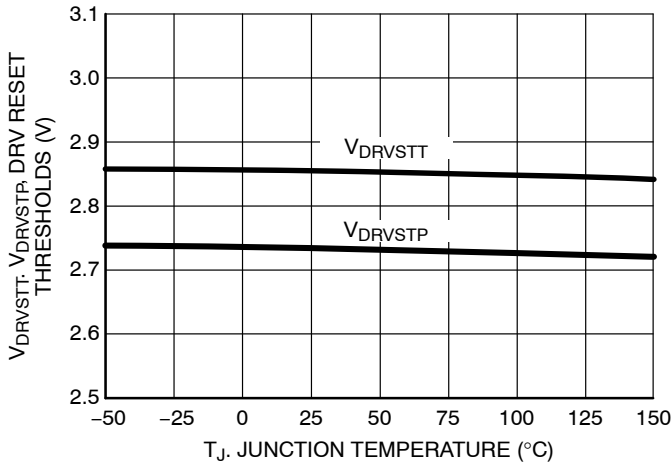

Figure 22. DRV Reset Threshold vs. Junction Temperature

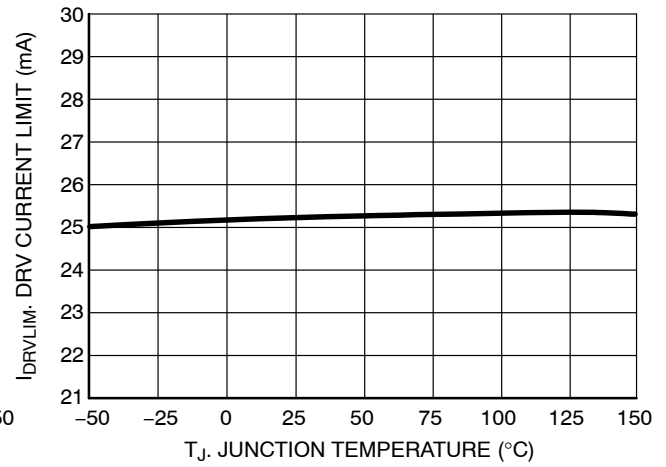

Figure 23. DRV Current Limit vs. Junction Temperature



Figure 24. Output Precharge Detector Threshold vs. Junction Temperature

GENERAL INFORMATION

INPUT VOLTAGE

An Undervoltage Lockout (UVLO) circuit monitors the input, and inhibits switching and resets the Soft-start circuit if there is insufficient voltage for proper regulation. The NCV890100 can regulate a 3.3 V output with input voltages above 4.5 V and a 5.0 V output with an input above 6.5 V.

The NCV890100 withstands input voltages up to 40 V.

To limit the power lost in generating the drive voltage for the Power Switch, the switching frequency is reduced by a factor of 2 when the input voltage exceeds the  $V_{IN}$  Frequency Foldback threshold  $V_{FLDUP}$  (see Figure 25). Frequency reduction is automatically terminated when the input voltage drops back below the  $V_{IN}$  Frequency Foldback threshold  $V_{FLDDN}$ .

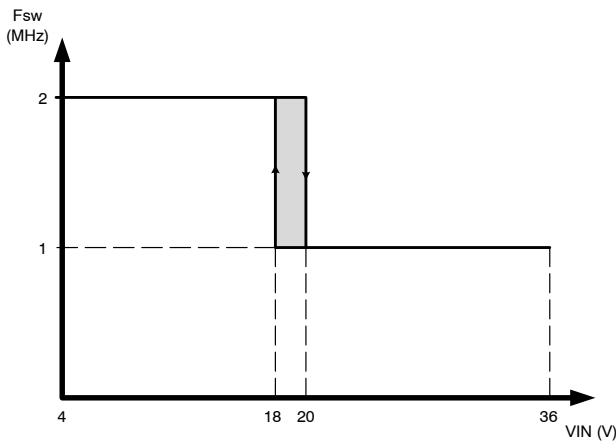

Figure 25. NCV890100 Switching Frequency Reduction at High Input Voltage

ENABLE

The NCV890100 is designed to accept either a logic level signal or battery voltage as an Enable signal. EN low induces a 'sleep mode' which shuts off the regulator and minimizes its supply current to a couple of  $\mu A$  typically ( $I_{qSD}$ ) by disabling all functions. Upon enabling, voltage is established at the DRV pin, followed by a soft-start of the switching regulator output.

SOFT-START

Upon being enabled or released from a fault condition, and after the DRV voltage is established, a soft-start circuit ramps the switching regulator error amplifier reference voltage to the final value. During soft-start, the average switching frequency is lower than its normal mode value (typically 2 MHz) until the output voltage approaches regulation.

SLOPE COMPENSATION

A fixed slope compensation signal is generated internally and added to the sensed current to avoid increased output voltage ripple due to bifurcation of inductor ripple current at duty cycles above 50%. The fixed amplitude of the slope compensation signal requires the inductor to be greater than a minimum value, depending on output voltage, in order to avoid sub-harmonic oscillations. For 3.3 V and 5 V output voltages, the recommended inductor value is 4.7  $\mu H$ .

SHORT CIRCUIT FREQUENCY FOLDBACK

During severe output overloads or short circuits, the NCV890100 automatically reduces its switching frequency. This creates duty cycles small enough to limit the peak current in the power components, while maintaining the ability to automatically reestablish the output voltage if the overload is removed. If the current is still too high after the switching frequency folds back to 500 kHz, the regulator enters an auto-recovery burst mode that further reduces the dissipated power.

CURRENT LIMITING

Due to the ripple on the inductor current, the average output current of a buck converter is lower than the peak current setpoint of the regulator. Figure 26 shows – for a 4.7  $\mu H$  inductor – how the variation of inductor peak current with input voltage affects the maximum DC current the NCV890100 can deliver to a load.

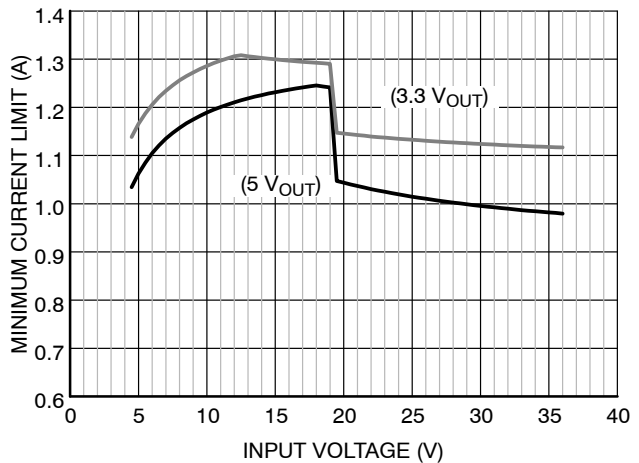
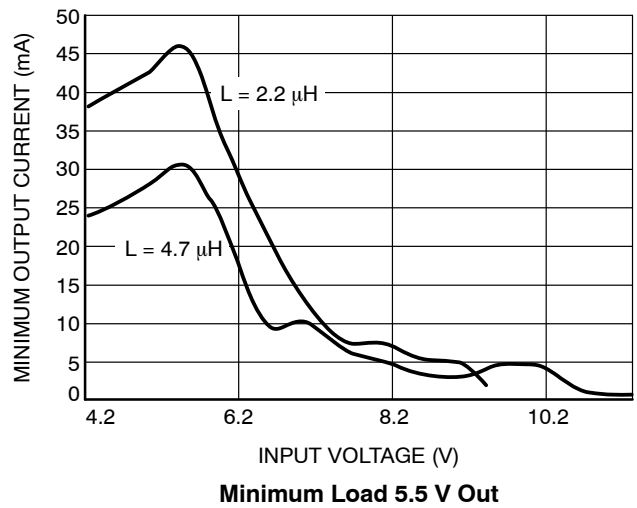
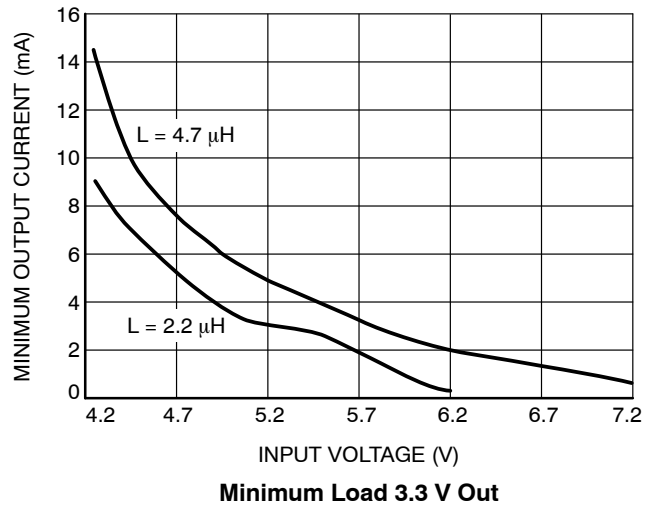
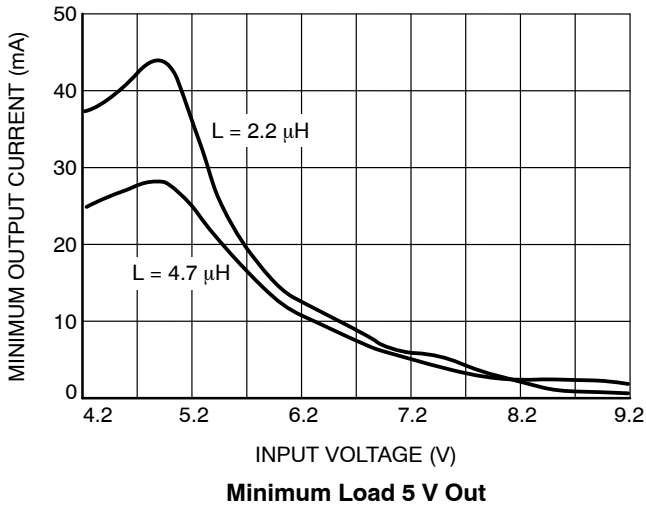

Figure 26. NCV890100 Load Current Capability with 4.7  $\mu H$  Inductor

**BOOTSTRAP**

At the DRV pin an internal regulator provides a ground-referenced voltage to an external capacitor ( $C_{DRV}$ ), to allow fast recharge of the external bootstrap capacitor ( $C_{BST}$ ) used to supply power to the power switch gate driver. If the voltage at the DRV pin goes below the DRV UVLO Threshold  $V_{DRVSTB}$  switching is inhibited and the Soft-start circuit is reset, until the DRV pin voltage goes back up above  $V_{DRVSTT}$ .

In order for the bootstrap capacitor to stay charged, the Switch node needs to be pulled down to ground regularly. In very light load condition, the NCV890100 skips switching cycles to ensure the output voltage stays regulated. When the skip cycle repetition frequency gets too low, the bootstrap voltage collapses and the regulator stops switching. Practically, this means that the NCV890100 needs a minimum load to operate correctly. Figure 27 shows the minimum current requirements for different input and output voltages.



**Figure 27. Minimum Load Current with Different Input and Output Voltages**

**OUTPUT PRECHARGE DETECTION**

Prior to Soft-start, the FB pin is monitored to ensure the SW voltage is low enough to have charged the external bootstrap capacitor (C<sub>BST</sub>). If the FB pin is higher than V<sub>SSEN</sub>, restart is delayed until the output has discharged. Figure 28 shows the IC starts to switch after the voltage on FB pin reaches V<sub>SSEN</sub>, even the EN pin is high. After the IC is switching, the FB pin follows the soft starts reference to reach the final set point.



**Figure 28. Output Voltage Detection**

**THERMAL SHUTDOWN**

A thermal shutdown circuit inhibits switching, resets the Soft-start circuit, and removes DRV voltage if internal temperature exceeds a safe level. Switching is automatically restored when temperature returns to a safe level.

**MINIMUM DROPOUT VOLTAGE**

When operating at low input voltages, two parameters play a major role in imposing a minimum voltage drop across the regulator: the minimum off time (that sets the maximum duty cycle), and the on state resistance.

When operating in continuous conduction mode (CCM), the output voltage is equal to the input voltage multiplied by the duty ratio. Because the NCV890100 needs a sufficient bootstrap voltage to operate, its duty cycle cannot be 100%: it needs a minimum off time (t<sub>OFFmin</sub>) to periodically re-fuel the bootstrap capacitor C<sub>BST</sub>. This imposes a maximum duty ratio D<sub>MAX</sub> = 1 - t<sub>OFFmin</sub>·F<sub>SW(min)</sub>, with the switching frequency being folded back down to F<sub>SW(min)</sub> = 500 kHz to keep regulating at the lowest input voltage possible.

The drop due to the on-state resistance is simply the voltage drop across the Switch resistance R<sub>DSon</sub> at the given output current: V<sub>SWdrop</sub> = I<sub>OUT</sub>·R<sub>DSon</sub>.

Which leads to the maximum output voltage in low Vin condition: V<sub>OUT</sub> = D<sub>MAX</sub>·V<sub>IN(min)</sub> - V<sub>SWdrop</sub>

**EXPOSED PAD**

The exposed pad (EPAD) on the back of the package must be electrically connected to the electrical ground (GND pin) for proper, noise-free operation.

**DESIGN METHODOLOGY**

The NCV890100 being a fixed-frequency regulator with the switching element integrated, is optimized for one value of inductor. This value is set to 4.7 μH, and the slope compensation is adjusted for this inductor. The only components left to be designed are the input and output capacitor and the freewheeling diode. Please refer to the design spreadsheet [www.onsemi.com](http://www.onsemi.com) NCV890100 page that helps with the calculation.

Output capacitor:

The minimum output capacitor value can be calculated based on the specification for output voltage ripple:

$$C_{OUTmin} = \frac{\Delta I_L}{8 \cdot \Delta V_{OUT} \cdot F_{SW}} \quad (\text{eq. 1})$$

With

- ΔI<sub>L</sub> the inductor ripple current:

$$\Delta I_L = \frac{V_{OUT} \cdot \left(1 - \frac{V_{OUT}}{V_{IN}}\right)}{L \cdot F_{SW}} \quad (\text{eq. 2})$$

- ΔV<sub>OUT</sub> the desired voltage ripple.

However, the ESR of the output capacitor also contributes to the output voltage ripple, so to comply with the requirement, the ESR cannot exceed R<sub>ESRmax</sub>:

$$R_{ESRmax} = \frac{\Delta V_{OUT} \cdot L \cdot F_{SW}}{V_{OUT} \cdot \left(1 - \frac{V_{OUT}}{V_{IN}}\right)} \quad (\text{eq. 3})$$

Finally, the output capacitor must be able to sustain the ac current (or RMS ripple current):

$$I_{OUTac} = \frac{\Delta I_L}{2\sqrt{3}} \quad (\text{eq. 4})$$

Typically, with the recommended 4.7 μH inductor, two ceramic capacitors of 10 μF each in parallel give very good results.

Freewheeling diode:

The diode must be chosen according to its maximum current and voltage ratings, and to thermal considerations.

As far as max ratings are concerned, the maximum reverse voltage the diode sees is the maximum input voltage (with some margin in case of ringing on the Switch node), and the maximum forward current the peak current limit of the NCV890100, I<sub>LIM</sub>.

The power dissipated in the diode is P<sub>Dloss</sub>:

$$P_{Dloss} = I_{OUT} \cdot \left(1 - \frac{V_{OUT}}{V_{IN}}\right) \cdot V_F + I_{DRMS} \cdot R_D \quad (\text{eq. 5})$$

with:

- $I_{OUT}$  the average (dc) output current
- $V_F$  the forward voltage of the diode
- $I_{DRMS}$  the RMS current in the diode:

$$I_{DRMS} = \sqrt{(1 - D) \left( I_{OUT}^2 + \frac{\Delta I_L^2}{12} \right)} \quad (\text{eq. 6})$$

- $R_D$  the dynamic resistance of the diode (extracted from the V/I curve of the diode in its datasheet).

Then, knowing the thermal resistance of the package and the amount of heatsinking on the PCB, the temperature rise corresponding to this power dissipation can be estimated.

Input capacitor:

The input capacitor must sustain the RMS input ripple current  $I_{INac}$ :

$$I_{INac} = \frac{\Delta I_L}{2} \sqrt{\frac{D}{3}} \quad (\text{eq. 7})$$

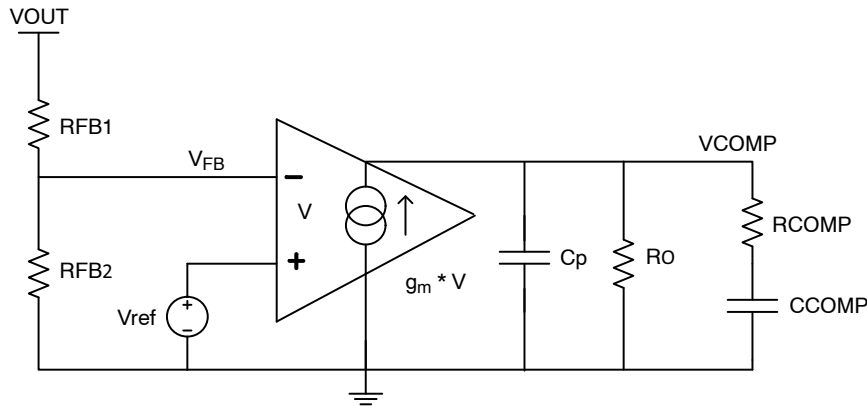

Figure 29. Feedback Compensator Network Model

The transfer function from VOUT to VCOMP is the product of the feedback voltage divider and the error amplifier.

$$G_{divider}(s) = \frac{RFB2}{RFB1 + RFB2} \quad (\text{eq. 8})$$

$$G_{err\_amp}(s) = gm \cdot Ro \cdot \frac{1 + \frac{s}{\omega_Z}}{\left(1 + \frac{s}{\omega_{pl}}\right) \left(1 + \frac{s}{\omega_{ph}}\right)} \quad (\text{eq. 9})$$

$$\omega_Z = \frac{1}{R_{COMP} \cdot C_{COMP}} \quad (\text{eq. 10})$$

$$\omega_{pl} = \frac{1}{R_o \cdot C_{COMP}} \quad (\text{eq. 11})$$

$$\omega_{ph} = \frac{1}{R_{COMP} \cdot C_p} \quad (\text{eq. 12})$$

The output resistor  $R_o$  of the error amplifier is 1.4 MΩ and  $gm$  is 1 mA/V. The capacitor  $C_p$  is for rejecting noise at high frequency and is integrated inside the IC with a value of 18 pF.

The power stage transfer function (from Vcomp to output) is shown below:

$$G_{ps}(s) = \frac{R_{load}}{R_i} \cdot \frac{1}{1 + \frac{R_{load} \cdot T_{sw}}{L} \cdot [Mc \cdot (1 - D) - 0.5]} \cdot \frac{1 + \frac{s}{\omega_Z}}{1 + \frac{s}{\omega_p}} \cdot F_h(s) \quad (\text{eq. 13})$$

$$\omega_p = \frac{1}{R_{esr} \cdot C_{out}} \quad (\text{eq. 14})$$

$$\omega_p = \frac{1}{R_{load} \cdot C_{out}} + \frac{Mc \cdot (1 - D) - 0.5}{L \cdot C_{out} \cdot F_{sw}} \quad (\text{eq. 15})$$

where

$$M_c = 1 + \frac{S_e}{S_n} \quad (\text{eq. 16})$$

$$S_n = \frac{V_{in} - V_{out}}{L} \cdot R_i \quad (\text{eq. 17})$$

$R_i$  represents the equivalent sensing resistor which has a value of  $0.29 \Omega$ ,  $S_e$  is the compensation slope which is  $291.9 \text{ kV/S}$ ,  $S_n$  is the slope of the sensing resistor current during on time.  $F_h(s)$  represents the sampling effect from the current loop which has two poles at one half of the switching frequency:

$$F_h(s) = \frac{1}{1 + \frac{s}{\omega_n \cdot Q_p} + \frac{s^2}{\omega_n^2}} \quad (\text{eq. 18})$$

$$\omega_n = \pi \cdot F_{sw}$$

$$Q_p = \frac{1}{\pi \cdot [M_c \cdot (1 - D) - 0.5]} \quad (\text{eq. 19})$$

The total loop transfer function is the product of power stage and feedback compensation network.

$$G_{loop}(s) = G_{divider}(s) \cdot G_{err\_amp}(s) \cdot G_{ps}(s) \quad (\text{eq. 20})$$

The bode plots of the open loop transfer function will show the gain and phase margin of the system. The compensation network is designed to make sure the system has enough phase margin and bandwidth.

**Design of the Compensation Network**

The function of the compensation network is to provide enough phase margin at crossover frequency to stabilize the system as well as to provide high gain at low frequency to eliminate the steady state error of the output voltage. Please refer to the design spreadsheet [www.onsemi.com](http://www.onsemi.com) NCV890100 page that helps with the calculation.

The design steps will be introduced through an example.

Example:

$V_{in} = 15.5 \text{ V}$ ,  $V_{out} = 3.3 \text{ V}$ ,  $R_{load} = 2.75 \Omega$ ,  $I_{out} = 1.2 \text{ A}$ ,  $L = 4.7 \mu\text{H}$ ,  $C_{out} = 20 \mu\text{F}$  ( $R_{esr} = 7 \text{ m}\Omega$ )

The reference voltage of the feedback signal is  $0.8 \text{ V}$  and to meet the minimum load requirements, select  $R_{FB1} = 100 \Omega$ ,  $R_{FB2} = 31.6 \Omega$ .

From the specification, the power stage transfer function can be plotted as below:

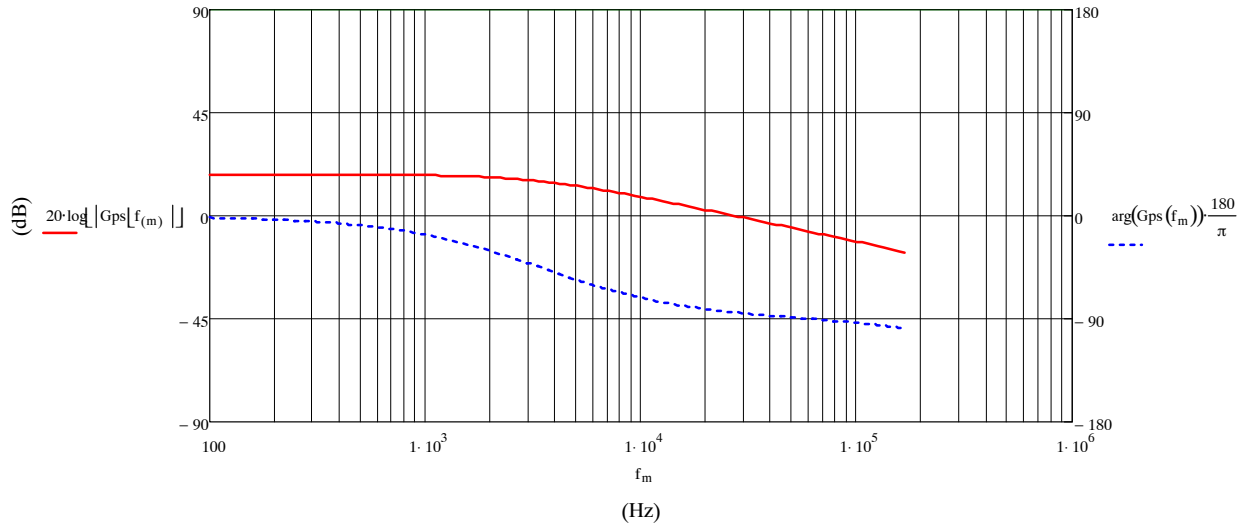

**Figure 30. Power Stage Bode Plots**

The crossover frequency is chosen to be  $F_c = 70 \text{ kHz}$ , the power stage gain at this frequency is  $-8 \text{ dB}$  ( $0.398$ ) from calculation. Then the gain of the feedback compensation network must be  $8 \text{ dB}$ . Next is to decide the locations of one zero and one pole of the compensator. The zero is to provide phase boost at the crossover frequency and the pole is to reject the noise of high frequency. In this example, a zero is placed at  $1/10$  of the crossover frequency and a pole is placed at  $1/5$  of the switching frequency ( $F_{sw} = 2 \text{ MHz}$ ):

$F_z = 7000 \text{ Hz}$ ,  $F_p = 400000 \text{ Hz}$ ,

$R_{COMP}$ ,  $C_{COMP}$  and  $C_p$  can be calculated from the following equations:

$$R_{COMP} = \frac{F_p \cdot g_m}{(F_p - F_z) \cdot |G_{ps}(F_c)|} \cdot \frac{V_{out}}{V_{ref}} \cdot \frac{\sqrt{1 + \left(\frac{F_c}{F_p}\right)^2}}{\sqrt{1 + \left(\frac{F_z}{F_c}\right)^2}} \quad (\text{eq. 21})$$

$$C_{COMP} = \frac{1}{2\pi \cdot F_z \cdot R_{COMP}} \quad (\text{eq. 22})$$

$$C_p = \frac{1}{2\pi \cdot F_p \cdot R_{COMP}} \quad (\text{eq. 23})$$

Note: there is an  $18 \text{ pF}$  capacitor at the output of the OTA integrated in the IC, and if a larger capacitor needs to be used, subtract this value from the calculated  $C_p$ . Figure 31 shows  $C_p$  is split into two capacitors.  $C_{int}$  is the  $18 \text{ pF}$  in the IC.  $C_{ext}$  is the extra capacitor added outside the IC.

# NCV890100

From the calculation:

$R_{COMP} = 10.6 \text{ K}\Omega$ ,  $C_{COMP} = 2 \text{ nF}$ ,  $C_p = 37 \text{ pF}$

So the feedback compensation network is as below:

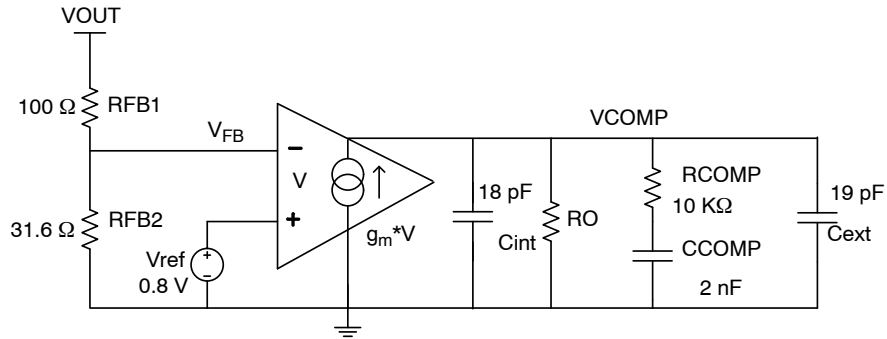

**Figure 31. Example of the Feedback Compensation Network**

Figure 32 shows the bode plot of the OTA compensator

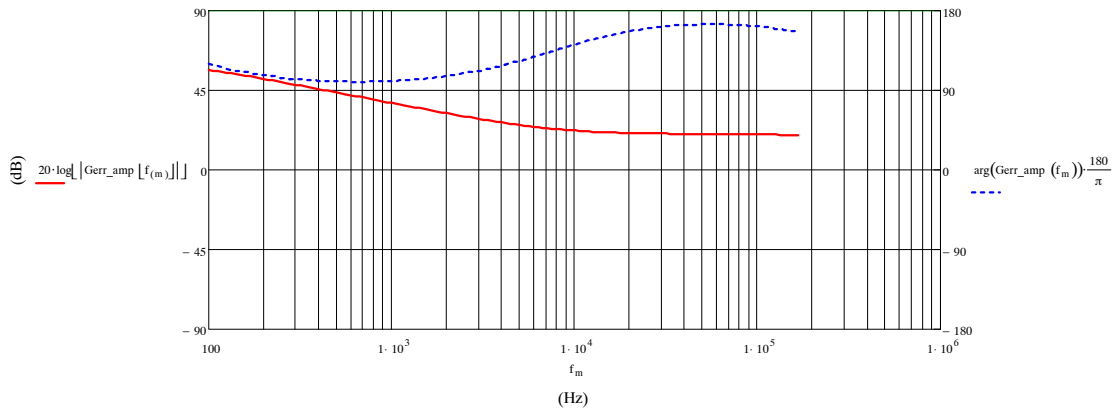

**Figure 32. Bode Plot of the OTA Compensator**

The total loop bode plot is as below:

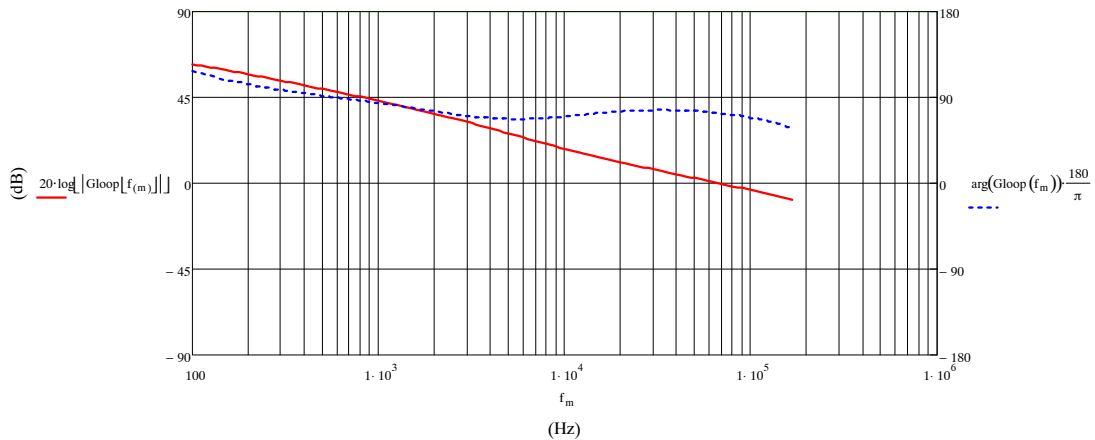

**Figure 33. Bode Plot of the Total Loop**

The crossover frequency is at 70 KHz and phase margin is 75 degrees.



# NCV890100

## PCB LAYOUT RECOMMENDATION

As with any switching power supplies, there are some guidelines to follow to optimize the layout of the printed circuit board for the NCV890100. However, because of the high switching frequency extra care has to be taken.

– Minimize the area of the power current loops:

- ◆ Input capacitor → NCV890100 switch → Inductor  
→ output capacitor → return through Ground

- ◆ Freewheeling diode → inductor → Output capacitor  
→ return through ground
- Minimize the length of high impedance signals, and route them far away from the power loops:
  - ◆ Feedback trace
  - ◆ Comp trace

## ORDERING INFORMATION

| Device         | Package                                | Shipping†          |
|----------------|--|--------------------|
| NCV890100MWTXG | DFN8 with wettable flanks<br>(Pb-Free) | 3000 / Tape & Reel |

†For information on tape and reel specifications, including part orientation and tape sizes, please refer to our Tape and Reel Packaging Specifications Brochure, BRD8011/D.

# MECHANICAL CASE OUTLINE

## PACKAGE DIMENSIONS

ON Semiconductor®



SCALE 2:1

DFN8, 3x3, 0.65P  
CASE 506BY  
ISSUE A

DATE 23 MAY 2012

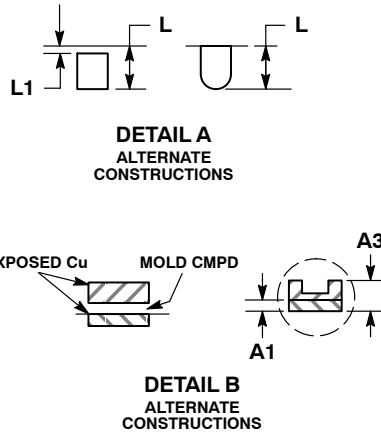
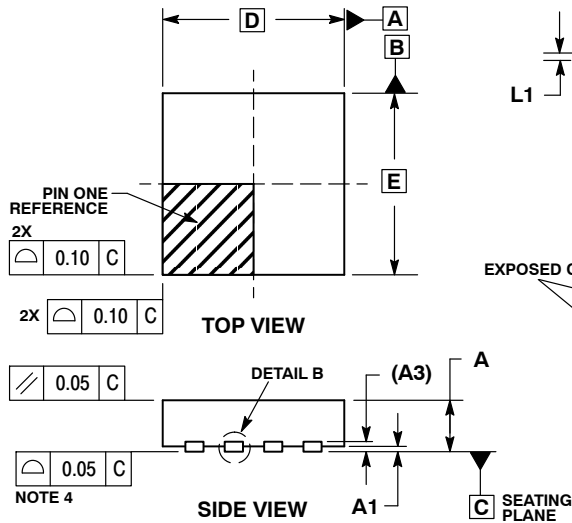

- NOTES:
1. DIMENSIONING AND TOLERANCING PER ASME Y14.5M, 1994.
  2. CONTROLLING DIMENSION: MILLIMETERS.
  3. DIMENSION b APPLIES TO PLATED TERMINAL AND IS MEASURED BETWEEN 0.15 AND 0.30mm FROM THE TERMINAL TIP.
  4. COPLANARITY APPLIES TO THE EXPOSED PAD AS WELL AS THE TERMINALS.
  5. FOR DEVICE OPN CONTAINING W OPTION, DETAIL B ALTERNATE CONSTRUCTION IS NOT APPLICABLE.

| DIM | MILLIMETERS |      |
|-----|-------------|------|
|     | MIN         | MAX  |
| A   | 0.80        | 1.00 |
| A1  | 0.00        | 0.05 |
| A3  | 0.20        | REF  |
| b   | 0.25        | 0.35 |
| D   | 3.00        | BSC  |
| D2  | 2.20        | 2.40 |
| E   | 3.00        | BSC  |
| E2  | 1.40        | 1.60 |
| e   | 0.65        | BSC  |
| K   | 0.20        | ---  |
| L   | 0.20        | 0.40 |
| L1  | 0.00        | 0.15 |

### GENERIC MARKING DIAGRAM\*

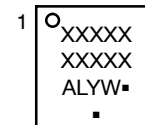

- XXXXX = Specific Device Code
- A = Assembly Location
- L = Wafer Lot
- Y = Year
- W = Work Week
- = Pb-Free Package

(Note: Microdot may be in either location)  
\*This information is generic. Please refer to device data sheet for actual part marking.  
Pb-Free indicator, "G" or microdot "▪", may or may not be present.

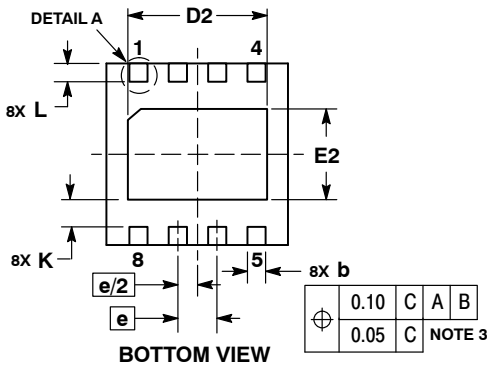

### RECOMMENDED SOLDERING FOOTPRINT\*

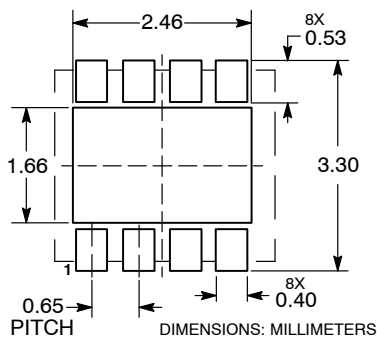

\*For additional information on our Pb-Free strategy and soldering details, please download the ON Semiconductor Soldering and Mounting Techniques Reference Manual, SOLDERRM/D.

|                  |                  |  |
|------------------|------------------|--|
| DOCUMENT NUMBER: | 98AON56369E      | Electronic versions are uncontrolled except when accessed directly from the Document Repository. Printed versions are uncontrolled except when stamped "CONTROLLED COPY" in red. |
| DESCRIPTION:     | DFN8, 3X3, 0.65P | PAGE 1 OF 1  |

ON Semiconductor and ON are trademarks of Semiconductor Components Industries, LLC dba ON Semiconductor or its subsidiaries in the United States and/or other countries. ON Semiconductor reserves the right to make changes without further notice to any products herein. ON Semiconductor makes no warranty, representation or guarantee regarding the suitability of its products for any particular purpose, nor does ON Semiconductor assume any liability arising out of the application or use of any product or circuit, and specifically disclaims any and all liability, including without limitation special, consequential or incidental damages. ON Semiconductor does not convey any license under its patent rights nor the rights of others.

**onsemi**, **Onsemi**, and other names, marks, and brands are registered and/or common law trademarks of Semiconductor Components Industries, LLC dba "**onsemi**" or its affiliates and/or subsidiaries in the United States and/or other countries. **onsemi** owns the rights to a number of patents, trademarks, copyrights, trade secrets, and other intellectual property. A listing of **onsemi**'s product/patent coverage may be accessed at [www.onsemi.com/site/pdf/Patent-Marking.pdf](http://www.onsemi.com/site/pdf/Patent-Marking.pdf). **onsemi** reserves the right to make changes at any time to any products or information herein, without notice. The information herein is provided "as-is" and **onsemi** makes no warranty, representation or guarantee regarding the accuracy of the information, product features, availability, functionality, or suitability of its products for any particular purpose, nor does **onsemi** assume any liability arising out of the application or use of any product or circuit, and specifically disclaims any and all liability, including without limitation special, consequential or incidental damages. Buyer is responsible for its products and applications using **onsemi** products, including compliance with all laws, regulations and safety requirements or standards, regardless of any support or applications information provided by **onsemi**. "Typical" parameters which may be provided in **onsemi** data sheets and/or specifications can and do vary in different applications and actual performance may vary over time. All operating parameters, including "Typicals" must be validated for each customer application by customer's technical experts. **onsemi** does not convey any license under any of its intellectual property rights nor the rights of others. **onsemi** products are not designed, intended, or authorized for use as a critical component in life support systems or any FDA Class 3 medical devices or medical devices with a same or similar classification in a foreign jurisdiction or any devices intended for implantation in the human body. Should Buyer purchase or use **onsemi** products for any such unintended or unauthorized application, Buyer shall indemnify and hold **onsemi** and its officers, employees, subsidiaries, affiliates, and distributors harmless against all claims, costs, damages, and expenses, and reasonable attorney fees arising out of, directly or indirectly, any claim of personal injury or death associated with such unintended or unauthorized use, even if such claim alleges that **onsemi** was negligent regarding the design or manufacture of the part. **onsemi** is an Equal Opportunity/Affirmative Action Employer. This literature is subject to all applicable copyright laws and is not for resale in any manner.

## ADDITIONAL INFORMATION

### TECHNICAL PUBLICATIONS:

Technical Library: [www.onsemi.com/design/resources/technical-documentation](http://www.onsemi.com/design/resources/technical-documentation)  
onsemi Website: [www.onsemi.com](http://www.onsemi.com)

### ONLINE SUPPORT: [www.onsemi.com/support](http://www.onsemi.com/support)

For additional information, please contact your local Sales Representative at [www.onsemi.com/support/sales](http://www.onsemi.com/support/sales)