

NCS2566

Six-Channel Video Driver with Triple SD & Triple Selectable SD/HD Filters

The NCS2566 integrates reconstruction filters and video amplifiers. It's a combination of two 3-channel drivers – the first one capable to deal with Standard Definition (SD) video signals and a second one including selectable filters for either Standard or High Definition (HD) video applications. The filters implemented are 6th order Butterworth Low Pass filters particularly effective for rejecting unwanted high frequency components and assuring good linearity of the phase change over frequency with well optimized group delays.

All channels can accept DC- or AC-coupled signals; when AC-coupled the internal clamps are employed. The outputs can drive both AC- and DC-coupled 150 Ω loads.

It is designed to be compatible with most Digital-to-Analog Converters (DAC) embedded in video processors. To further reduce power consumption, two enable pins are provided, one for each triple driver. One pin allows selection of the filter frequency of the SD/HD triple driver.

Features

- 3-Channel with Selectable 6th-Order 8/34 MHz Butterworth Filters
- 3-Channel with Fixed 6th-Order 8 MHz Butterworth Filters
- Transparent Input Clamp for Each Channel
- Integrated Level Shifter
- AC- or DC-Coupled Inputs and Outputs
- Low Quiescent Current
- Shutdown Current 42 μ A Typical (Disabled)
- 5 V Power Supply
- Each Channel Capable to Drive 2 by 150 Ω Load
- Internal Gain: 6 dB \pm 0.2
- Wide Input Common Mode Range
- 8 kV ESD Protection (IEC61000-4-2 Compatible)
- Operating Temperature Range: -40°C to +85°C
- Available in a TSSOP-20 Package
- These are Pb-Free Devices

Typical Applications

- Set-Top Box
- DVD players and related
- HDTV



ON Semiconductor®

<http://onsemi.com>

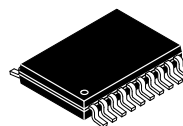

TSSOP-20
DTB SUFFIX
CASE 948E

MARKING DIAGRAM

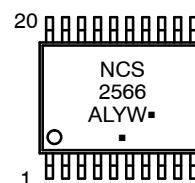

A = Assembly Location
L = Wafer Lot
Y = Year
W = Work Week
■ = Pb-Free Package

(Note: Microdot may be in either location)

PIN CONNECTIONS

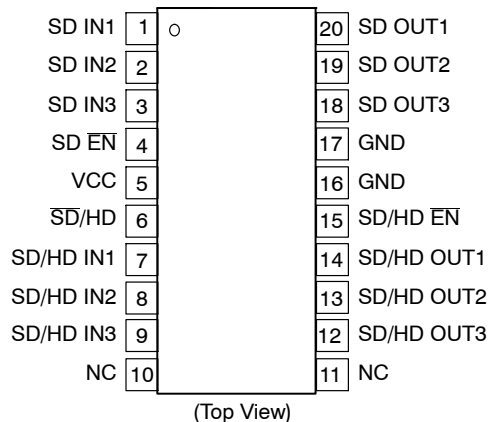

ORDERING INFORMATION

See detailed ordering and shipping information in the package dimensions section on page 12 of this data sheet.

NCS2566

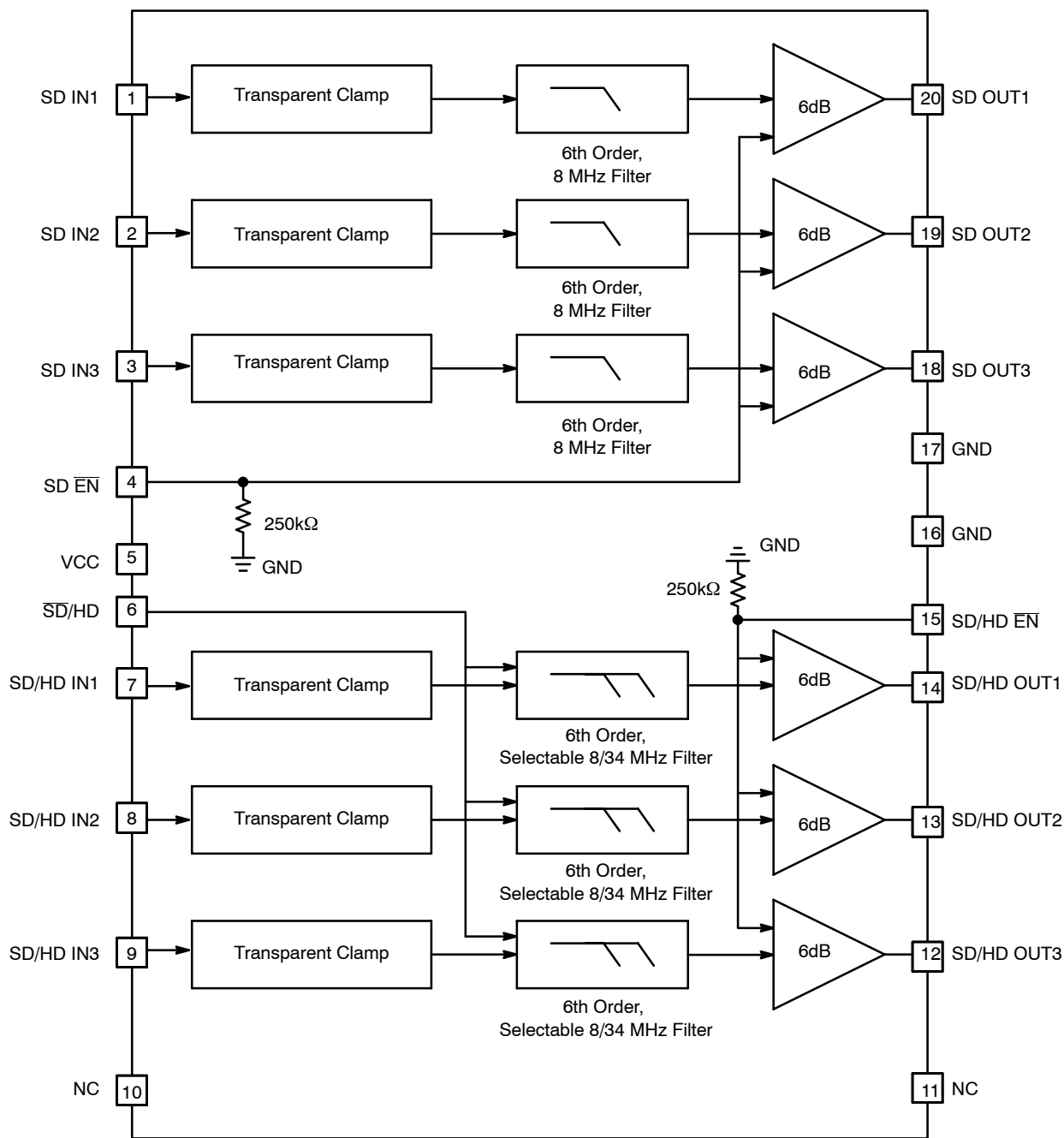

Figure 1. NCS2566 Block Diagram

NCS2566

PIN FUNCTION AND DESCRIPTION

Pin	Name	Type	Description
1	SD IN1	Input	SD Video Input 1 – SD Channel 1
2	SD IN2	Input	SD Video Input 2 – SD Channel 2
3	SD IN3	Input	SD Video Input 3 – SD Channel 3
4	SD $\overline{\text{EN}}$	Input	SD-Channel Enable/Disable Function: Low = Enable, High = Disable. When left open the default state is Enable.
5	VCC	Power	Device Power Supply Voltage: +5 V \pm 5%
6	SD/HD	Input	Pin of selection enabling the Standard Definition or High Definition Filters (8 MHz / 34 MHz) for channels SD/HD (pins 7–14, 8–13 & 9–12) – when Low SD filters are selected, when High HD filters are selected.
7	SD/HD IN1	Input	Selectable SD or HD Video Input 1 – SD/HD Channel 1
8	SD/HD IN2	Input	Selectable SD or HD Video Input 2 – SD/HD Channel 2
9	SD/HD IN3	Input	Selectable SD or HD Video Input 3 – SD/HD Channel 3
10	NC	Open	Not Connected
11	NC	Open	Not Connected
12	SD/HD OUT3	Output	SD/HD Video Output 3 – SD/HD Channel 3
13	SD/HD OUT2	Output	SD/HD Video Output 2 – SD/HD Channel 2
14	SD/HD OUT1	Output	SD/HD Video Output 1 – SD/HD Channel 1
15	SD/HD $\overline{\text{EN}}$	Input	SD/HD Channel Enable /Disable Function: Low = Enable, High = Disable. When left open the default state is Enable.
16	GND	GND	Connected to Ground
17	GND	GND	Connected to Ground
18	SD OUT3	Output	SD Video Output 3 – SD Channel 3
19	SD OUT2	Output	SD Video Output 2 – SD Channel 2
20	SD OUT1	Output	SD Video Output 1 – SD Channel 1

MAXIMUM RATINGS

Parameter	Symbol	Rating	Unit
Power Supply Voltages	V_{CC}	$-0.3 \leq V_{CC} \leq 5.5$	Vdc
Input Voltage Range	V_I	$-0.3 \leq V_I \leq V_{CC}$	Vdc
Input Differential Voltage Range	V_{ID}	$-0.3 \leq V_I \leq V_{CC}$	Vdc
Output Current Per Channel	I_O	50	mA
Maximum Junction Temperature (Note 1)	T_J	150	°C
Operating Ambient Temperature	T_A	-40 to +85	°C
Storage Temperature Range	T_{stg}	-60 to +150	°C
Power Dissipation	P_D	(See Graph)	mW
Thermal Resistance, Junction-to-Air	$R_{\theta JA}$	125	°C/W
ESD Protection Voltage (IEC61000-4-2)	V_{esd}	>8000	V
ESD HBM – Human Body Model	HBM	4000	V

Stresses exceeding Maximum Ratings may damage the device. Maximum Ratings are stress ratings only. Functional operation above the Recommended Operating Conditions is not implied. Extended exposure to stresses above the Recommended Operating Conditions may affect device reliability.

1. Power dissipation must be considered to ensure maximum junction temperature (T_J) is not exceeded.

MAXIMUM POWER DISSIPATION

The maximum power that can be safely dissipated is limited by the associated rise in junction temperature. For the plastic packages, the maximum safe junction temperature is 150°C. If the maximum is exceeded momentarily, proper circuit operation will be restored as soon as the die temperature is reduced. Leaving the device in the “overheated” condition for an extended period can result in device burnout. To ensure proper operation, it is important to observe the derating curves.

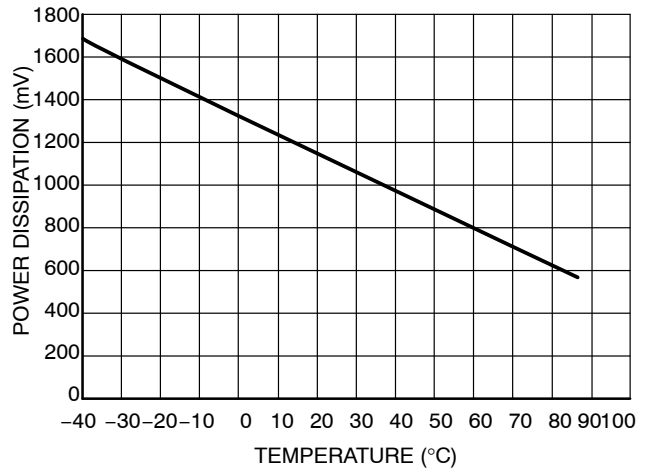

Figure 2. Power Dissipation vs Temperature

NCS2566

DC ELECTRICAL CHARACTERISTICS ($V_{CC} = +5.0\text{ V}$, $R_{source} = 37.5\ \Omega$, $T_A = 25^\circ\text{C}$, inputs AC-coupled with $0.1\ \mu\text{F}$, all outputs AC-coupled with $220\ \mu\text{F}$ into $150\ \Omega$ referenced to $400\ \text{kHz}$; unless otherwise specified)

Symbol	Characteristics	Conditions	Min	Typ	Max	Unit
POWER SUPPLY						
V_{CC}	Supply Voltage Range		4.7	5.0	5.3	V
I_{CC}	Supply Current	3 SD Channels Active 3 HD Channels Active 3 SD + 3 SD Channels Active 3 SD + 3 HD Channels Active		25 40 50 65	80	mA
I_{SD}	Shutdown Current	No Channel Active		42	80	μA

DC PERFORMANCE

V_i	Input Common Mode Voltage Range		GND		1.4	V_{PP}
V_{IL}	$\overline{\text{SD}}/\text{HD}$ Input Low Level		0		0.8	V
V_{IH}	$\overline{\text{SD}}/\text{HD}$ Input High Level		2.4		V_{CC}	V
R_{pd}	Pulldown Resistors on Pins $\overline{\text{SD}}_{\text{EN}}$ and $\text{SD}/\text{HD}_{\text{EN}}$			250		$\text{k}\Omega$

OUTPUT CHARACTERISTICS

V_{OH}	Output Voltage High Level			2.8		V
V_{OL}	Output Voltage Low Level			200		mV
I_O	Output Current			40		mA

AC ELECTRICAL CHARACTERISTICS FOR STANDARD DEFINITION CHANNELS (Pin Numbers (1, 20) (2, 19), (3, 18), (7, 14), (8, 13) & (9, 12)) ($V_{CC} = +5.0\text{ V}$, $V_{in} = 1\ V_{PP}$, $R_{source} = 37.5\ \Omega$, $T_A = 25^\circ\text{C}$, Inputs AC-coupled with $0.1\ \mu\text{F}$, All Outputs AC-coupled with $220\ \mu\text{F}$ into $150\ \Omega$ Referenced to $400\ \text{kHz}$; unless otherwise specified, $\overline{\text{SD}}/\text{HD} = \text{Low}$)

Symbol	Characteristics	Conditions	Min	Typ	Max	Unit
A_{VSD}	Voltage Gain	$V_{in} = 1\ \text{V}$ - All SD Channels	5.8	6.0	6.2	dB
BW_{SD}	Low Pass Filter Bandwidth (Note 3)	-1 dB -3 dB	5.5 6.5	7.2 8.0		MHz
A_{RSD}	Stop-Band Attenuation (Note 4)	@ 27 MHz	43	50		dB
dG_{SD}	Differential Gain Error			0.7		%
$d\Phi_{SD}$	Differential Phase Error			0.7		$^\circ$
THD	Total Harmonic Distortion	$V_{out} = 1.4\ V_{PP}$ @ 3.58 MHz		0.35		%
X_{SD}	Channel-to-Channel Crosstalk	@ 1 MHz & $V_{in} = 1.4\ V_{PP}$		-58		dB
SNR_{SD}	Signal-to-Noise Ratio	NTC-7 test signal, 100 kHz to 4.2 MHz (Note 2)		72		dB
Δt_{SD}	Propagation Delay	@ 4.5 MHz		70		ns
ΔGD_{SD}	Group Delay variation	100 kHz to 8 MHz		20		ns

2. $SNR = 20 \times \log(714\ \text{mV/RMS Noise})$
3. 100% of Tested ICs fit the bandwidth and attenuation tolerance at 25°C .
4. Guaranteed by Characterization.

NCS2566

AC ELECTRICAL CHARACTERISTICS FOR HIGH DEFINITION CHANNELS (Pin Numbers (7, 14), (8, 13) & (9, 12)) (V_{CC} = +5.0 V, V_{in} = 1 V_{PP}, R_{source} = 37.5 Ω , T_A = 25°C, Inputs AC-coupled with 0.1 μ F, All Outputs AC-coupled with 220 μ F into 150 Ω Referenced to 400 kHz; unless otherwise specified, \overline{SD}/HD = High)

Symbol	Characteristics	Conditions	Min	Typ	Max	Unit
A_{VHD}	Voltage Gain	$V_{in} = 1$ V – All HD Channels	5.8	6.0	6.2	dB
BW_{HD}	Low Pass Filter Bandwidth	-1 dB (Note 6) -3 dB (Note 7)	26 30	31 34		MHz
A_{RHD}	Stop-band Attenuation	@ 44.25 MHz (Note 7) @ 74.25 MHz (Note 6)	33	15 42		dB
THD_{HD}	Total Harmonic Distortion	$V_{out} = 1.4$ V _{PP} @ 10 MHz $V_{out} = 1.4$ V _{PP} @ 15 MHz $V_{out} = 1.4$ V _{PP} @ 22 MHz		0.4 0.6 0.8		%
X_{HD}	Channel-to-Channel Crosstalk	@ 1 MHz & $V_{in} = 1.4$ V _{PP}		-58		dB
SNR_{HD}	Signal-to-Noise Ratio	white signal, 100 kHz to 30 MHz, (Note 5)		72		dB
Δt_{HD}	Propagation Delay			25		ns
ΔGD_{HD}	Group Delay Variation from	100 kHz to 30 MHz		6.0		ns

5. $SNR = 20 \times \log(714 \text{ mV/RMS Noise})$

6. Guaranteed by characterization.

7. 100% of tested ICs fit the bandwidth and attenuation tolerance at 25°C.

TYPICAL CHARACTERISTICS

$V_{CC} = +5.0\text{ V}$, $V_{in} = 1\text{ V}_{PP}$, $R_{source} = 37.5\ \Omega$, $T_A = 25^\circ\text{C}$, Inputs AC-coupled with $0.1\ \mu\text{F}$, All Outputs AC-coupled with $220\ \mu\text{F}$ into $150\ \Omega$
 Referred to 400 kHz; unless otherwise specified

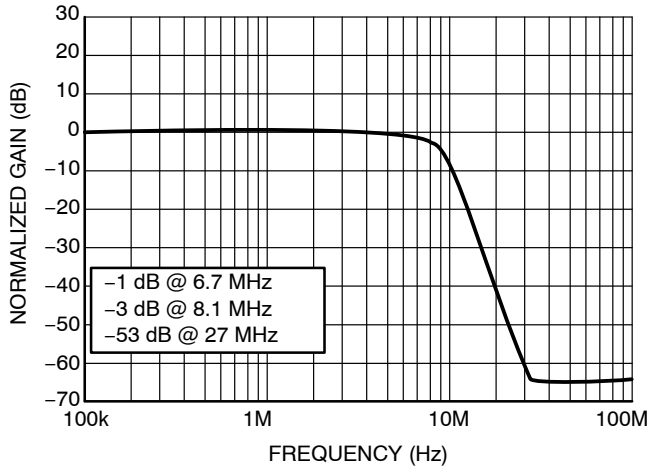

Figure 3. SD Normalized Frequency Response

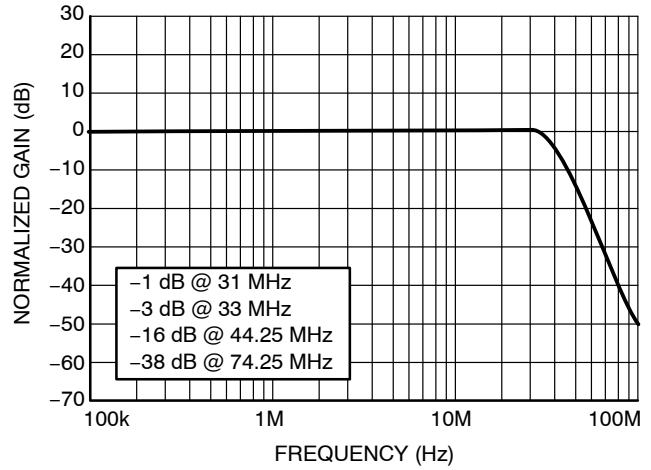

Figure 4. HD Normalized Frequency Response

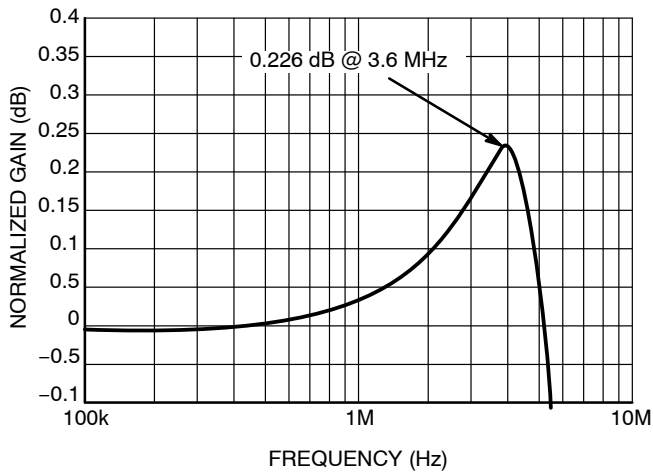

Figure 5. SD Passband Flatness

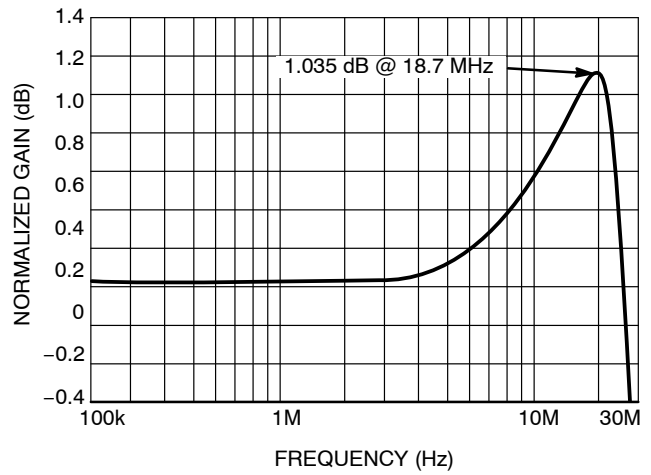

Figure 6. HD Passband Flatness

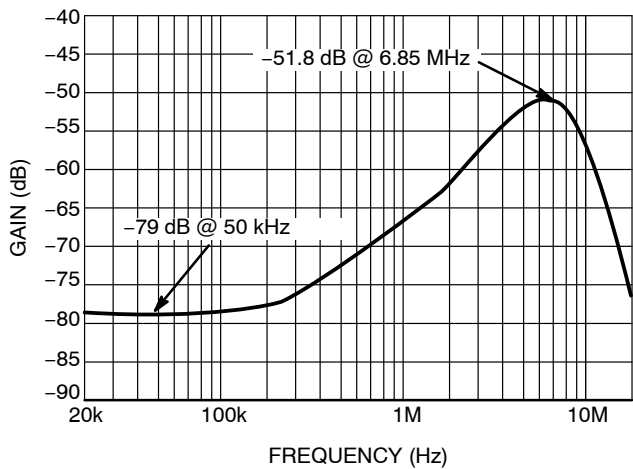

Figure 7. SD Channel-to-Channel Crosstalk

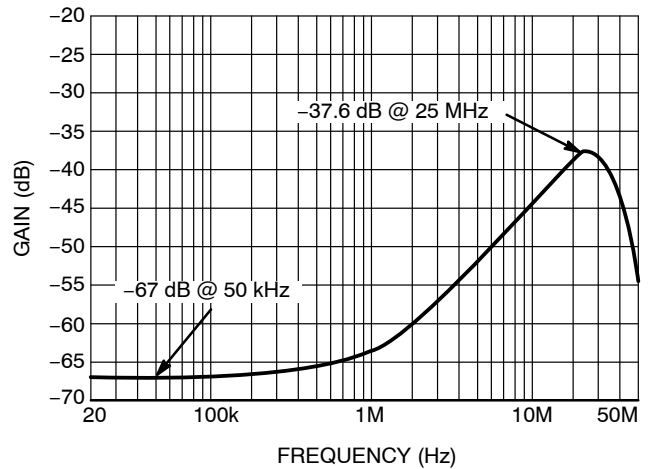

Figure 8. HD Channel-to-Channel Crosstalk

TYPICAL CHARACTERISTICS

$V_{CC} = +5.0\text{ V}$, $V_{in} = 1\text{ V}_{PP}$, $R_{source} = 37.5\ \Omega$, $T_A = 25^\circ\text{C}$, Inputs AC-coupled with $0.1\ \mu\text{F}$, All Outputs AC-coupled with $220\ \mu\text{F}$ into $150\ \Omega$
 Referred to 400 kHz; unless otherwise specified

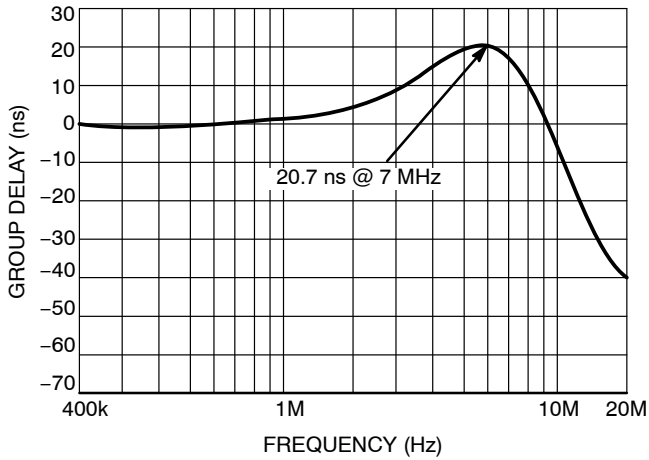

Figure 9. SD Normalized Group Delay

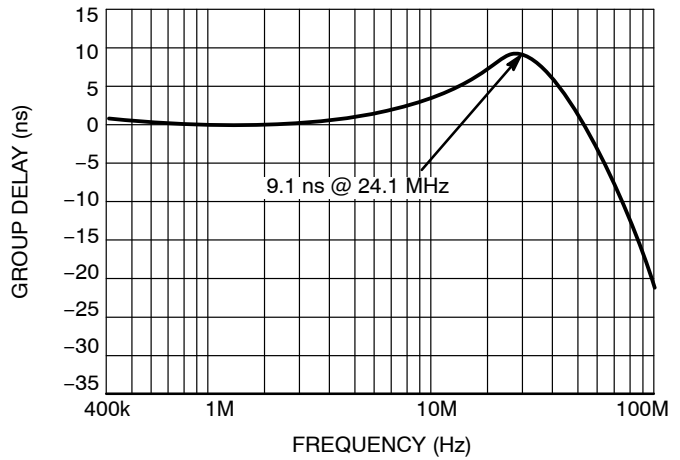

Figure 10. HD Normalized Group Delay

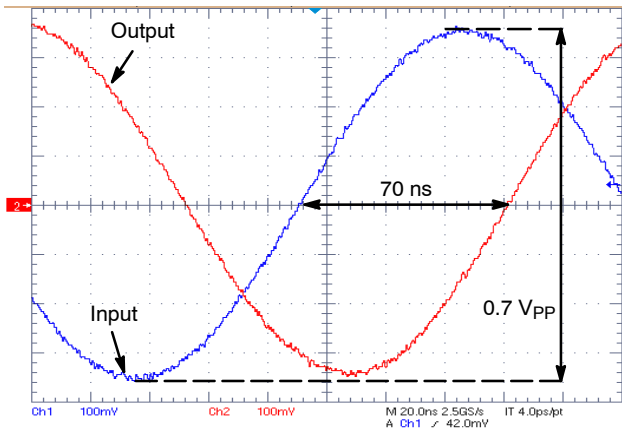

Figure 11. SD Propagation Delay

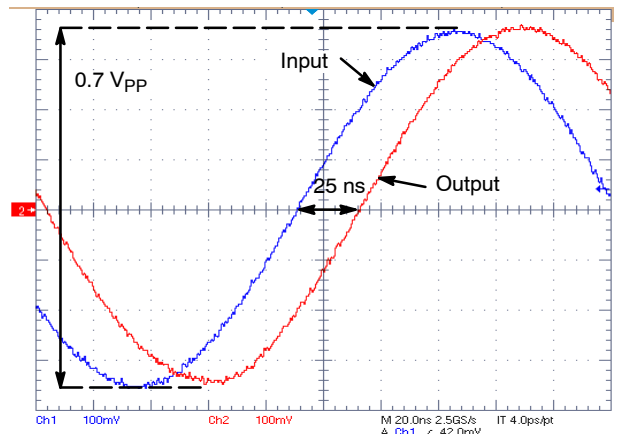

Figure 12. HD Propagation Delay

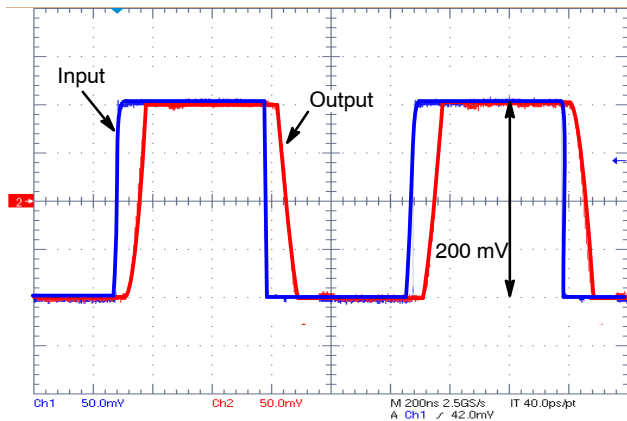

Figure 13. SD Small Signal Response

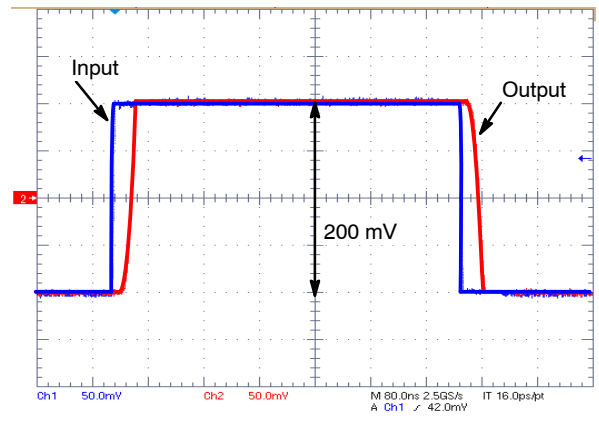

Figure 14. HD Small Signal Response

NCS2566

TYPICAL CHARACTERISTICS

$V_{CC} = +5.0\text{ V}$, $V_{in} = 1\text{ V}_{PP}$, $R_{source} = 37.5\ \Omega$, $T_A = 25^\circ\text{C}$, Inputs AC-coupled with $0.1\ \mu\text{F}$, All Outputs AC-coupled with $220\ \mu\text{F}$ into $150\ \Omega$
Referenced to 400 kHz; unless otherwise specified

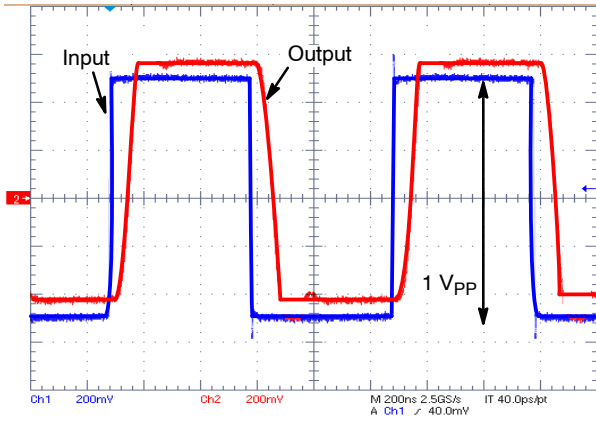

Figure 15. SD Large Signal Response

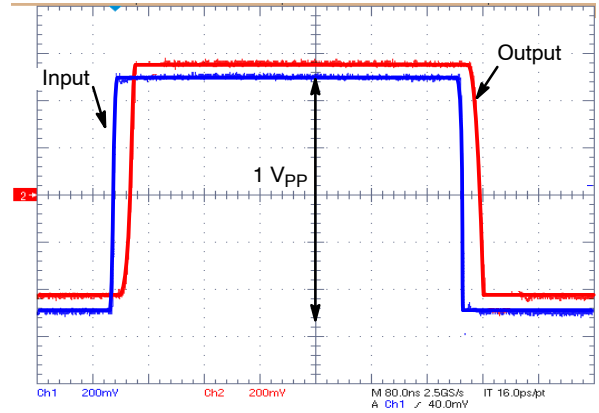

Figure 16. HD Large Signal Response

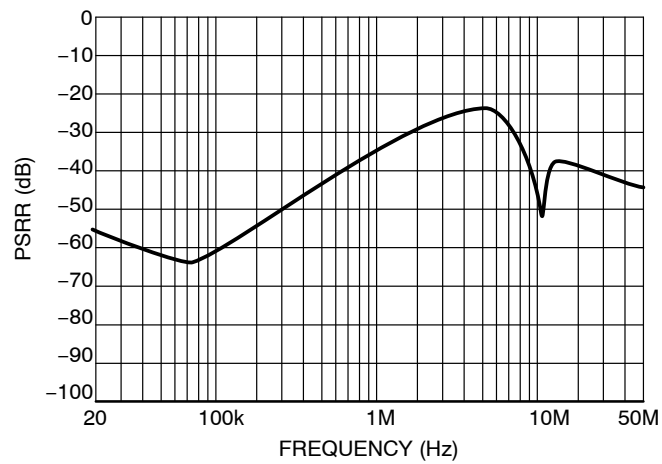

Figure 17. SD and HD V_{CC} PSRR vs. Frequency

NCS2566

TYPICAL CHARACTERISTICS

$V_{CC} = +5.0\text{ V}$, $V_{in} = 1\text{ V}_{PP}$, $R_{source} = 37.5\ \Omega$, $T_A = 25^\circ\text{C}$, Inputs AC-coupled with $0.1\ \mu\text{F}$, All Outputs AC-coupled with $220\ \mu\text{F}$ into $150\ \Omega$
 Referred to 400 kHz; unless otherwise specified

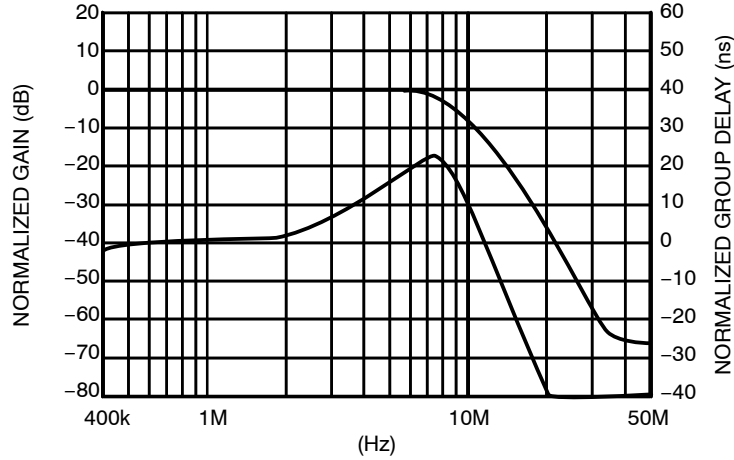

Figure 18. SD Frequency Response and Group Delay

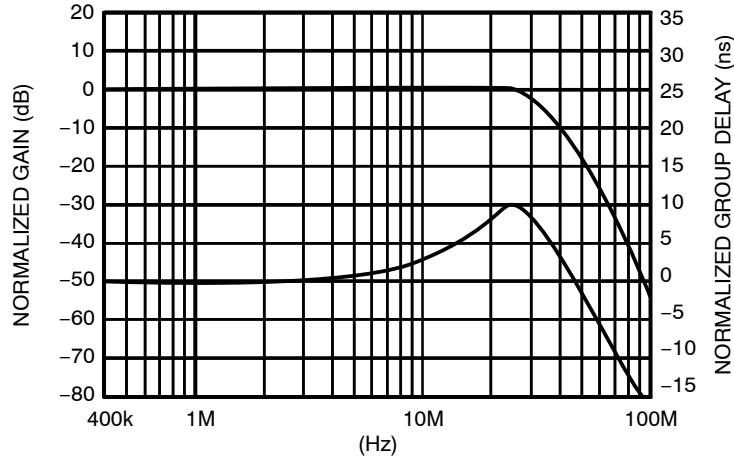

Figure 19. HD Frequency Response and Group Delay

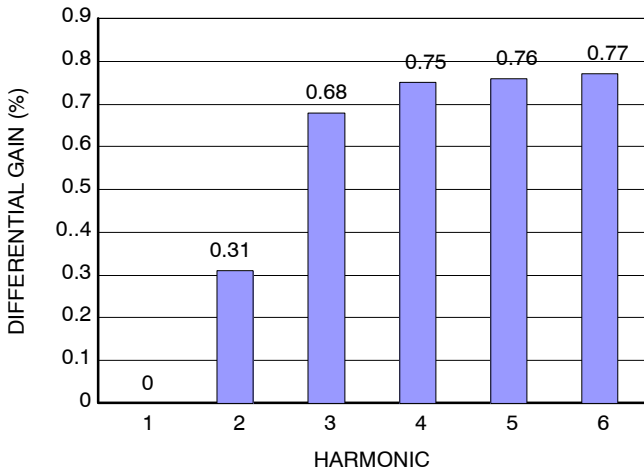

Figure 20. SD Differential Gain

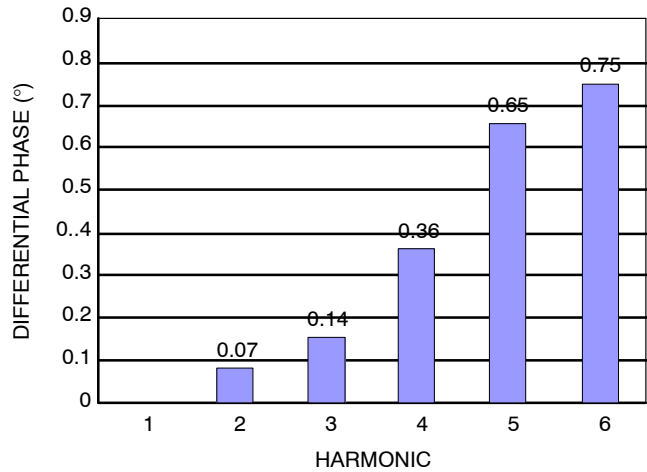

Figure 21. SD Differential Phase

APPLICATIONS INFORMATION

The NCS2566 6-channel video filter driver has been optimized for Standard and High Definition video applications covering the requirements of the standards Composite video (CVBS), S-Video, Component Video (480i/525i, 576i/625i, 720p/1080i) and related (RGB). The first 3-channels (SD1, SD2, SD3) are dedicated for Standard Definition, CVBS and S-Video applications for which the frequency bandwidth required does not exceed 8 MHz. The 3 other channels (SD/HD1, SD/HD2, SD/HD3) have selectable filters (8 MHz and 34 MHz) for covering either standard-definition-like video applications or High Definition video applications. These frequencies are selectable using the pin $\overline{SD/HD}$. If the application requires, the video driver outputs may also be disabled using the SD \overline{EN} or SD/HD \overline{EN} required by the application the pins SD \overline{EN} or SD/HD \overline{EN} .

In the regular mode of operation each channel provides an internal voltage-to-voltage gain of 2 from input to output. This effectively reduces the number of external components required as compared to discrete approaches implemented with stand-alone op amps. An internal level shifter is employed shifting up the output voltage by adding an offset of 200 mV. This prevents sync pulse clipping and allows DC-coupled output to the 150 Ω video load. In addition the NCS2566 integrates a 6th-order Butterworth filter for each channel. This allows rejection of aliases or unwanted over-sampling effects produced by the video DAC. Similar for DVD recorders which uses an ADC, this anti-aliasing filter (reconstruction filter) will avoid picture quality issues and will aide filtration of parasitic signals caused by EMI interference.

A built-in diode-like clamp is used in the chip for each channel to support the AC-coupled mode of operation. The clamp is active when the input signal goes below 0 V.

The built-in clamp and level shifter allow the device to operate in different configuration modes depending on the

DAC output signal level and the input common mode voltage of the video driver. When the configuration is DC-Coupled at the Inputs and Outputs the 0.1 μ F and 220 μ F coupling capacitors are no longer used and the clamps are in that case inactive; this configuration provides a low cost solution which can be implemented with few external components.

The input is AC-coupled when either the input-signal amplitude goes over the range 0 V to 1.4 V or if the video source requires such a coupling. In some circumstances it may be necessary to auto-bias signals with the addition of a pull-up and pull-down resistors or only pull-up resistor (Typical 7.5 M Ω combined with the internal 800 k Ω pulldown) making the clamp inactive.

The output AC-coupling configuration is advantageous for eliminating DC ground loop, but may have the drawback of increasing sensitivity to video line or field tilt issues if the output coupling capacitor is too small. DC ground loop with the drawback of making the device more sensitive to video line or field tilt issues in the case of a too low output coupling capacitor. In some cases it may be necessary to increase the nominal 220 μ F capacitor value.

All the device pins are protected against electrostatic discharge at a level of 4 kV HBM and 8 kV according to IEC61000-4-2. This feature has been considered with a particular attention with ESD structure able to sustain the typical values requested by the systems like Set Top Boxes or Blue-Ray players. This parameter is particularly important for video driver which usually constitutes the last stage in the video chain before the video output connector. The IEC61000-4-2 standard has been used to test our devices in the real application environment. Test methodology can be provided on request.

NCS2566

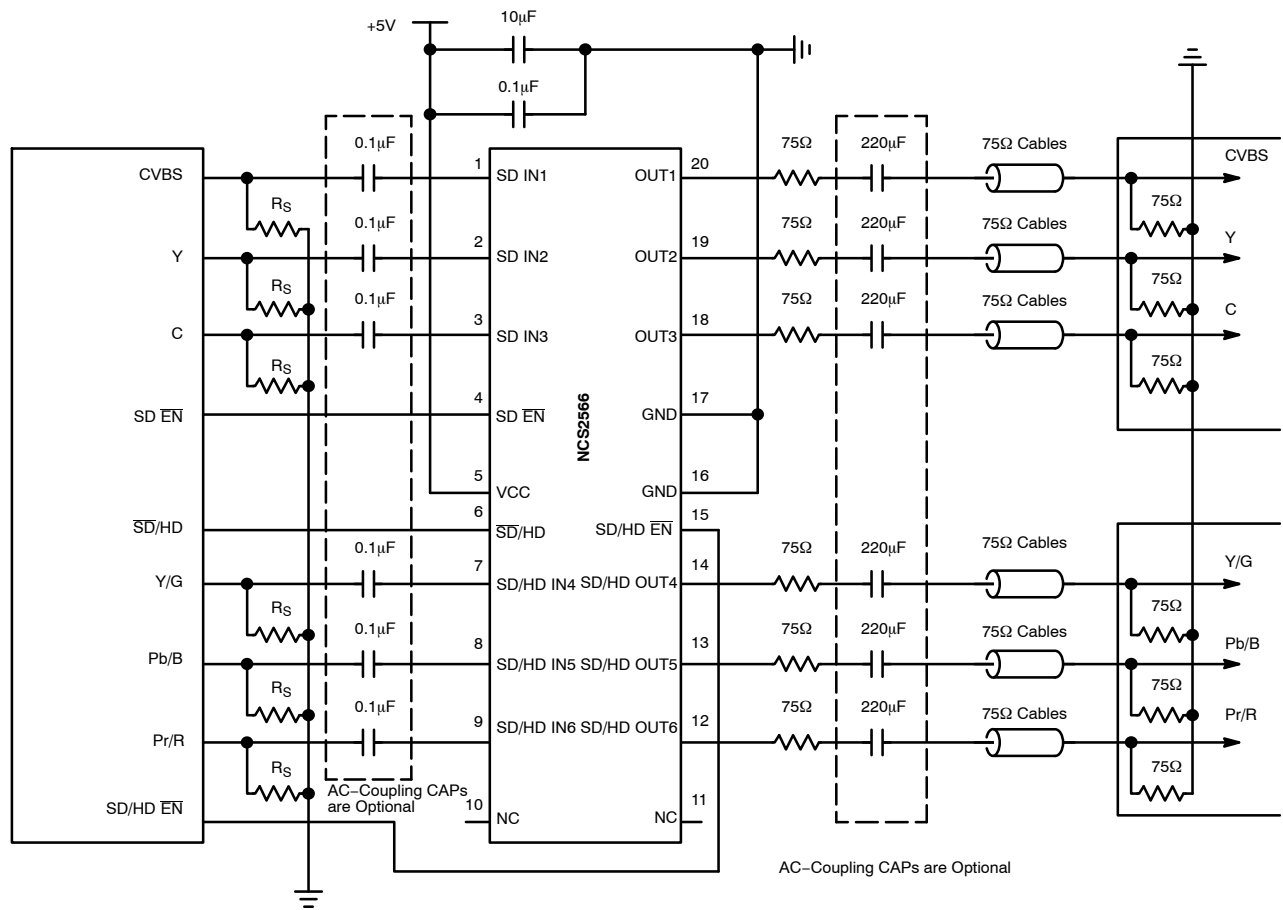

Figure 22. Typical Application

ORDERING INFORMATION

Device	Package	Shipping [†]
NCS2566DTBR2G	TSSOP-20 (Pb-Free)	2500 / Tape & Reel

[†]For information on tape and reel specifications, including part orientation and tape sizes, please refer to our Tape and Reel Packaging Specifications Brochure, BRD8011/D.

MECHANICAL CASE OUTLINE

PACKAGE DIMENSIONS

ON Semiconductor®



TSSOP-20 WB
CASE 948E
ISSUE D

DATE 17 FEB 2016

SCALE 2:1



NOTES:

1. DIMENSIONING AND TOLERANCING PER ANSI Y14.5M, 1982.
2. CONTROLLING DIMENSION: MILLIMETER.
3. DIMENSION A DOES NOT INCLUDE MOLD FLASH, PROTRUSIONS OR GATE BURRS. MOLD FLASH OR GATE BURRS SHALL NOT EXCEED 0.15 (0.006) PER SIDE.
4. DIMENSION B DOES NOT INCLUDE INTERLEAD FLASH OR PROTRUSION. INTERLEAD FLASH OR PROTRUSION SHALL NOT EXCEED 0.25 (0.010) PER SIDE.
5. DIMENSION K DOES NOT INCLUDE DAMBAR PROTRUSION. ALLOWABLE DAMBAR PROTRUSION SHALL BE 0.08 (0.003) TOTAL IN EXCESS OF THE K DIMENSION AT MAXIMUM MATERIAL CONDITION.
6. TERMINAL NUMBERS ARE SHOWN FOR REFERENCE ONLY.
7. DIMENSION A AND B ARE TO BE DETERMINED AT DATUM PLANE -W-.

DIM	MILLIMETERS		INCHES	
	MIN	MAX	MIN	MAX
A	6.40	6.60	0.252	0.260
B	4.30	4.50	0.169	0.177
C	---	1.20	---	0.047
D	0.05	0.15	0.002	0.006
F	0.50	0.75	0.020	0.030
G	0.65 BSC		0.026 BSC	
H	0.27	0.37	0.011	0.015
J	0.09	0.20	0.004	0.008
J1	0.09	0.16	0.004	0.006
K	0.19	0.30	0.007	0.012
K1	0.19	0.25	0.007	0.010
L	6.40 BSC		0.252 BSC	
M	0°	8°	0°	8°

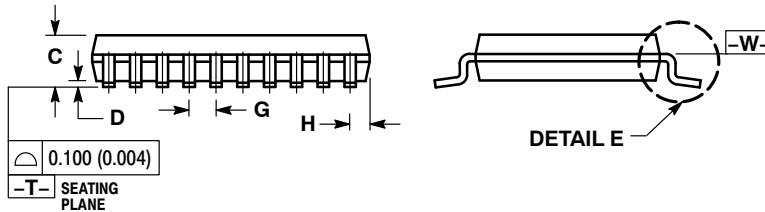

SOLDERING FOOTPRINT

GENERIC MARKING DIAGRAM*

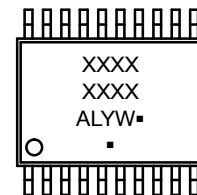

- A = Assembly Location
- L = Wafer Lot
- Y = Year
- W = Work Week
- = Pb-Free Package

(Note: Microdot may be in either location)

*This information is generic. Please refer to device data sheet for actual part marking. Pb-Free indicator, "G" or microdot "▪", may or may not be present.

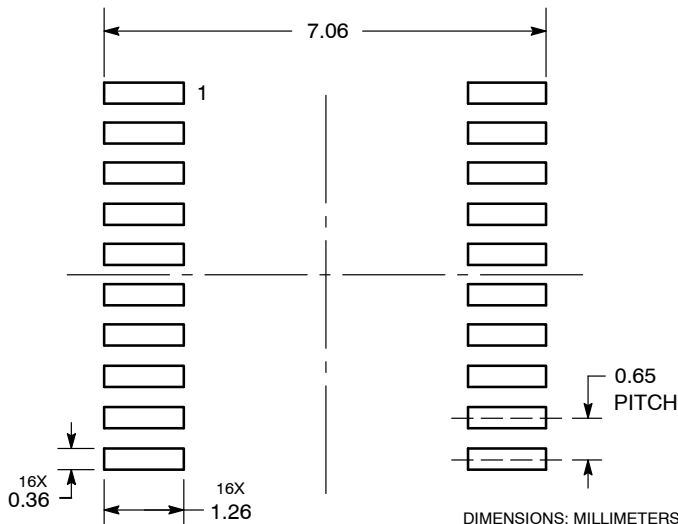

DIMENSIONS: MILLIMETERS

DOCUMENT NUMBER:	98ASH70169A	Electronic versions are uncontrolled except when accessed directly from the Document Repository. Printed versions are uncontrolled except when stamped "CONTROLLED COPY" in red.
DESCRIPTION:	TSSOP-20 WB	PAGE 1 OF 1

ON Semiconductor and ON are trademarks of Semiconductor Components Industries, LLC dba ON Semiconductor or its subsidiaries in the United States and/or other countries. ON Semiconductor reserves the right to make changes without further notice to any products herein. ON Semiconductor makes no warranty, representation or guarantee regarding the suitability of its products for any particular purpose, nor does ON Semiconductor assume any liability arising out of the application or use of any product or circuit, and specifically disclaims any and all liability, including without limitation special, consequential or incidental damages. ON Semiconductor does not convey any license under its patent rights nor the rights of others.

onsemi, **Onsemi**, and other names, marks, and brands are registered and/or common law trademarks of Semiconductor Components Industries, LLC dba "**onsemi**" or its affiliates and/or subsidiaries in the United States and/or other countries. **onsemi** owns the rights to a number of patents, trademarks, copyrights, trade secrets, and other intellectual property. A listing of **onsemi**'s product/patent coverage may be accessed at www.onsemi.com/site/pdf/Patent-Marking.pdf. **onsemi** reserves the right to make changes at any time to any products or information herein, without notice. The information herein is provided "as-is" and **onsemi** makes no warranty, representation or guarantee regarding the accuracy of the information, product features, availability, functionality, or suitability of its products for any particular purpose, nor does **onsemi** assume any liability arising out of the application or use of any product or circuit, and specifically disclaims any and all liability, including without limitation special, consequential or incidental damages. Buyer is responsible for its products and applications using **onsemi** products, including compliance with all laws, regulations and safety requirements or standards, regardless of any support or applications information provided by **onsemi**. "Typical" parameters which may be provided in **onsemi** data sheets and/or specifications can and do vary in different applications and actual performance may vary over time. All operating parameters, including "Typicals" must be validated for each customer application by customer's technical experts. **onsemi** does not convey any license under any of its intellectual property rights nor the rights of others. **onsemi** products are not designed, intended, or authorized for use as a critical component in life support systems or any FDA Class 3 medical devices or medical devices with a same or similar classification in a foreign jurisdiction or any devices intended for implantation in the human body. Should Buyer purchase or use **onsemi** products for any such unintended or unauthorized application, Buyer shall indemnify and hold **onsemi** and its officers, employees, subsidiaries, affiliates, and distributors harmless against all claims, costs, damages, and expenses, and reasonable attorney fees arising out of, directly or indirectly, any claim of personal injury or death associated with such unintended or unauthorized use, even if such claim alleges that **onsemi** was negligent regarding the design or manufacture of the part. **onsemi** is an Equal Opportunity/Affirmative Action Employer. This literature is subject to all applicable copyright laws and is not for resale in any manner.

ADDITIONAL INFORMATION

TECHNICAL PUBLICATIONS:

Technical Library: www.onsemi.com/design/resources/technical-documentation
onsemi Website: www.onsemi.com

ONLINE SUPPORT: www.onsemi.com/support

For additional information, please contact your local Sales Representative at www.onsemi.com/support/sales