

# NCS2300

## Headset Detection Interface

The NCS2300 is a compact and cost effective headset detection interface IC. It integrates a comparator, OR gate, and N-channel MOSFET to detect the presence of a stereo headset with a microphone. Pull-up resistors for the detection pins are internalized. A built in resistor divider provides the reference voltage for detecting the left audio channel. The logic low output of the OR gate indicates the headset has been connected properly. The NCS2300 comes in a space saving UDFN6 package (1.2 x 1.0 mm).

### Features

- Supply Voltage: 1.6 V to 2.75 V
- Low Quiescent Supply Current: 7.5  $\mu$ A typical @  $V_{DD} = 1.8$  V
- Integrated Resistors, Comparator, OR Gate, and N-Channel MOSFET
- Space Saving UDFN6 Package
- These Devices are Pb-Free, Halogen Free/BFR Free and are RoHS Compliant

### Typical Applications

- Cell Phones, Smartphones
- Tablets
- Notebooks



**ON Semiconductor**<sup>®</sup>

<http://onsemi.com>

### MARKING DIAGRAM

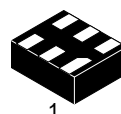

UDFN6  
MU SUFFIX  
CASE 517AA



A = Specific Device Code  
M = Date Code  
▪ = Pb-Free Package

### PIN DIAGRAM

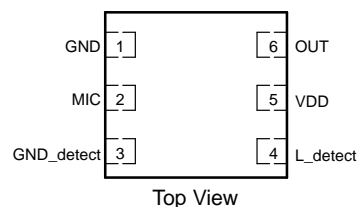

### ORDERING INFORMATION

Device	Package	Shipping <sup>†</sup>
NCS2300MUTAG	UDFN6 (Pb-Free)	3000 / Tape & Reel

<sup>†</sup>For information on tape and reel specifications, including part orientation and tape sizes, please refer to our Tape and Reel Packaging Specification Brochure, BRD8011/D.

# NCS2300

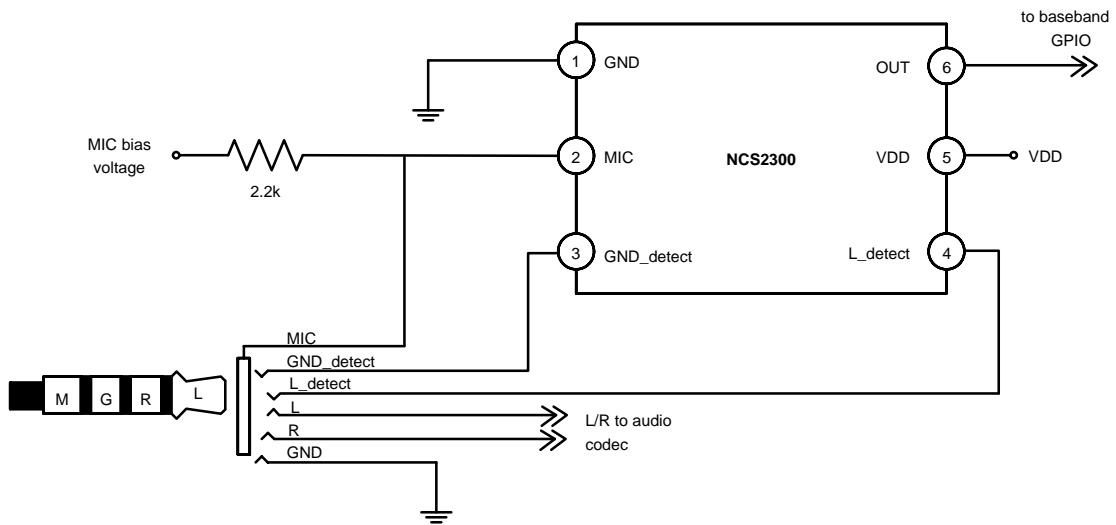

Figure 1. Typical Application Schematic

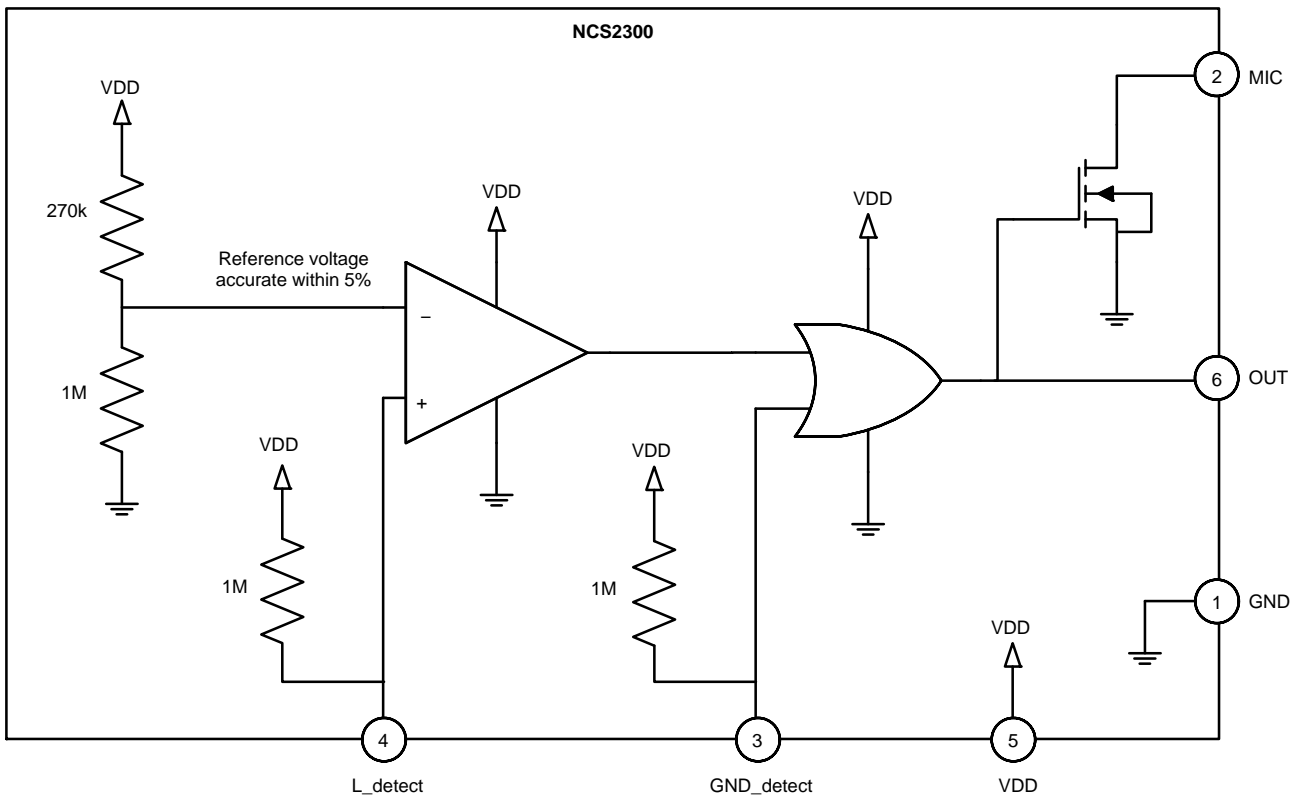

Figure 2. Block Diagram

# NCS2300

**Table 1. OUTPUT LOGIC**

Inputs		Outputs		Headset
L_detect	GND_detect	OUT	MIC	
0	0	0	1 (external pull-up)	Detected
0	1	1	0	Not Detected
1	0	1	0	
1	1	1	0	

**Table 2. PIN DESCRIPTION**

Pin	Name	Type	Description
1	GND	Power	GND is connected to the system ground.
2	MIC	Output	The open drain MIC output controls the bias on the MIC line. When the headset is not present, MIC is pulled low. When the headset is present, MIC is pulled up to the MIC bias voltage through an external pull-up resistor.
3	GND_detect	Input	GND_detect is the OR gate input. An internal 1 M $\Omega$ pull-up resistor pulls this pin high when the headset is not present.
4	L_detect	Input	L_detect is the comparator input. An internal 1 M $\Omega$ pull-up resistor pulls this pin high when the headset is not present.
5	VDD	Power	VDD is connected to the system power supply. A 0.1 $\mu$ F decoupling capacitor is recommended as close as possible to this pin.
6	OUT	Output	OUT is a logic output that indicates whether the headset has been properly connected. OUT will be logic low only when GND_detect and L_detect are low.

**Table 3. ABSOLUTE MAXIMUM RATINGS** (Note 1)

Rating	Symbol	Value	Unit
Supply Voltage Range	V <sub>DD</sub>	0 to 2.75	V
L_detect Input Pin Voltage Range	V <sub>L_detect</sub>	-0.1 to V <sub>DD</sub> + 0.1	V
GND_detect Input Pin Voltage Range	V <sub>GND_detect</sub>	-0.1 to V <sub>DD</sub> + 0.1	
MIC Output Pin Voltage Range	V <sub>MIC</sub>	0 to 6.0	V
Maximum MIC Current	I <sub>MIC</sub>	2	mA
Maximum Junction Temperature	T <sub>J(max)</sub>	+125	°C
Storage Temperature Range	T <sub>stg</sub>	-65 to +150	°C
ESD Capability (Note 2) Human Body Model Machine Model	ESD <sub>HBM</sub> ESD <sub>MM</sub>	5000 250	V
Latch-up Current (Note 3)	I <sub>LU</sub>	800	mA
Moisture Sensitivity Level (Note 4)	MSL	Level 1	

Stresses exceeding those listed in the Maximum Ratings table may damage the device. If any of these limits are exceeded, device functionality should not be assumed, damage may occur and reliability may be affected.

1. Refer to ELECTRICAL CHARACTERISTICS and APPLICATION INFORMATION for Safe Operating Area.
2. This device series incorporates ESD protection and is tested by the following methods:  
ESD Human Body Model tested per AEC-Q100-002 (JEDEC standard: JESD22-A114)  
ESD Machine Model tested per AEC-Q100-003 (JEDEC standard: JESD22-A115)
3. Latch-up Current tested per JEDEC standard: JESD78
4. Moisture Sensitivity Level tested per IPC/JEDEC standard: J-STD-020A

# NCS2300

**Table 4. OPERATING RANGES**

Rating	Conditions	Symbol	Min	Typ	Max	Unit
Power Supply Voltage		$V_{DD}$	1.6	1.8	2.75	V
Input Voltage	L_detect and GND_detect pins	$V_{IN}$	0		$V_{DD}$	V
Input Transition Rise or Fall Rate	GND_detect pin	$\Delta t / \Delta V$	0		10	ns/V
Bias Voltage on MIC Output		$V_{MIC}$	0		3.0	V
Ambient Temperature		$T_A$	-40		85	°C
Junction Temperature		$T_J$	-40		125	°C

Functional operation above the stresses listed in the Recommended Operating Ranges is not implied. Extended exposure to stresses beyond the Recommended Operating Ranges limits may affect device reliability.

**Table 5. ELECTRICAL CHARACTERISTICS** Typical values are referenced to  $T_A = 25^\circ\text{C}$ ,  $V_{DD} = 1.8\text{ V}$ , unless otherwise noted. Min/max values apply from  $T_A = -40^\circ\text{C}$  to  $85^\circ\text{C}$ , unless otherwise noted. (Note 5)

Parameter	Test Conditions	Symbol	Min	Typ	Max	Unit
-----------	-----------------	--------	-----	-----	-----	------

**SUPPLY CHARACTERISTICS**

Quiescent Supply Current	$V_{GND\_detect} = 1.8\text{ V}$ or $0\text{ V}$	$I_{DD}$		7.5	12	$\mu\text{A}$
--------------------------	--	----------	--	-----	----	---------------

**INPUT CHARACTERISTICS OF L\_DETECT**

Voltage Input Low	$V_{DD} = 1.8\text{ V}$	$V_{IL}$			1.33	V
Voltage Input High	$V_{DD} = 1.8\text{ V}$	$V_{IH}$	1.5			V
Propagation Delay to OUT	$C_{out} = 15\text{ pF}$ , $GND\_detect = 0\text{ V}$ , $L\_detect = 1.31\text{ V}$ to $1.52\text{ V}$	$t_{pLH}$ , $t_{pHL}$		480		ns
Low Voltage Input Leakage	$V_{L\_detect} = 0\text{ V}$	$I_{IL}$		1.8		$\mu\text{A}$
High Voltage Input Leakage	$V_{L\_detect} = 1.8\text{ V}$	$I_{IH}$		500		pA
Input Capacitance	$f = 1\text{ MHz}$	$C_{IN}$		3		pF

**INPUT CHARACTERISTICS OF GND\_DETECT**

Voltage Input Low	$V_{DD} = 1.8\text{ V}$	$V_{IL}$			0.63	V
Voltage Input High	$V_{DD} = 1.8\text{ V}$	$V_{IH}$	1.17			V
Propagation Delay to OUT	$C_{out} = 15\text{ pF}$ , $R_L = 1\text{ M}\Omega$ , $L\_detect = 0\text{ V}$ , $GND\_detect = 0$ to $1.8\text{ V}$	$t_{pLH}$ , $t_{pHL}$		550		ps
Low Voltage Input Leakage	$V_{GND\_detect} = 0\text{ V}$	$I_{IL}$		1.8		$\mu\text{A}$
High Voltage Input Leakage	$V_{GND\_detect} = 1.8\text{ V}$	$I_{IH}$		500		pA
Input Capacitance	$f = 1\text{ MHz}$	$C_{IN}$		3		pF

**OUTPUT CHARACTERISTICS OF OUT**

Voltage Output Low	$V_{DD} = 1.8\text{ V}$ , $I_{OH} = 0.1\text{ mA}$	$V_{OL}$			0.10	V
Voltage Output High	$V_{DD} = 1.8\text{ V}$ , $I_{OH} = -0.1\text{ mA}$	$V_{OH}$	1.70			V
Rise Time	$C_{OUT} = 15\text{ pF}$ , $R_L = 1\text{ M}\Omega$	$t_{rise}$		7		ns
Fall Time	$C_{OUT} = 15\text{ pF}$ , $R_L = 1\text{ M}\Omega$	$t_{fall}$		4		ns

**CHARACTERISTICS OF MIC**

Drain-Source On Resistance of NMOS	$V_{DD} = 1.8\text{ V}$ , $I_{MIC} = 1\text{ mA}$	$R_{DS(on)}$		0.9	1.4	$\Omega$
------------------------------------	---	--------------	--	-----	-----	----------

Product parametric performance is indicated in the Electrical Characteristics for the listed test conditions, unless otherwise noted. Product performance may not be indicated by the Electrical Characteristics if operated under different conditions.

5. Guaranteed by characterization and/or design.

TYPICAL CHARACTERISTICS

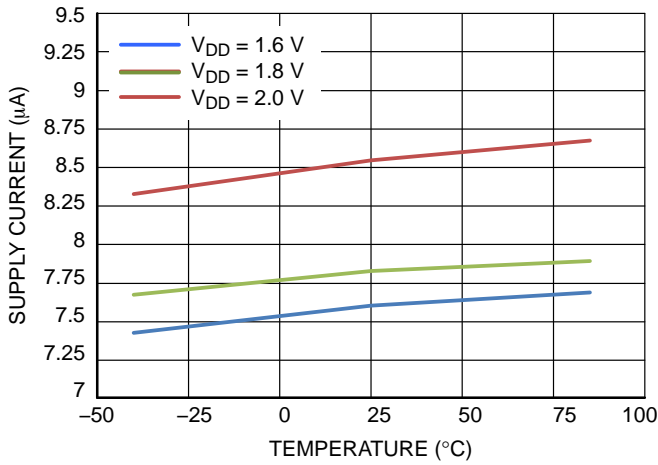

Figure 3. Supply Current vs. Temperature

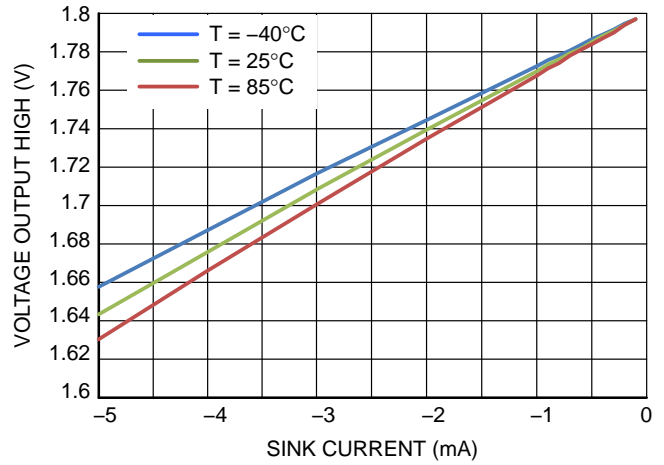

Figure 4.  $V_{OH}$  vs.  $I_{OH}$  of OUT Pin

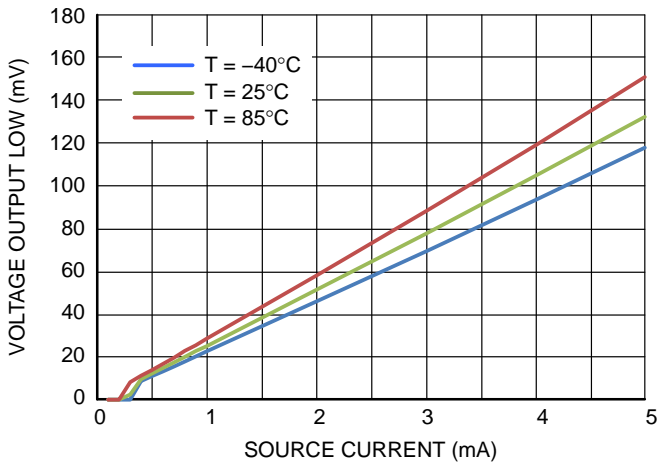

Figure 5.  $V_{OL}$  vs.  $I_{OL}$  of OUT Pin

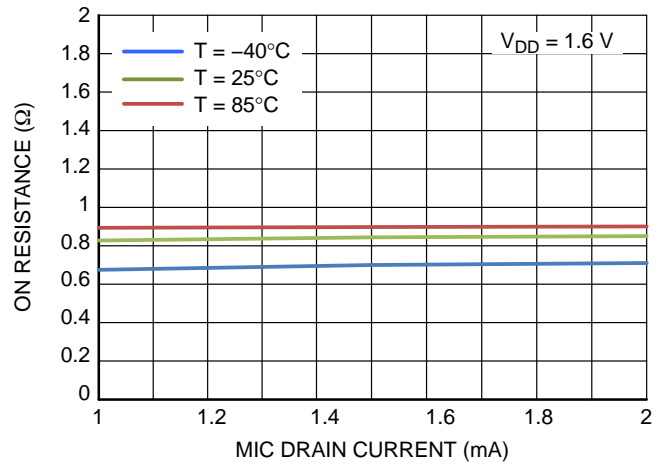

Figure 6. On Resistance vs. Drain Current at  $V_{DD} = 1.6 V$

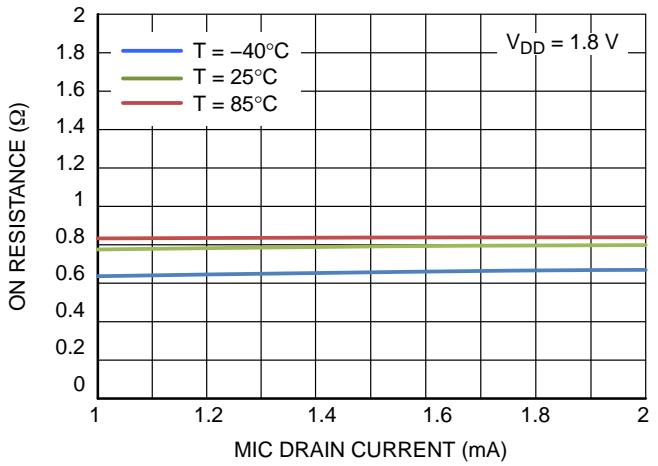

Figure 7. On Resistance vs. Drain Current at  $V_{DD} = 1.8 V$

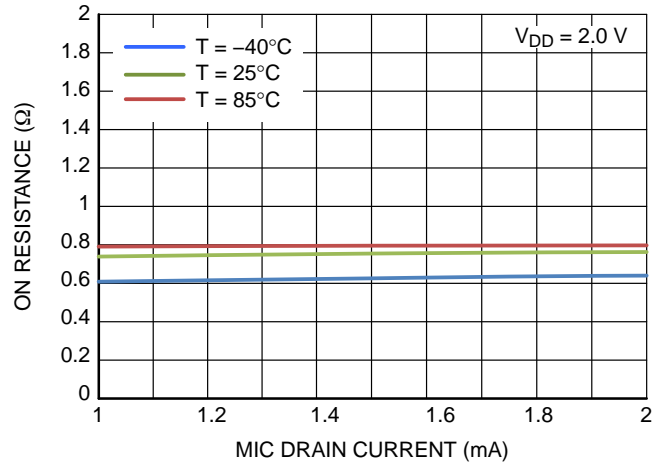

Figure 8. On Resistance vs. Drain Current at  $V_{DD} = 2.0 V$

TYPICAL CHARACTERISTICS

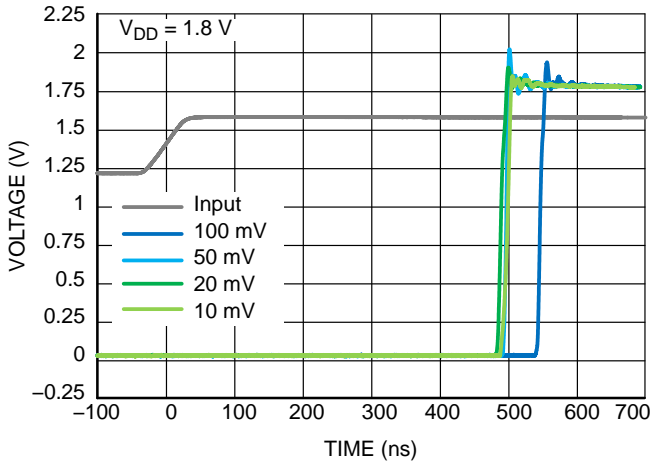

Figure 9. Low to High Propagation to OUT with Changing Input Overdrive of L\_detect

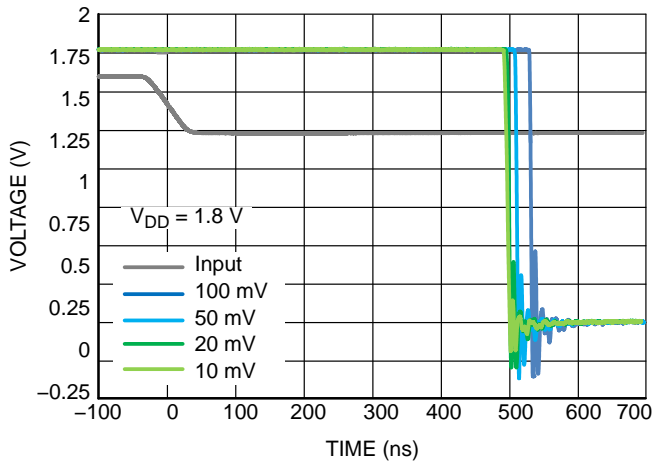

Figure 10. High to Low Propagation to OUT with Changing Input Overdrive of L\_detect

APPLICATIONS INFORMATION

**SUPPLY VOLTAGE**

The NCS2300 works with a wide range of supply voltages from 1.6 V to 2.75 V. A 0.1  $\mu$ F decoupling capacitor should be placed as close as possible to the VDD pin. Since the NCS2300 has built in latch-up immunity up to 800 mA, series resistors are not recommended on VDD.

**AUDIO JACK DETECTION**

The NCS2300 is designed to simplify the detection of a stereo audio connector with a microphone contact. When the headset is not connected, the internal pull-up resistors on L\_detect and GND\_detect pull those pins high. When the headset is connected to the switched audio jack, the headset ground and left audio channel trigger L\_detect and GND\_detect to logic low.

The NCS2300 can work with either the CTIA or OMTP standard. In order to support both standards simultaneously,

a cross point switch and additional circuitry is necessary to detect and swap the ground and microphone pins.

**MIC PIN BIASING**

The typical application schematic in Figure 1 shows the recommended 2.2 k $\Omega$  pull-up resistor to the MIC bias voltage. The MIC bias voltage can exceed VDD and can go as high as 3 V. While the headset is not detected, the internal NMOS transistor is enabled to mute the MIC signal. In the typical application scenario with a 2.2 k $\Omega$  pull-up to a 2.3 V MIC bias voltage, the MIC pin is pulled near 1 mV when the headset is not present. The internal NMOS transistor is optimized to sink up to 2 mA of current, allowing some flexibility in the selection of the pull-up resistor and MIC bias voltage.

# MECHANICAL CASE OUTLINE PACKAGE DIMENSIONS



UDFN6, 1.2x1.0, 0.4P  
CASE 517AA  
ISSUE D

DATE 03 SEP 2010

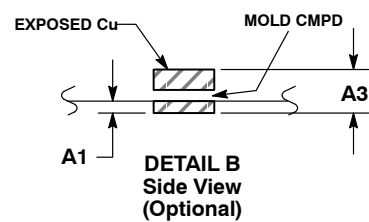
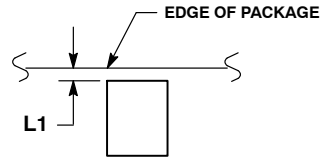
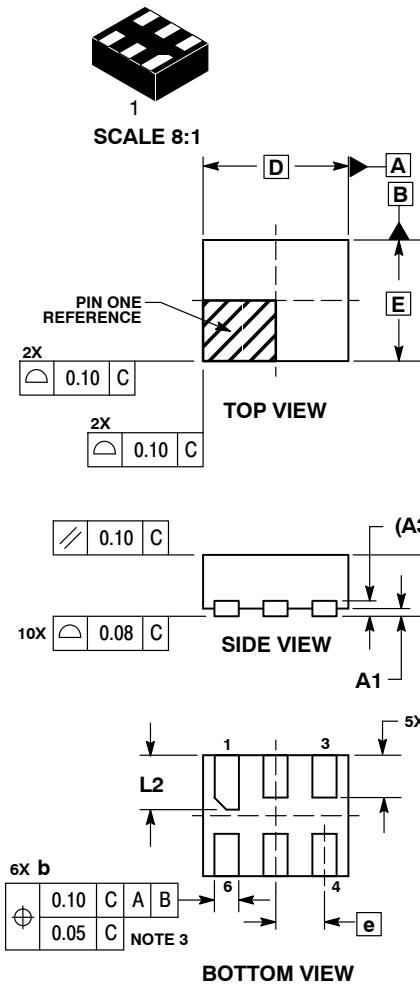

- NOTES:
1. DIMENSIONING AND TOLERANCING PER ASME Y14.5M, 1994.
  2. CONTROLLING DIMENSION: MILLIMETERS.
  3. DIMENSION b APPLIES TO PLATED TERMINAL AND IS MEASURED BETWEEN 0.25 AND 0.30 mm FROM TERMINAL.
  4. COPLANARITY APPLIES TO THE EXPOSED PAD AS WELL AS THE TERMINALS.

MILLIMETERS		
DIM	MIN	MAX
A	0.45	0.55
A1	0.00	0.05
A3	0.127	REF
b	0.15	0.25
D	1.20	BSC
E	1.00	BSC
e	0.40	BSC
L	0.30	0.40
L1	0.00	0.15
L2	0.40	0.50

### GENERIC MARKING DIAGRAM\*



X = Specific Device Code  
M = Date Code

\*This information is generic. Please refer to device data sheet for actual part marking. Pb-Free indicator, "G" or microdot "▪", may or may not be present.

### MOUNTING FOOTPRINT\*

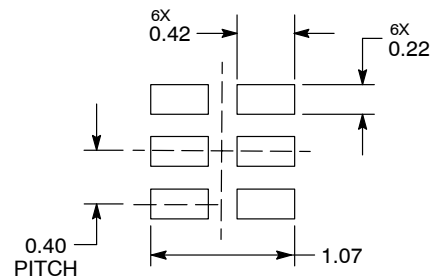

DIMENSIONS: MILLIMETERS

\*For additional information on our Pb-Free strategy and soldering details, please download the ON Semiconductor Soldering and Mounting Techniques Reference Manual, SOLDERRM/D.

<b>DOCUMENT NUMBER:</b>	<b>98AON22068D</b>	Electronic versions are uncontrolled except when accessed directly from the Document Repository. Printed versions are uncontrolled except when stamped "CONTROLLED COPY" in red.
<b>DESCRIPTION:</b>	<b>6 PIN UDFN, 1.2X1.0, 0.4P</b>	<b>PAGE 1 OF 1</b>

onsemi and onsemi are trademarks of Semiconductor Components Industries, LLC dba onsemi or its subsidiaries in the United States and/or other countries. onsemi reserves the right to make changes without further notice to any products herein. onsemi makes no warranty, representation or guarantee regarding the suitability of its products for any particular purpose, nor does onsemi assume any liability arising out of the application or use of any product or circuit, and specifically disclaims any and all liability, including without limitation special, consequential or incidental damages. onsemi does not convey any license under its patent rights nor the rights of others.

**onsemi**, **Onsemi**, and other names, marks, and brands are registered and/or common law trademarks of Semiconductor Components Industries, LLC dba "**onsemi**" or its affiliates and/or subsidiaries in the United States and/or other countries. **onsemi** owns the rights to a number of patents, trademarks, copyrights, trade secrets, and other intellectual property. A listing of **onsemi**'s product/patent coverage may be accessed at [www.onsemi.com/site/pdf/Patent-Marking.pdf](http://www.onsemi.com/site/pdf/Patent-Marking.pdf). **onsemi** reserves the right to make changes at any time to any products or information herein, without notice. The information herein is provided "as-is" and **onsemi** makes no warranty, representation or guarantee regarding the accuracy of the information, product features, availability, functionality, or suitability of its products for any particular purpose, nor does **onsemi** assume any liability arising out of the application or use of any product or circuit, and specifically disclaims any and all liability, including without limitation special, consequential or incidental damages. Buyer is responsible for its products and applications using **onsemi** products, including compliance with all laws, regulations and safety requirements or standards, regardless of any support or applications information provided by **onsemi**. "Typical" parameters which may be provided in **onsemi** data sheets and/or specifications can and do vary in different applications and actual performance may vary over time. All operating parameters, including "Typicals" must be validated for each customer application by customer's technical experts. **onsemi** does not convey any license under any of its intellectual property rights nor the rights of others. **onsemi** products are not designed, intended, or authorized for use as a critical component in life support systems or any FDA Class 3 medical devices or medical devices with a same or similar classification in a foreign jurisdiction or any devices intended for implantation in the human body. Should Buyer purchase or use **onsemi** products for any such unintended or unauthorized application, Buyer shall indemnify and hold **onsemi** and its officers, employees, subsidiaries, affiliates, and distributors harmless against all claims, costs, damages, and expenses, and reasonable attorney fees arising out of, directly or indirectly, any claim of personal injury or death associated with such unintended or unauthorized use, even if such claim alleges that **onsemi** was negligent regarding the design or manufacture of the part. **onsemi** is an Equal Opportunity/Affirmative Action Employer. This literature is subject to all applicable copyright laws and is not for resale in any manner.

## ADDITIONAL INFORMATION

### TECHNICAL PUBLICATIONS:

Technical Library: [www.onsemi.com/design/resources/technical-documentation](http://www.onsemi.com/design/resources/technical-documentation)  
onsemi Website: [www.onsemi.com](http://www.onsemi.com)

### ONLINE SUPPORT: [www.onsemi.com/support](http://www.onsemi.com/support)

For additional information, please contact your local Sales Representative at [www.onsemi.com/support/sales](http://www.onsemi.com/support/sales)