

Linear Regulator - Low Output Voltage, Ultra-Fast Low Dropout, Enable 1.0 A



ON Semiconductor®

www.onsemi.com

NCP5661, NCV5661

The NCP5661/NCV5661 is a high performance, low dropout linear regulator designed for high power applications that require up to 1.0 A current. It is offered in both fixed and adjustable output versions. With output voltages as low as 0.9 V and ultra-fast response times for load transients, the NCP5661/NCV5661 also provides additional features such as Enable and Error Flag (for the fixed output version), increasing the utility of these devices. A thermally robust, 5 pin DPAK or DFN 3x3.3 mm, combined with an architecture that offers low ground current (independent of load), provides for a superior high-current LDO solution.

Features

- Ultra-Fast Transient Response (Settling Time: 1–3 μ s)
- Low Noise Without Bypass Capacitor (26 μ V_{rms})
- Low Ground Current Independent of Load (3.0 mA Maximum)
- Fixed/Adjustable Output Voltage Versions
- Enable Function
- Error Flag (Fixed Output Version)
- Current Limit Protection
- Thermal Protection
- 0.9 V Reference Voltage for Ultra-Low Output Operation
- Power Supply Rejection Ratio > 65 dB
- NCV Prefix for Automotive and Other Applications Requiring Unique Site and Control Change Requirements; AEC-Q100 Qualified and PPAP Capable
- These are Pb-Free Devices

Applications

- Servers
- ASIC Power Supplies
- Post Regulation for Power Supplies
- Constant Current Source
- Networking Equipment
- Gaming and STB Modules

MARKING DIAGRAMS

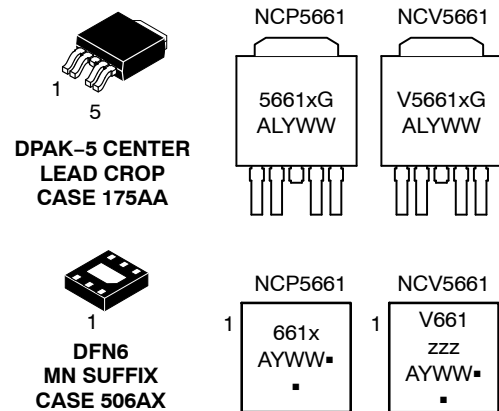

x = A for Adjustable Version
 B for Fixed 1.2 V
 C for Fixed 3.3 V
 D for Fixed 1.5 V
 E for Fixed 1.8 V
 F for Fixed 2.5 V
 G for Fixed 2.8 V
 H for Fixed 3.0 V

zzz = 12 for Fixed 1.2 V
 15 for Fixed 1.5 V
 18 for Fixed 1.8 V
 25 for Fixed 2.5 V
 28 for Fixed 2.8 V
 30 for Fixed 3.0 V
 33 for Fixed 3.3 V
 ADJ for Adjustable Version

A = Assembly Location
 L = Wafer Lot
 Y = Year
 WW = Work Week
 G = Pb-Free
 ▪ = Pb-Free Package

(Note: Microdot may be in either location)

ORDERING INFORMATION

See detailed ordering and shipping information in the package dimensions section on page 10 of this data sheet.

NCP5661, NCV5661

PIN FUNCTION DESCRIPTION

Pin Adj/Fixed DFN6	Pin Adj/Fixed DPAK-5	Pin Name	Description
1	1	Enable	This pin allows for on/off control of the regulator. To disable the device, connect to Ground. If this function is not in use, connect to V_{in} .
2,3	2	V_{in}	Positive Power Supply Input Voltage
4, EPAD	3, TAB	Ground	Power Supply Ground
5	4	V_{out}	Regulated Output Voltage
6	5	Adj (Adjustable Version)	This pin is connected to the resistor divider network and programs the output voltage.
6	5	Error Flag (Fixed Version)	An Error Flag is triggered when the output voltage is out of regulation excluding transient signals that may occur. Requires a pullup resistor $\approx 100\text{ k}\Omega$.

MAXIMUM RATINGS

Rating	Symbol	Value	Unit
Input Voltage	V_{in}	18	V
Output Pin Voltage	V_{out}	-0.3 to $V_{in} + 0.3$	V
Adjust Pin Voltage	V_{adj}	-0.3 to $V_{in} + 0.3$	V
Enable Pin Voltage	V_{en}	-0.3 to $V_{in} + 0.3$	V
Error Flag Voltage	V_{ef}	-0.3 to $V_{in} + 0.3$	V
Error Flag Current	I_{ef}	3.0	mA
Thermal Characteristics, DPAK-5 (Note 1) Thermal Resistance, Junction-to-Air Thermal Resistance, Junction-to-Case	$R_{\theta JA}$ $R_{\theta JC}$	100 8.0	$^{\circ}\text{C}/\text{W}$
Thermal Characteristics, DFN6 (Note 2) Thermal Resistance, Junction-to-Air Thermal Resistance, Junction-to-Lead (Note 3)	$R_{\theta JA}$ $R_{\theta JL}$	82 18	$^{\circ}\text{C}/\text{W}$
Operating Junction Temperature Range	T_J	-40 to +150	$^{\circ}\text{C}$
Storage Temperature Range	T_{stg}	-55 to +150	$^{\circ}\text{C}$

Stresses exceeding those listed in the Maximum Ratings table may damage the device. If any of these limits are exceeded, device functionality should not be assumed, damage may occur and reliability may be affected.

NOTE: This device series contains ESD protection and exceeds the following tests:

Human Body Model (HBM) JESD 22-A114-B

Machine Model (MM) JESD 22-A115-A.

The maximum package power dissipation is:

$$P_D = \frac{T_{J(\max)} - T_A}{R_{\theta JA}}$$

The bipolar process employed for this IC is fully characterized and rated for reliable 18 V $V_{CC\max}$ operation. To avoid damaging the part or degrading its reliability, power dissipation transients should be limited to under 20 W for DPAK.

For open-circuit to short-circuit transient,

$$P_{D\text{Transient}} = V_{CC\max} * I_{SC}$$

- 1 oz copper, 0.26 in² copper area (minimum pad)
- 1 oz copper, 1 in² copper area
- Lead 2

NCP5661, NCV5661

ELECTRICAL CHARACTERISTICS

($V_{in} - V_{out} = 1.5\text{ V}$, for typical values $T_J = 25^\circ\text{C}$, for min/max values $T_J = -40^\circ\text{C}$ to 125°C , $C_{in} = C_{out} = 150\ \mu\text{F}$ unless otherwise noted.)

Characteristic	Symbol	Min	Typ	Max	Unit
ADJUSTABLE OUTPUT VERSION					
Input Voltage	V_{in}	2.0	–	9.0	V
Output Noise Voltage (f = 10 Hz to 100 kHz)	V_n	–	26	–	μV_{rms}
Output Voltage Accuracy $T_J = 25^\circ\text{C}$ ($I_{out} = 10\text{ mA}$ to 1.0 A) $T_J = -20$ to $+125^\circ\text{C}$ ($I_{out} = 10\text{ mA}$ to 1.0 A) $T_J = -40$ to $+150^\circ\text{C}$ ($I_{out} = 10\text{ mA}$ to 1.0 A)	V_{out}	-1% -1.5% -2%	– 0.9 –	+1% +1.5% +2%	V
Adjustable Pin Input Current	I_{adj}	–	40	–	nA
Line Regulation ($I_{out} = 10\text{ mA}$, $V_{out} + 1.5\text{ V} < V_{in} < 7.0\text{ V}$)	REG_{line}	–	0.03	–	%
Load Regulation ($10\text{ mA} < I_{out} < 1.0\text{ A}$)	REG_{load}	–	0.03	–	%
Dropout Voltage ($I_{out} = 1.0\text{ A}$)	V_{DO}	–	1.0	1.3	V
Peak Output Current Limit	I_{out}	1.0	–	–	A
Internal Current Limitation	I_{lim}	–	1.5	–	A
Ripple Rejection (120 Hz)	RR	–	70	–	dB
Ripple Rejection (1.0 kHz)		–	65	–	
Thermal Shutdown (Guaranteed by Design)	T_{SHD}	–	160	–	$^\circ\text{C}$
Ground Current $I_{out} = 1.0\text{ A}$ Disabled State	I_q I_{qds}	– –	1.3 10	3.0 300	mA μA
Enable Input Threshold Voltage Voltage Increasing, On State, Logic High Voltage Decreasing, Off State, Logic Low	V_{en}	1.3 –	– –	– 0.3	V
Enable Input Current Enable Pin Voltage = $0.3 V_{max}$ Enable Pin Voltage = $1.3 V_{min}$	I_{en}	– –	0.5 0.5	– –	μA

Product parametric performance is indicated in the Electrical Characteristics for the listed test conditions, unless otherwise noted. Product performance may not be indicated by the Electrical Characteristics if operated under different conditions.

NCP5661, NCV5661

ELECTRICAL CHARACTERISTICS

($V_{in} - V_{out} = 1.5$ V, for typical values $T_J = 25^\circ\text{C}$, for min/max values $T_J = -40^\circ\text{C}$ to 125°C , $C_{in} = C_{out} = 150$ μF unless otherwise noted.)

Characteristic	Symbol	Min	Typ	Max	Unit
FIXED OUTPUT VOLTAGE					
Input Voltage	V_{in}	2.0	–	9.0	V
Output Noise Voltage ($V_{out} = 0.9$ V)	V_n	–	26	–	μV_{rms}
Output Voltage Accuracy $T_J = 25^\circ\text{C}$ ($I_{out} = 10$ mA to 1.0 A) $T_J = -20$ to $+125^\circ\text{C}$ ($I_{out} = 10$ mA to 1.0 A) $T_J = -40$ to $+150^\circ\text{C}$ ($I_{out} = 10$ mA to 1.0 A)	V_{out}	-1% -1.5% -2%	– V_{out} –	+1% +1.5% +2%	V
Line Regulation ($I_{out} = 10$ mA, $V_{out} + 1.5$ V < V_{in} < 7.0 V)	REG_{line}	–	0.03	–	%
Load Regulation (10 mA < I_{out} < 1.0 A)	REG_{load}	–	0.2	–	%
Dropout Voltage ($I_{out} = 1.0$ A)	V_{DO}	–	1.0	1.3	V
Peak Output Current Limit	I_{out}	1.0	–	–	A
Internal Current Limitation	I_{lim}	–	1.5	–	A
Ripple Rejection (120 Hz)	RR	–	70	–	dB
Ripple Rejection (1.0 kHz)		–	65	–	
Thermal Shutdown (Guaranteed by Design)	T_{SHD}	–	160	–	$^\circ\text{C}$
Ground Current $I_{out} = 1.0$ A Disabled State	I_q I_{qds}	– –	1.3 30	3.0 300	mA μA
Enable Input Threshold Voltage Voltage Increasing, On State, Logic High Voltage Decreasing, Off State, Logic Low	V_{en}	1.3 –	– –	– 0.3	V
Enable Input Current Enable Pin Voltage = $0.3 V_{\text{max}}$ Enable Pin Voltage = $1.3 V_{\text{min}}$	I_{en}	– –	0.5 0.5	– –	μA
Error Flag (Fixed Output) 1.2 V Output 1.5 V Output 1.8 V Output 2.5 V Output 2.8 V Output 3.0 V Output 3.3 V Output	V_{efft}	88 88 88 88 88 88 90	92 92 92 92 92 92 94	97 97 97 97 97 97 97	% of V_{out}
Error Flag Output Low Voltage Saturation ($I_{ef} = 1.0$ mA)	V_{efdo}	–	200	–	mV
Error Flag Leakage	I_{efleak}	–	1.0	–	μA
Error Flag Blanking Time (Note 4)	T_{ef}	–	50	–	μs

Product parametric performance is indicated in the Electrical Characteristics for the listed test conditions, unless otherwise noted. Product performance may not be indicated by the Electrical Characteristics if operated under different conditions.

4. Error Flag Blanking Time

NCP5661, NCV5661

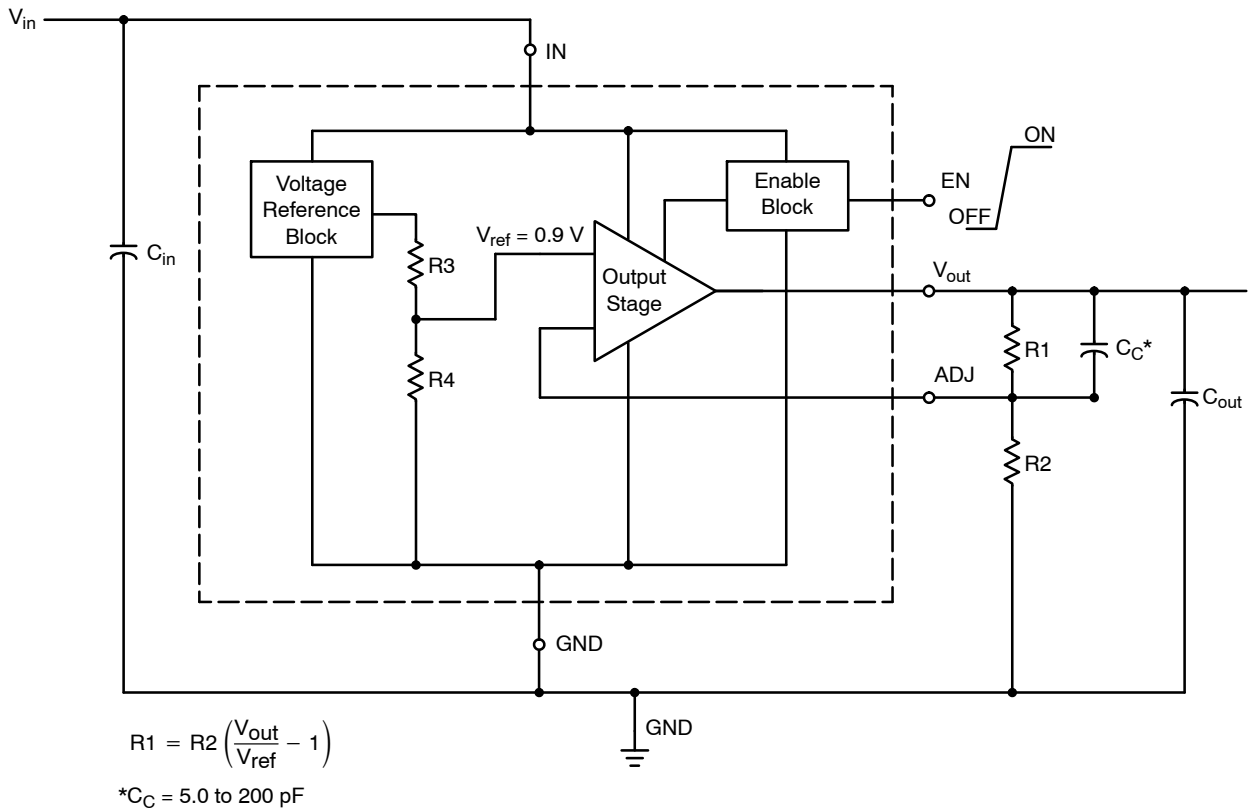

Figure 1. Typical Schematic, Adjustable Output Version

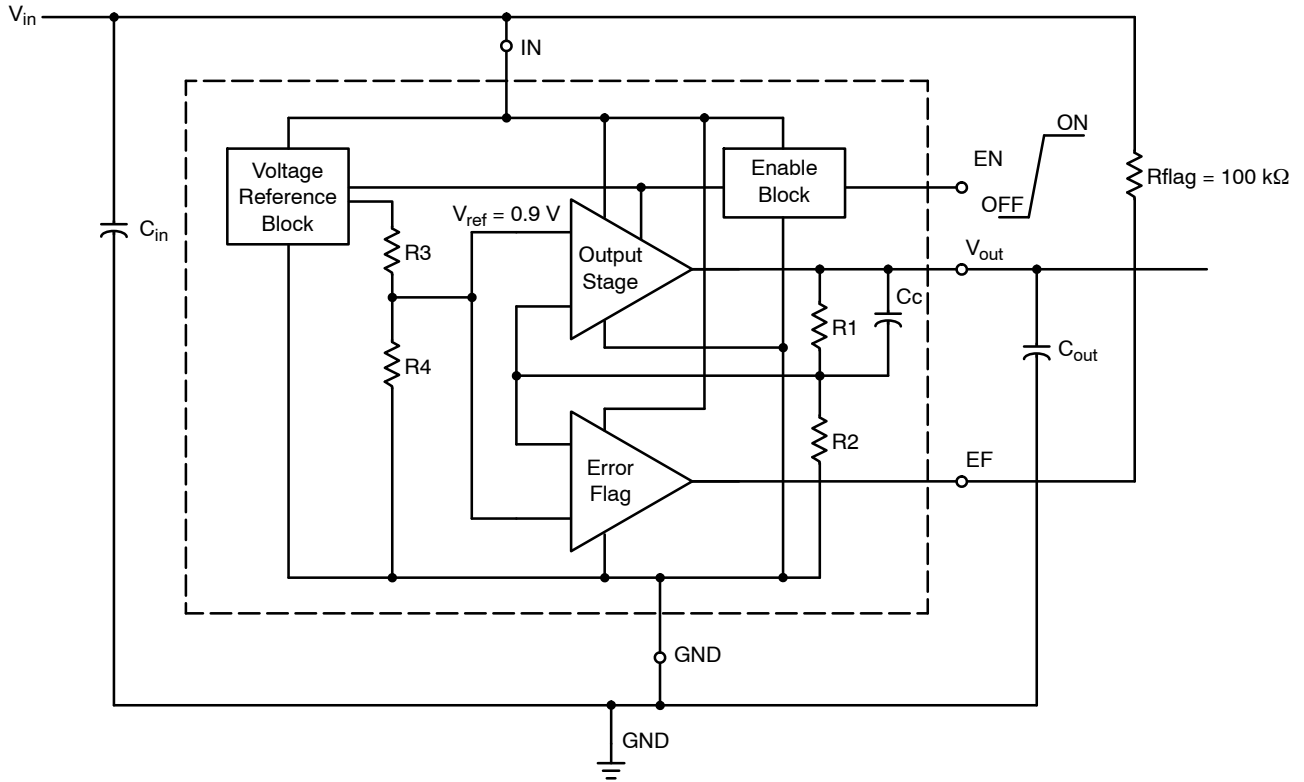

Figure 2. Typical Schematic, Fixed Output Version

NCP5661, NCV5661

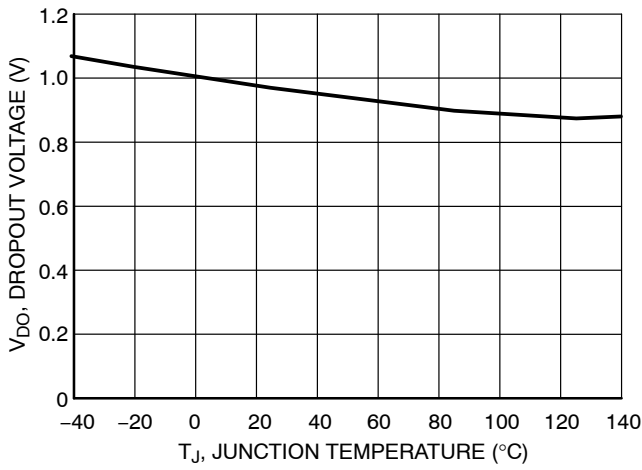

Figure 3. Dropout Voltage vs. Temperature

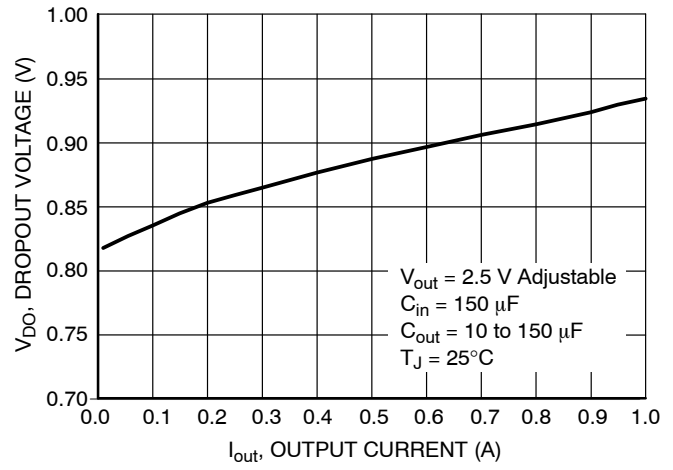

Figure 4. Dropout Voltage vs. Output Current

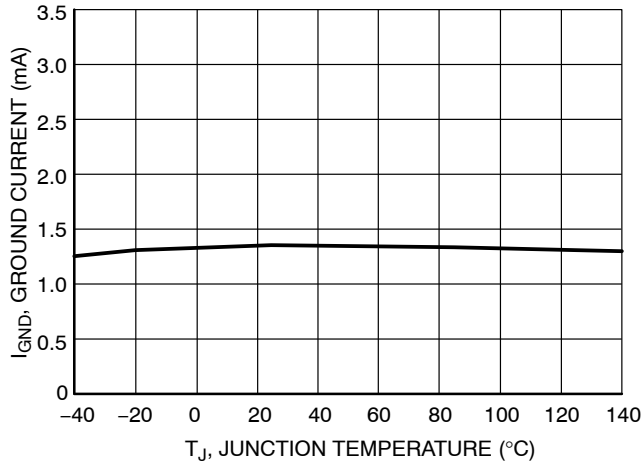

Figure 5. Ground Current vs. Temperature

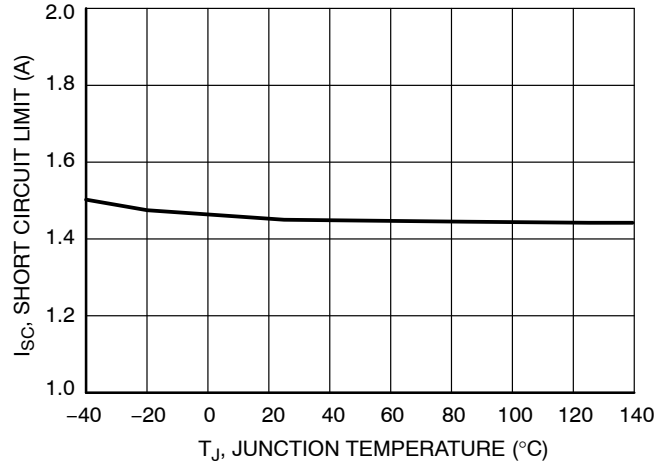

Figure 6. Short Circuit Current Limit vs. Temperature

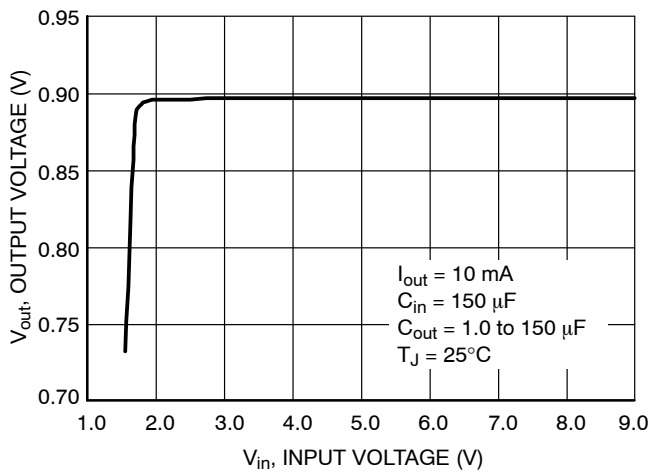

Figure 7. Output Voltage vs. Input Voltage

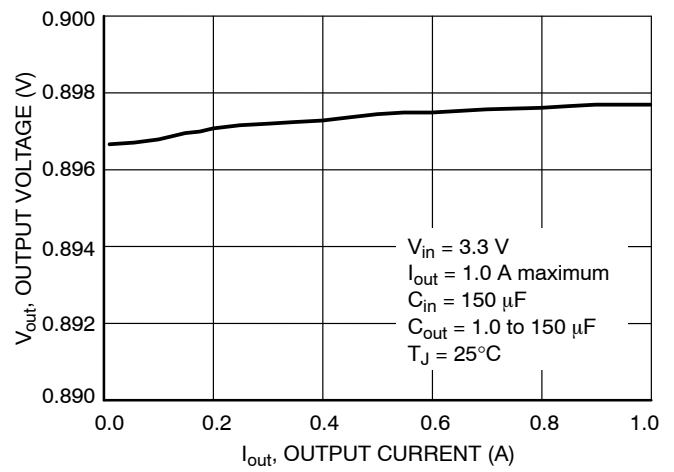

Figure 8. Output Voltage vs. Output Load Current

NCP5661, NCV5661

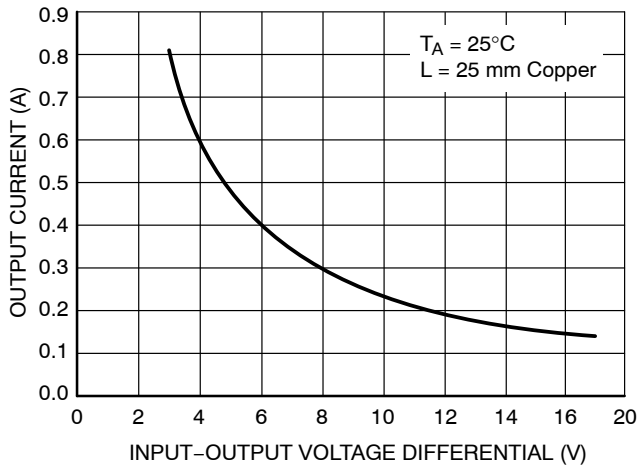

Figure 9. Output Current vs. Input-Output Voltage Differential

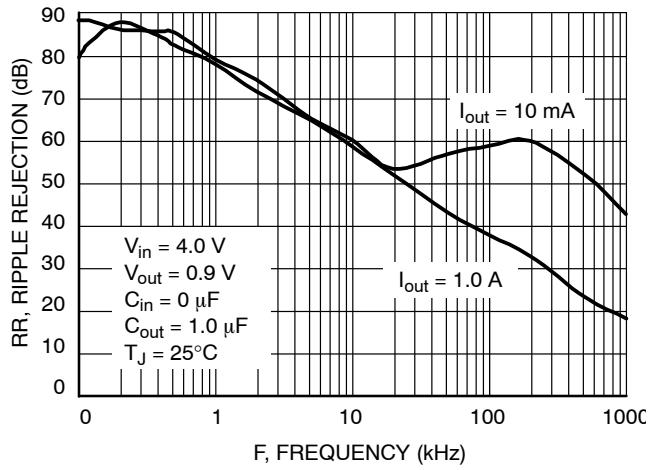

Figure 10. Ripple Rejection vs. Frequency

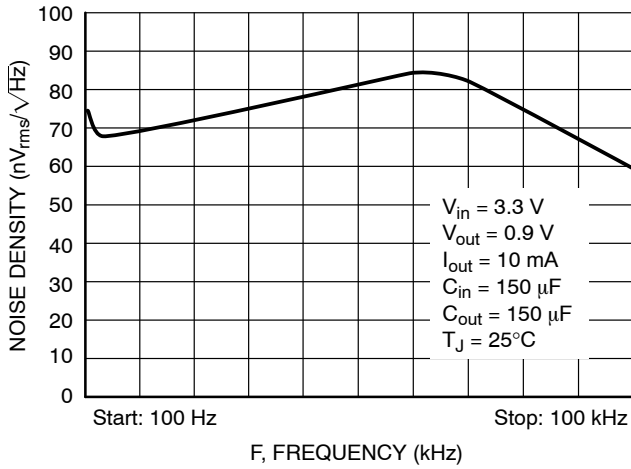

Figure 11. Noise Density vs. Frequency

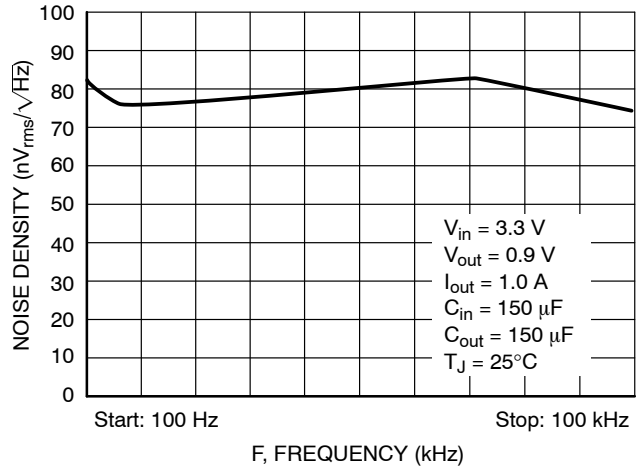

Figure 12. Noise Density vs. Frequency

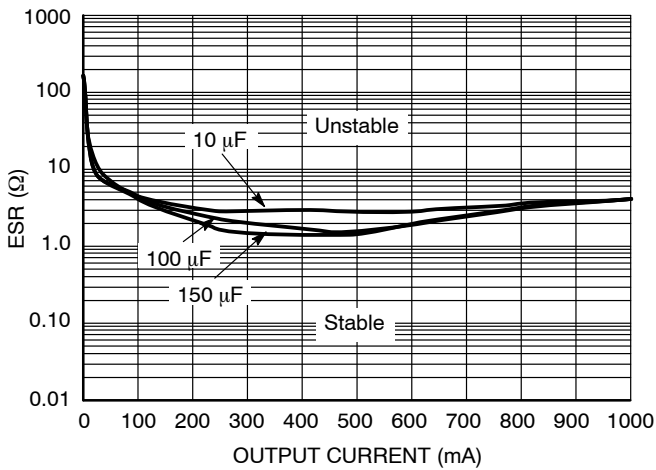

Figure 13. 1.2 Volt Output Stability with Output Capacitor ESR

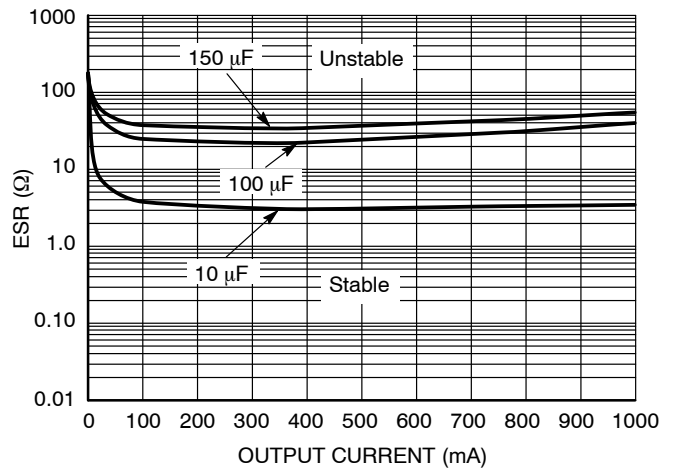

Figure 14. 3.3 Volt Output Stability with Output Capacitor ESR

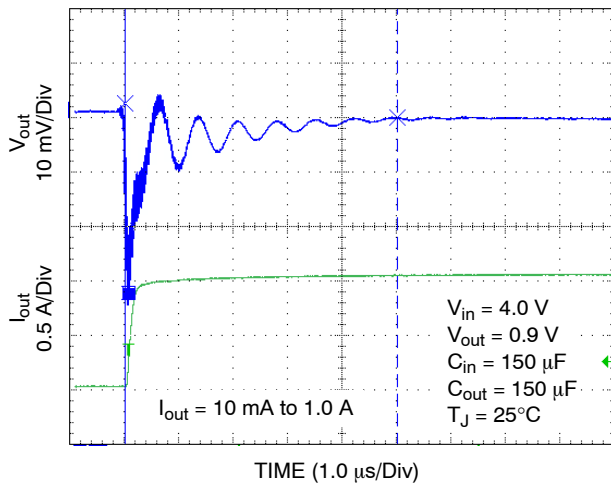

Figure 15. Load Transient Response

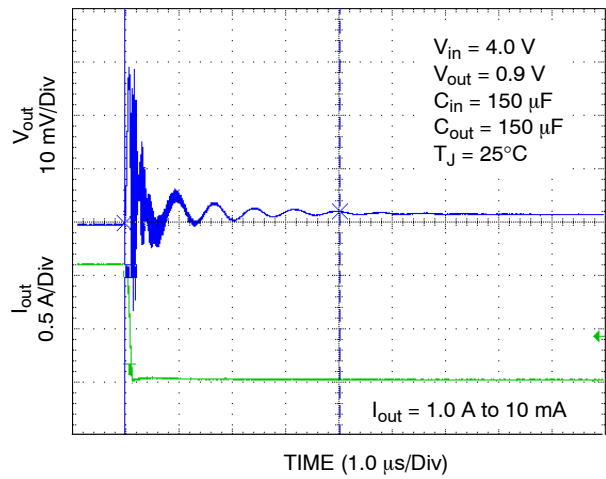

Figure 16. Load Transient Response

APPLICATION INFORMATION

The NCP5661 is a high performance low dropout 1.0 A linear regulator suitable for high power applications, featuring an ultra-fast response time and low noise without a bypass capacitor. It is offered in both fixed and adjustable output versions with voltages as low as 0.9 V. Additional features, such as Enable and Error Flag (fixed output version) increase the utility of the NCP5661. It is thermally robust and includes the safety features necessary during a fault condition, which provide for an attractive high current LDO solution for server, ASIC power supplies, networking equipment applications, and many others.

Input Capacitor

The recommended input capacitor value is a 150 μF OSCON with an Equivalent Series Resistance (ESR) of 50 mΩ. It is especially required if the power source is located more than a few inches from the NCP5661. This capacitor will reduce device sensitivity and enhance the output transient response time. The PCB layout is very important and in order to obtain the optimal solution, the Vin and GND traces should be sufficiently wide to minimize noise and unstable operation.

Output Capacitor

Proper output capacitor selection is required to maintain stability. The NCP5661 is guaranteed to be stable at an output capacitance of Cout > 10 μF. In the case of using electrolytic capacitors, low ESR type (ESR < 300 mΩ) should be used to maintain device stability. Multilayer ceramic capacitors can also be used with this device. For PCB layout considerations, place the recommended ceramic capacitor close to the output pin and keep the leads short. This should help ensure ultra-fast transient response times.

Adjustable Output Operation

The application circuit for the adjustable output version is shown in Figure 1. The reference voltage is 0.9 V and the

adjustable pin current is typically 40 nA. A resistor divider network, R1 and R2, is calculated using the following formula:

$$R1 = R2 \left(\frac{V_{out}}{V_{ref}} - 1 \right)$$

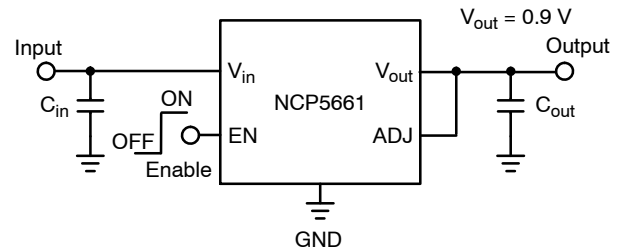

Figure 17. To achieve the minimum output voltage, ADJ to Vout has to be connected together

Current Limit Operation

As the peak output current increases beyond its limitation, the device is internally clamped to 1.5 A, thus causing the output voltage to decrease and go out of regulation. This allows the device never to exceed the maximum power dissipation.

Error Flag Operation

The Error Flag pin on the NCP5661 will produce a logic Low when it drops below the nominal output voltage. Refer to the electrical characteristics for the threshold values at which point the Error Flag goes Low. When the NCP5661 is above the nominal output voltage, the Error Flag will remain at logic High.

The external pullup resistor needs to be connected between Vin (Pin 1) and the Error Flag pin (Pin 5). A resistor of approximately 100 kΩ is recommended to minimize the current consumption. No pullup resistor is required if the Error Flag output is not being used.

NCP5661, NCV5661

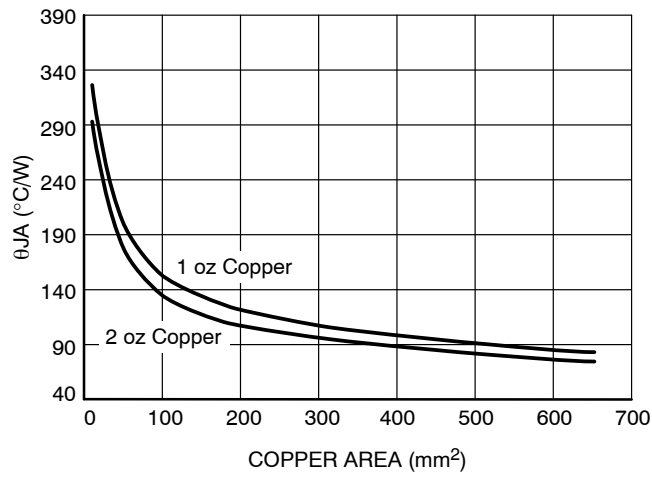

Figure 18. DFN6 Thermal Resistance vs. Copper Area

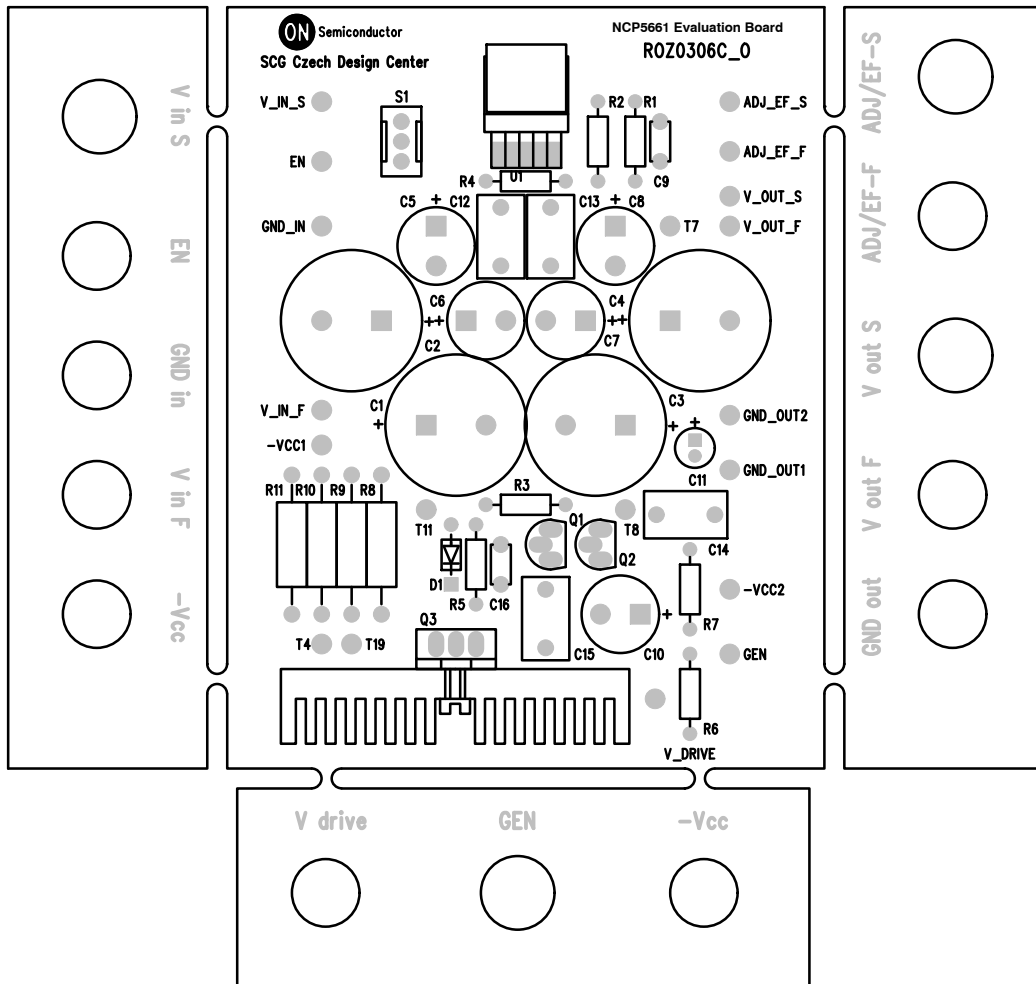

Figure 19. Test Board used for Evaluation

NCP5661, NCV5661

ORDERING INFORMATION

Device	Nominal Output Voltage	Package	Shipping†
NCP5661DTADJRKG	Adj (Pb-Free)	DPAK	2500/Tape & Reel
NCP5661DT12RKG	Fixed, 1.2 V (Pb-Free)		
NCP5661DT18RKG	Fixed, 1.8 V (Pb-Free)		
NCP5661DT25RKG	Fixed, 2.5 V (Pb-Free)		
NCP5661DT33RKG	Fixed, 3.3 V (Pb-Free)		
NCV5661DTADJRKG*	Adj (Pb-Free)		
NCV5661DT12RKG*	Fixed, 1.2 V (Pb-Free)		
NCV5661DT18RKG*	Fixed, 1.8 V (Pb-Free)		
NCV5661DT33RKG*	Fixed, 3.3 V (Pb-Free)		
NCP5661MNADJT2G	Adj (Pb-Free)	DFN6 3x3.3 mm	3000/Tape & Reel
NCP5661MN12T2G	Fixed, 1.2 V (Pb-Free)		
NCP5661MN15T2G	Fixed, 1.5 V (Pb-Free)		
NCP5661MN18T2G	Fixed, 1.8 V (Pb-Free)		
NCP5661MN25T2G	Fixed, 2.5 V (Pb-Free)		
NCP5661MN28T2G	Fixed, 2.8 V (Pb-Free)		
NCP5661MN30T2G	Fixed, 3.0 V (Pb-Free)		
NCP5661MN33T2G	Fixed, 3.3 V (Pb-Free)		
NCV5661MNADJT2G*	Adj (Pb-Free)		
NCV5661MN12T2G*	Fixed, 1.2 V (Pb-Free)		
NCV5661MN15T2G*	Fixed, 1.5 V (Pb-Free)		
NCV5661MN18T2G*	Fixed, 1.8 V (Pb-Free)		
NCV5661MN25T2G*	Fixed, 2.5 V (Pb-Free)		
NCV5661MN28T2G*	Fixed, 2.8 V (Pb-Free)		
NCV5661MN30T2G*	Fixed, 3.0 V (Pb-Free)		
NCV5661MN33T2G*	Fixed, 3.3 V (Pb-Free)		

NOTE: Additional Fix output voltages are available upon request.

†For information on tape and reel specifications, including part orientation and tape sizes, please refer to our Tape and Reel Packaging Specifications Brochure, BRD8011/D.

*NCV Prefix for Automotive and Other Applications Requiring Unique Site and Control Change Requirements; AEC-Q100 Qualified and PPAP Capable

MECHANICAL CASE OUTLINE

PACKAGE DIMENSIONS

ON Semiconductor®

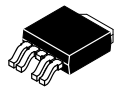

DPAK-5, CENTER LEAD CROP

CASE 175AA

ISSUE B

DATE 15 MAY 2014

SCALE 1:1

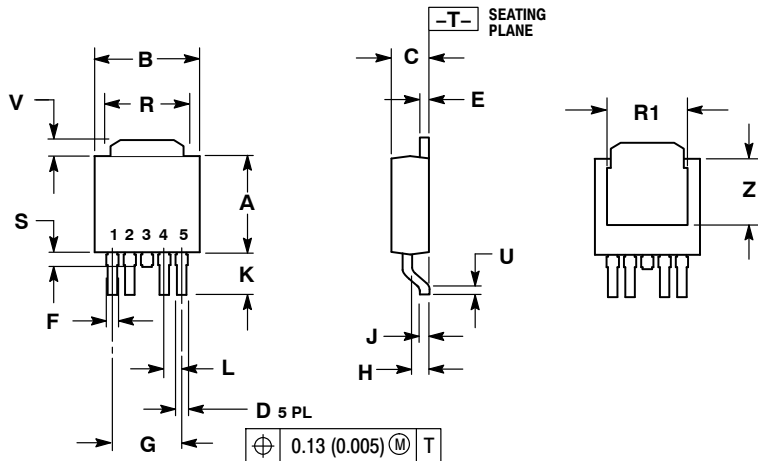

- NOTES:
1. DIMENSIONING AND TOLERANCING PER ANSI Y14.5M, 1982.
 2. CONTROLLING DIMENSION: INCH.

DIM	INCHES		MILLIMETERS	
	MIN	MAX	MIN	MAX
A	0.235	0.245	5.97	6.22
B	0.250	0.265	6.35	6.73
C	0.086	0.094	2.19	2.38
D	0.020	0.028	0.51	0.71
E	0.018	0.023	0.46	0.58
F	0.024	0.032	0.61	0.81
G	0.180 BSC		4.56 BSC	
H	0.034	0.040	0.87	1.01
J	0.018	0.023	0.46	0.58
K	0.102	0.114	2.60	2.89
L	0.045 BSC		1.14 BSC	
R	0.170	0.190	4.32	4.83
R1	0.185	0.210	4.70	5.33
S	0.025	0.040	0.63	1.01
U	0.020	---	0.51	---
V	0.035	0.050	0.89	1.27
Z	0.155	0.170	3.93	4.32

RECOMMENDED SOLDERING FOOTPRINT*

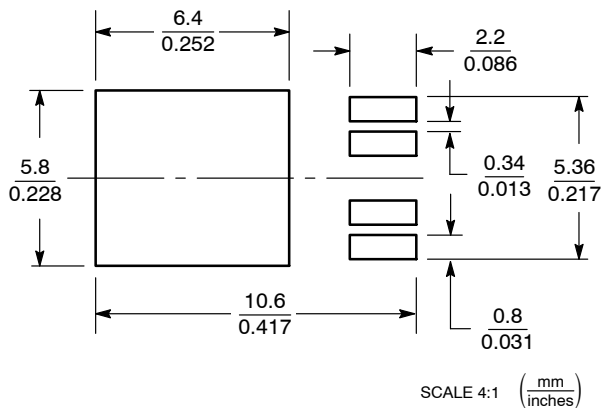

*For additional information on our Pb-Free strategy and soldering details, please download the ON Semiconductor Soldering and Mounting Techniques Reference Manual, SOLDERRM/D.

GENERIC MARKING DIAGRAMS*

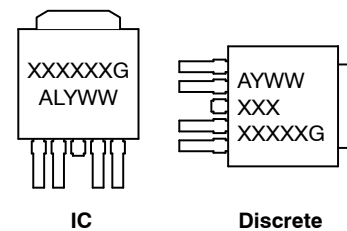

- XXXXXX = Device Code
- A = Assembly Location
- L = Wafer Lot
- Y = Year
- WW = Work Week
- G = Pb-Free Package

*This information is generic. Please refer to device data sheet for actual part marking. Pb-Free indicator, "G" or microdot "▪", may or may not be present.

DOCUMENT NUMBER:	98AON12855D	Electronic versions are uncontrolled except when accessed directly from the Document Repository. Printed versions are uncontrolled except when stamped "CONTROLLED COPY" in red.
DESCRIPTION:	DPAK-5 CENTER LEAD CROP	PAGE 1 OF 1

ON Semiconductor and are trademarks of Semiconductor Components Industries, LLC dba ON Semiconductor or its subsidiaries in the United States and/or other countries. ON Semiconductor reserves the right to make changes without further notice to any products herein. ON Semiconductor makes no warranty, representation or guarantee regarding the suitability of its products for any particular purpose, nor does ON Semiconductor assume any liability arising out of the application or use of any product or circuit, and specifically disclaims any and all liability, including without limitation special, consequential or incidental damages. ON Semiconductor does not convey any license under its patent rights nor the rights of others.

MECHANICAL CASE OUTLINE

PACKAGE DIMENSIONS

ON Semiconductor®

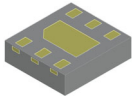

DFN6 3.0x3.3, 0.95P

CASE 506AX

ISSUE A

DATE 22 SEP 2020

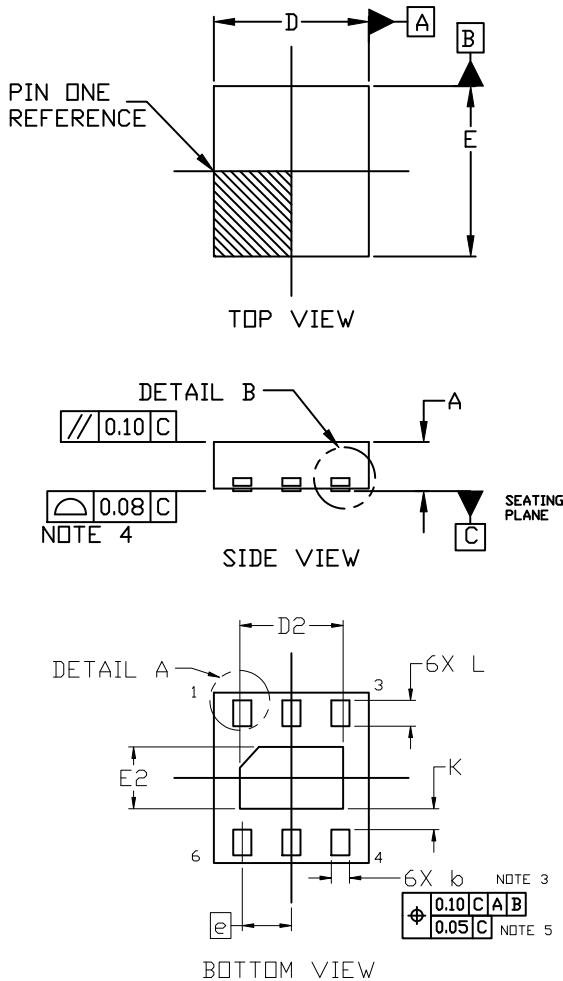

- NOTES:
1. DIMENSIONING AND TOLERANCING PER ASME Y14.5M, 2009.
 2. CONTROLLING DIMENSION: MILLIMETERS
 3. DIMENSION *b* APPLIES TO PLATED TERMINALS AND IS MEASURED BETWEEN 0.15 AND 0.30MM FROM THE TERMINAL TIP.
 4. COPLANARITY APPLIES TO THE EXPOSED PAD AS WELL AS THE TERMINALS.
 5. POSITIONAL TOLERANCE APPLIES TO THE EXPOSED PAD AS WELL AS THE TERMINALS.

DIM	MILLIMETERS		
	MIN.	NOM.	MAX.
A	0.80	0.90	1.00
A1	0.00	---	0.05
b	0.30	0.35	0.40
D	2.90	3.00	3.10
D2	1.90	2.00	2.10
E	3.20	3.30	3.40
E2	1.10	1.20	1.30
e	0.95 BSC		
K	0.40 REF		
L	0.40	0.50	0.60
L1	0.00	---	0.15

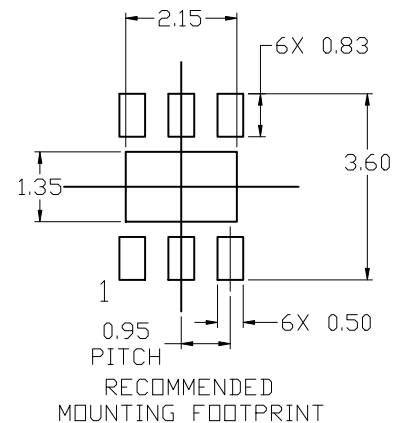

GENERIC MARKING DIAGRAM*

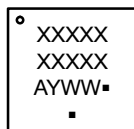

- XXXX = Specific Device Code
- A = Assembly Location
- Y = Year
- WW = Work Week
- = Pb-Free Package

(Note: Microdot may be in either location)

* For additional information on our Pb-Free strategy and soldering details, please download the ON Semiconductor Soldering and Mounting Techniques Reference Manual, SOLDERM/D.

*This information is generic. Please refer to device data sheet for actual part marking. Pb-Free indicator, "G" or microdot "▪", may or may not be present. Some products may not follow the Generic Marking.

DOCUMENT NUMBER:	98AON21930D	Electronic versions are uncontrolled except when accessed directly from the Document Repository. Printed versions are uncontrolled except when stamped "CONTROLLED COPY" in red.
DESCRIPTION:	DFN6 3.0X3.3, 0.95P	PAGE 1 OF 1

ON Semiconductor and ON are trademarks of Semiconductor Components Industries, LLC dba ON Semiconductor or its subsidiaries in the United States and/or other countries. ON Semiconductor reserves the right to make changes without further notice to any products herein. ON Semiconductor makes no warranty, representation or guarantee regarding the suitability of its products for any particular purpose, nor does ON Semiconductor assume any liability arising out of the application or use of any product or circuit, and specifically disclaims any and all liability, including without limitation special, consequential or incidental damages. ON Semiconductor does not convey any license under its patent rights nor the rights of others.

onsemi, **Onsemi**, and other names, marks, and brands are registered and/or common law trademarks of Semiconductor Components Industries, LLC dba "**onsemi**" or its affiliates and/or subsidiaries in the United States and/or other countries. **onsemi** owns the rights to a number of patents, trademarks, copyrights, trade secrets, and other intellectual property. A listing of **onsemi**'s product/patent coverage may be accessed at www.onsemi.com/site/pdf/Patent-Marking.pdf. **onsemi** reserves the right to make changes at any time to any products or information herein, without notice. The information herein is provided "as-is" and **onsemi** makes no warranty, representation or guarantee regarding the accuracy of the information, product features, availability, functionality, or suitability of its products for any particular purpose, nor does **onsemi** assume any liability arising out of the application or use of any product or circuit, and specifically disclaims any and all liability, including without limitation special, consequential or incidental damages. Buyer is responsible for its products and applications using **onsemi** products, including compliance with all laws, regulations and safety requirements or standards, regardless of any support or applications information provided by **onsemi**. "Typical" parameters which may be provided in **onsemi** data sheets and/or specifications can and do vary in different applications and actual performance may vary over time. All operating parameters, including "Typicals" must be validated for each customer application by customer's technical experts. **onsemi** does not convey any license under any of its intellectual property rights nor the rights of others. **onsemi** products are not designed, intended, or authorized for use as a critical component in life support systems or any FDA Class 3 medical devices or medical devices with a same or similar classification in a foreign jurisdiction or any devices intended for implantation in the human body. Should Buyer purchase or use **onsemi** products for any such unintended or unauthorized application, Buyer shall indemnify and hold **onsemi** and its officers, employees, subsidiaries, affiliates, and distributors harmless against all claims, costs, damages, and expenses, and reasonable attorney fees arising out of, directly or indirectly, any claim of personal injury or death associated with such unintended or unauthorized use, even if such claim alleges that **onsemi** was negligent regarding the design or manufacture of the part. **onsemi** is an Equal Opportunity/Affirmative Action Employer. This literature is subject to all applicable copyright laws and is not for resale in any manner.

ADDITIONAL INFORMATION

TECHNICAL PUBLICATIONS:

Technical Library: www.onsemi.com/design/resources/technical-documentation
onsemi Website: www.onsemi.com

ONLINE SUPPORT: www.onsemi.com/support

For additional information, please contact your local Sales Representative at www.onsemi.com/support/sales