

# NCP5220

## 3-in-1 PWM Dual Buck and Linear Power Controller

The NCP5220 3-in-1 PWM a Dual Buck and Linear Power Controller, is a complete power solution for MCH and DDR memory. This IC combines the efficiency of PWM controllers for the VDDQ supply and the MCH core supply voltage with the simplicity of linear regulator for the VTT termination voltage.

This IC contains two synchronous PWM buck controller for driving four external N-Ch FETs to form the DDR memory supply voltage (VDDQ) and the MCH regulator. The DDR memory termination regulator (VTT) is designed to track at the half of reference voltage with sourcing and sinking current.

Protective features include, soft-start circuitry, undervoltage monitoring of 5VDUAL, BOOT voltage and thermal shutdown. The device is housed in a thermal enhanced space-saving DFN-20 package.

### Features

- Pb-Free Package is Available\*
- Incorporates Synchronous PWM Buck Controllers for VDDQ and VMCH
- Integrated Power FETs with VTT Regulator Source/Sink up to 2.0 A
- All External Power MOSFETs are N-Channel
- Adjustable VDDQ and VMCH by External Dividers
- VTT Tracks at Half the Reference Voltage
- Fixed Switching Frequency of 250 kHz for VDDQ and VMCH
- Doubled Switching Frequency of 500 kHz for VDDQ Controller in Standby Mode to Optimize Inductor Current Ripple and Efficiency
- Soft-Start Protection for All Controllers
- Undervoltage Monitor of Supply Voltages
- Overcurrent Protections for DDQ and VTT Regulators
- Fully Complies with ACPI Power Sequencing Specifications
- Short Circuit Protection Prevents Damage to Power Supply Due to Reverse DIMM Insertion
- Thermal Shutdown
- 5x6 DFN-20 Package

### Typical Applications

- DDR I and DDR II Memory and MCH Power Supply



ON Semiconductor®

<http://onsemi.com>

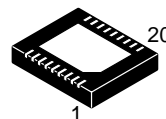

DFN-20  
MN SUFFIX  
CASE 505AB

### MARKING DIAGRAM

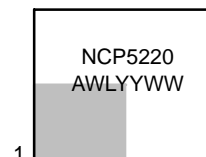

NCP5220 = Specific Device Code

A = Assembly Location

WL = Wafer Lot

YY = Year

WW = Work Week

### PIN CONNECTIONS

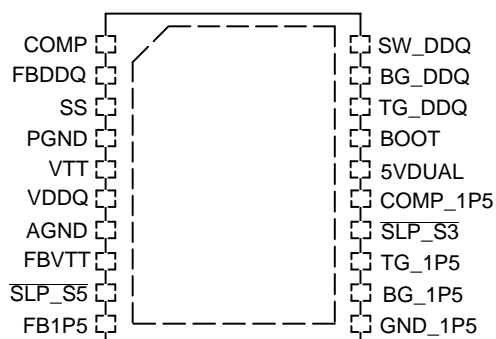

NOTE: Pin 21 is the thermal pad on the bottom of the device.

### ORDERING INFORMATION

Device	Package	Shipping†
NCP5220MNR2	DFN-20	2500 Tape & Reel
NCP5220MNR2G	DFN-20 (Pb-Free)	2500 Tape & Reel

†For information on tape and reel specifications, including part orientation and tape sizes, please refer to our Tape and Reel Packaging Specification Brochure, BRD8011/D.

\*For additional information on our Pb-Free strategy and soldering details, please download the ON Semiconductor Soldering and Mounting Techniques Reference Manual, SOLDERRM/D.

# NCP5220

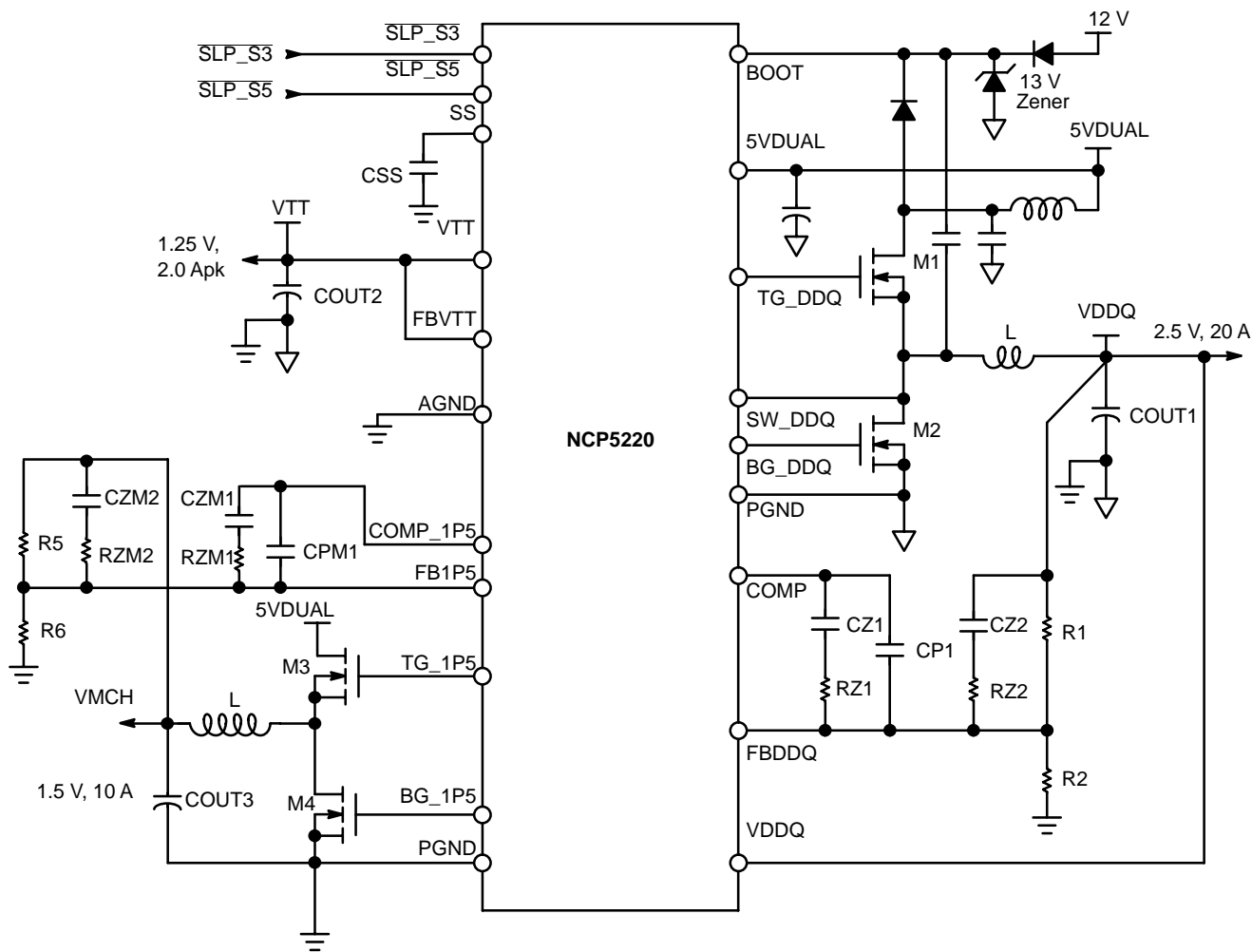

Figure 1. Application Diagram

# NCP5220

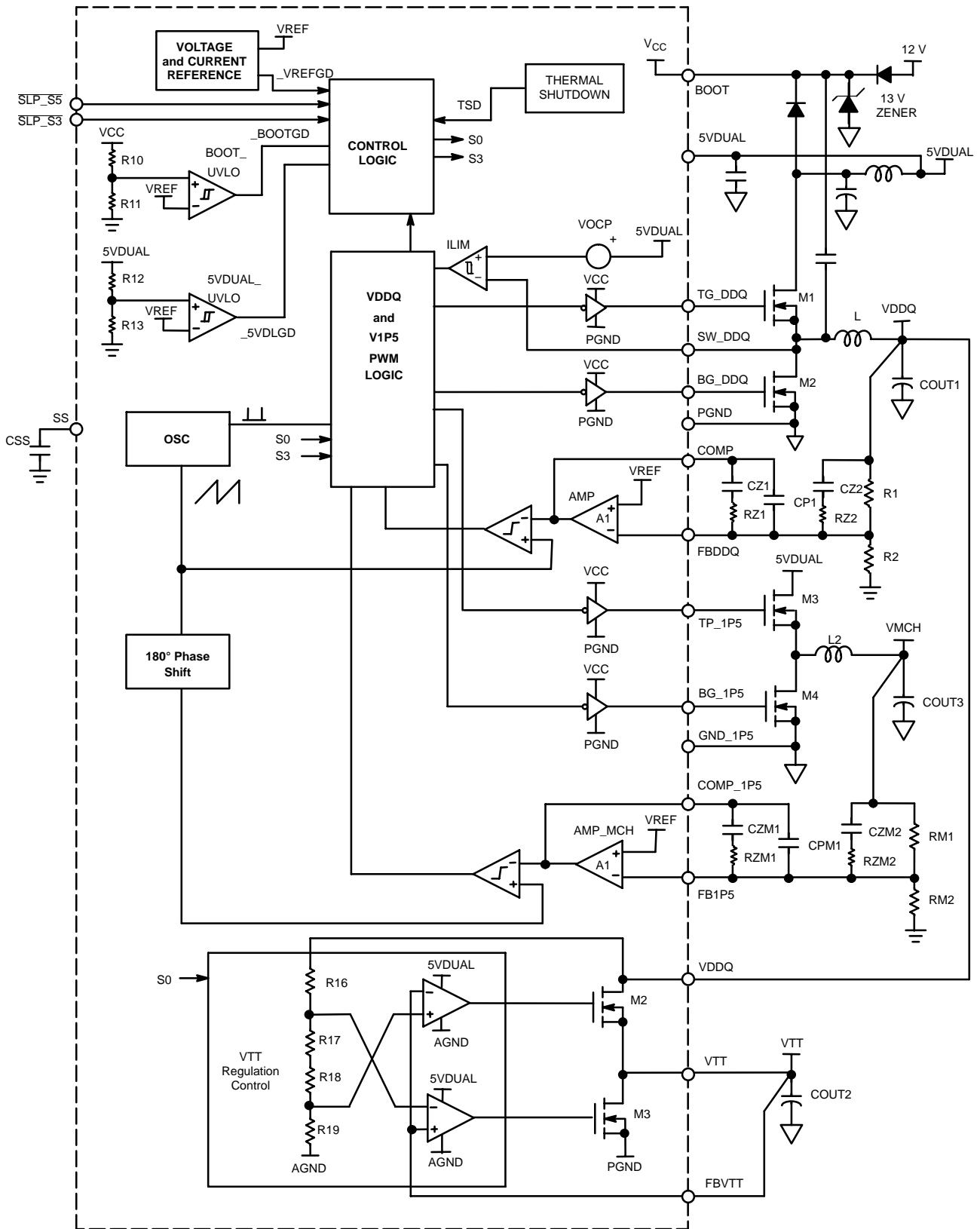

Figure 2. Internal Block Diagram

# NCP5220

## PIN DESCRIPTION

Pin	Symbol	Description
1	COMP	VDDQ error amplifier compensation node.
2	FBDDQ	DDQ regulator feedback pin.
3	SS	Soft-start pin of DDQ and MCH.
4	PGND	Power ground.
5	VTT	VTT regulator output.
6	VDDQ	Power input for VTT linear regulator.
7	AGND	Analog ground connection and remote ground sense.
8	FBVTT	VTT regulator pin for closed loop regulation.
9	SLP_S5	Active LOW control signal to activate S5 Power OFF State.
10	FB1P5	V1P5 switching regulator feedback pin.
11	GND_1P5	Power ground for V1P5 regulator.
12	BG_1P5	Gate driver output for V1P5 regulator low side N-Channel Power FET.
13	TG_1P5	Gate driver output for V1P5 regulator high side N-Channel Power FET.
14	SLP_S3	Active LOW control signal to activate S3 sleep state.
15	COMP_1P5	V1P5 error amplifier compensation node.
16	5VDUAL	5.0 V dual supply input, which is monitored by undervoltage lock out circuitry.
17	BOOT	Gate driver input supply, which is monitored by undervoltage lock out circuitry, and a boost capacitor connection between SWDDQ and this pin.
18	TG_DDQ	Gate driver output for DDQ regulator high side N-Channel Power FET.
19	BG_DDQ	Gate driver output for DDQ regulator low side N-Channel Power FET.
20	SW_DDQ	DDQ regulator switch node and current limit sense input.
21	TH_PAD	Copper pad on bottom of IC used for heatsinking. This pin should be connected to the ground plane under the IC.

## MAXIMUM RATINGS

Rating	Symbol	Value	Unit
Power Supply Voltage (Pin 16) to AGND (Pin 7)	5VDUAL	-0.3, 6.0	V
BOOT (Pin 17) to AGND (Pin 7)	BOOT	-0.3, 14	V
Gate Drive (Pins 12, 13, 18, 19) to AGND (Pin 7)	V <sub>g</sub>	-0.3 DC, -4.0 for < 100 ns; 14	V
Input / Output Pins to AGND (Pin 7) Pins 1-3, 5, 6, 8-10, 14-15, 20	V <sub>IO</sub>	-0.3, 6.0	V
PGND (Pin 4), GND_1P5 (Pin 11) to AGND (Pin 7)	V <sub>GND</sub>	-0.3, 0.3	V
Thermal Characteristics DFN-20 Plastic Package Thermal Resistance Junction-to-Air	R <sub>θJA</sub>	35	°C/W
Operating Junction Temperature Range	T <sub>J</sub>	0 to +150	°C
Operating Ambient Temperature Range	T <sub>A</sub>	0 to +70	°C
Storage Temperature Range	T <sub>stg</sub>	-55 to +150	°C
Moisture Sensitivity Level	MSL	2.0	

Maximum ratings are those values beyond which device damage can occur. Maximum ratings applied to the device are individual stress limit values (not normal operating conditions) and are not valid simultaneously. If these limits are exceeded, device functional operation is not implied, damage may occur and reliability may be affected.

1. This device series contains ESD protection and exceeds the following tests: Human Body Model (HBM) ± 2.0 kV per JEDEC standard: JESD22-A114. Machine Model (MM) ± 200 V per JEDEC standard: JESD22-A115.
2. Latchup Current Maximum Rating: ± 150 mA per JEDEC standard: JESD78.

# NCP5220

**ELECTRICAL CHARACTERISTICS** (5VDUAL = 5.0 V, BOOT = 12 V,  $T_A = 0^\circ\text{C}$  to  $70^\circ\text{C}$ , L = 1.7  $\mu\text{H}$ , COUT1 = 3770  $\mu\text{F}$ , COUT2 = 470  $\mu\text{F}$ , COUT3 = NA, CSS = 33 nF, R1 = 2.166 k $\Omega$ , R2 = 2.0 k $\Omega$ , RZ1 = 20 k $\Omega$ , RZ2 = 8.0  $\Omega$ , CP1 = 10 nF, CZ1 = 6.8 nF, CZ2 = 100 nF, RM1 = 2.166 k $\Omega$ , RM2 = 2.0 k $\Omega$ , RZM1 = 20 k $\Omega$ , RZM2 = 8.0  $\Omega$ , CPM1 = 10 nF, CZM1 = 6.8 nF, CZM2 = 100 nF for min/max values unless otherwise noted). Duplicate component values of MCH regulator from DDQ.

Characteristic	Symbol	Test Conditions	Min	Typ	Max	Unit
----------------	--------	-----------------	-----	-----	-----	------

## SUPPLY VOLTAGE

5VDUAL Operating Voltage	V5VDUAL		4.5	5.0	5.5	V
BOOT Operating Voltage	VBOOT			12.0	13.2	V

## SUPPLY CURRENT

S0 Mode Supply Current from 5VDUAL	I5VDL_S0	SLP_S5 = HIGH, SLP_S3 = HIGH, BOOT = 12 V, TG_1P5 and BG_1P5 Open			10	mA
S3 Mode Supply Current from 5VDUAL	I5VDL_S3	SLP_S5 = HIGH, SLP_S3 = LOW, TG_1P5 and BG_1P5 Open			5.0	mA
S5 Mode Supply Current from 5VDUAL	I5VDL_S5	SLP_S5 = LOW, BOOT = 0 V, TG_1P5 and BG_1P5 Open			1.0	mA
S0 Mode Supply Current from BOOT	IBOOT_S0	SLP_S5 = HIGH, SLP_S3 = HIGH, BOOT = 12 V, TG_1P5 and BG_1P5 Open			25	mA
S3 Mode Supply Current from BOOT	IBOOT_S3	SLP_S5 = HIGH, SLP_S3 = LOW, TG_1P5 and BG_1P5 Open			25	mA

## UNDERVOLTAGE-MONITOR

5VDUAL UVLO Upper Threshold	V5VDLUV+				4.4	V
5VDUAL UVLO Hysteresis	V5VDLhys		250	400	550	mV
BOOT UVLO Upper Threshold	VBOOTUV+				10.4	V
BOOT UVLO Hysteresis	VBOOThys			1.0		V

## THERMAL SHUTDOWN

Thermal Shutdown	Tsd	(Note 3)		145		$^\circ\text{C}$
Thermal Shutdown Hysteresis	Tsdhys	(Note 3)		25		$^\circ\text{C}$

## DDQ SWITCHING REGULATOR

FBDDQ Feedback Voltage, Control Loop in Regulation	VFBQ	$T_A = 25^\circ\text{C}$ $T_A = 0^\circ\text{C}$ to $70^\circ\text{C}$	1.178 1.166	1.190	1.202 1.214	V
Feedback Input Current	IDDQFB	V(FBDDQ) = 1.3 V			1.0	$\mu\text{A}$
Oscillator Frequency in S0 Mode	FDDQS0		217	250	283	KHz
Oscillator Frequency in S3 Mode	FDDQS3		434	500	566	KHz
Oscillator Ramp Amplitude	dVOSC	(Note 3)		1.3		Vp-p
Current Limit Blanking Time in S0 Mode	TDDQbk	(Note 3)	400			nS
Current Limit Threshold Offset from 5VDUAL	VOCP	(Note 3)	0.8			V
Minimum Duty Cycle	Dmin		0			%
Maximum Duty Cycle	Dmax				100	%
Soft-Start Pin Current for DDQ	Iss1	V(SS) = 0.5 V		4.0		$\mu\text{A}$

## DDQ ERROR AMPLIFIER

DC Gain	GAINDDQ	(Note 3)		70		dB
Gain-Bandwidth Product	GBWDDQ	COMP PIN to GND = 220 nF, 1.0 $\Omega$ in Series (Note 3)		12		MHz
Slew Rate	SRDDQ	COMP PIN TO GND = 10 pF		8.0		V/ $\mu\text{s}$

3. Guaranteed by design, not tested in production.

# NCP5220

**ELECTRICAL CHARACTERISTICS** (5VDUAL = 5.0 V, BOOT = 12 V, T<sub>A</sub> = 0°C to 70°C, L = 1.7 μH, COUT1 = 3770 μF, COUT2 = 470 μF, COUT3 = NA, CSS = 33 nF, R1 = 2.166 kΩ, R2 = 2.0 kΩ, RZ1 = 20 kΩ, RZ2 = 8.0 Ω, CP1 = 10 nF, CZ1 = 6.8 nF, CZ2 = 100 nF, RM1 = 2.166 kΩ, RM2 = 2.0 kΩ, RZM1 = 20 kΩ, RZM2 = 8.0 Ω, CPM1 = 10 nF, CZM1 = 6.8 nF, CZM2 = 100 nF for min/max values unless otherwise noted). Duplicate component values of MCH regulator from DDQ.

Characteristic	Symbol	Test Conditions	Min	Typ	Max	Unit
----------------	--------	-----------------	-----	-----	-----	------

## VTT ACTIVE TERMINATION REGULATOR

VTT tracking DDQ_REF/2 at S0 mode	DVTTS0	IOUT= 0 to 2.0 A (sink current) IOUT= 0 to -2.0 A (source current)	-30		30	mV
VTT Source Current Limit	ILIMVTrsrc		2.0			A
VTT Sink Current Limit	ILIMVTrsnk		2.0			A

## CONTROL SECTION

SLP_S5, SLP_S3 Input Logic HIGH	Logic_H		2.0			V
SLP_S5, SLP_S3 Input Logic LOW	Logic_L				0.8	V
SLP_S5, SLP_S3 Input Current	Ilogic				1.0	μA

## GATE DRIVERS

TGDDQ Gate Pull-HIGH Resistance	RH_TG	VCC = 12 V, V(TGDDQ) = 11.9 V		3.0		Ω
TGDDQ Gate Pull-LOW Resistance	RL_TG	VCC = 12 V, V(TGDDQ) = 0.1 V		2.5		Ω
BGDDQ Gate Pull-HIGH Resistance	RH_BG	VCC = 12 V, V(BGDDQ) = 11.9 V		3.0		Ω
BGDDQ Gate Pull-LOW Resistance	RL_BG	VCC = 12 V, V(BGDDQ) = 0.1 V		1.3		Ω
TG1P5 Gate Pull-HIGH Resistance	RH_TPG	VCC = 12 V, V(TG1P5) = 11.9 V		3.0		Ω
TG1P5 Gate Pull-LOW Resistance	RL_TPG	VCC = 12 V, V(TG1P5) = 0.1 V		2.5		Ω
BG1P5 Gate Pull-HIGH Resistance	RH_BPG	VCC = 12 V, V(BG1P5) = 11.9 V		3.0		Ω
BG1P5 Gate Pull-LOW Resistance	RL_BPG	VCC = 12 V, V(BG1P5) = 0.1 V		1.3		Ω

## MCH SWITCHING REGULATOR

VFB1P5 Feedback Voltage, Control Loo in Regulation	VFB1P5	T <sub>A</sub> = 0°C to 70°C	0.784	0.8	0.816	V
Feedback Input Current	I1P5FB				1.0	μA
Oscillator Frequency	F1P5		217	250	283	KHz
Oscillator Ramp Amplitude	dV1P5OSC	(Note 4)		1.3		Vp-p
Minimum Duty Cycle	Dmin_1P5		0			%
Maximum Duty Cycle	Dmax_1P5				100	%
Soft-Start Pin Current for V1P5 Regulator	ISS2	(Note 4)		8.0		μA

4. Guaranteed by design, not tested in production.

TYPICAL OPERATING CHARACTERISTICS

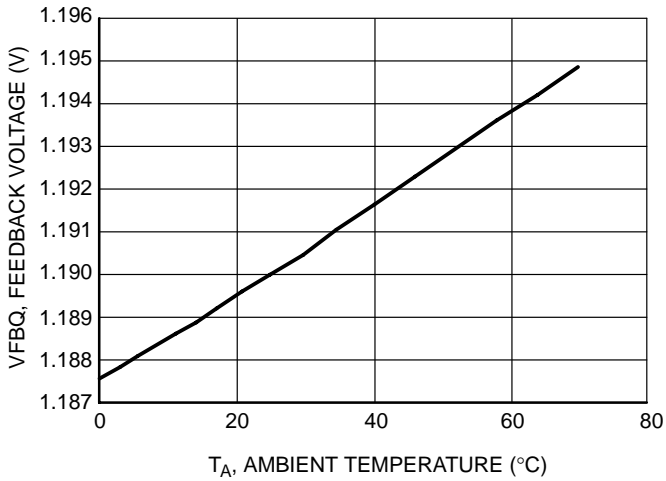

Figure 3. VFBQ Feedback Voltage vs. Ambient Temperature

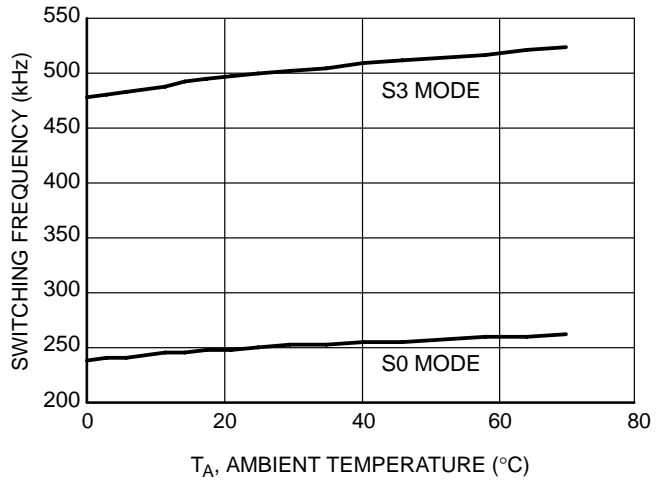

Figure 4. Oscillation Frequency in S0/S3 vs. Ambient Temperature

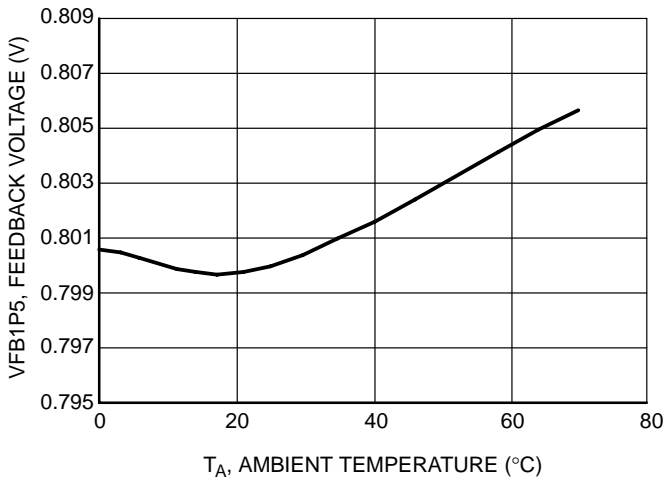

Figure 5. VFB1P5 Feedback Voltage vs. Ambient Temperature

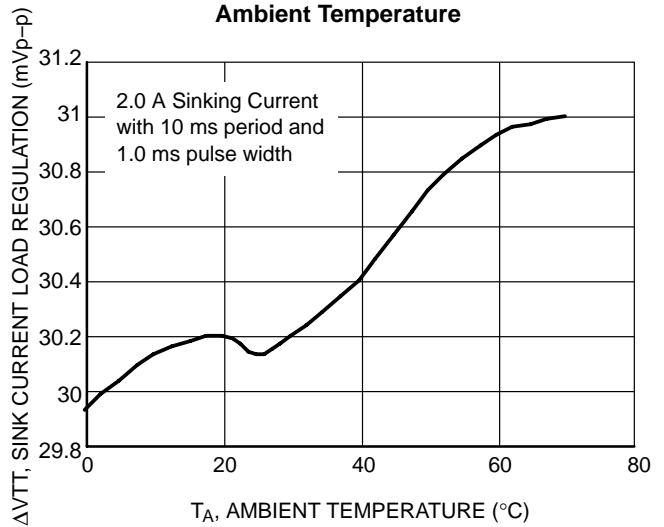

Figure 6. VTT Sink Current Load Regulation vs. Ambient Temperature

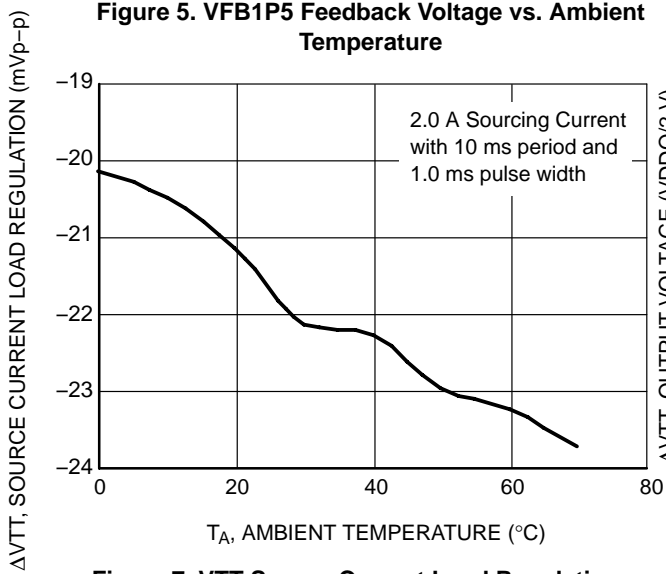

Figure 7. VTT Source Current Load Regulation vs. Ambient Temperature

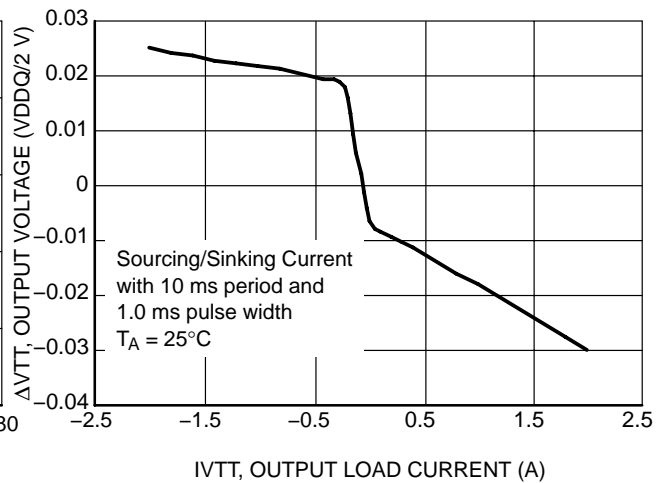
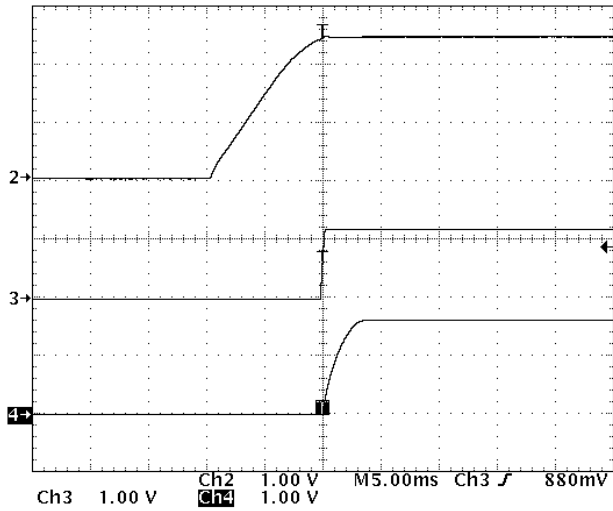

Figure 8. VTT, Output Voltage vs. Load Current

TYPICAL OPERATING WAVEFORMS



Channel 1: VDDQ Output Voltage, 1.0 V/div  
 Channel 2: VTT Output Voltage, 1.0 V/div  
 Channel 3: V1P5 Output Voltage, 1.0V/div  
 Time Base: 5.0 ms/div

Figure 9. Power-Up Sequence

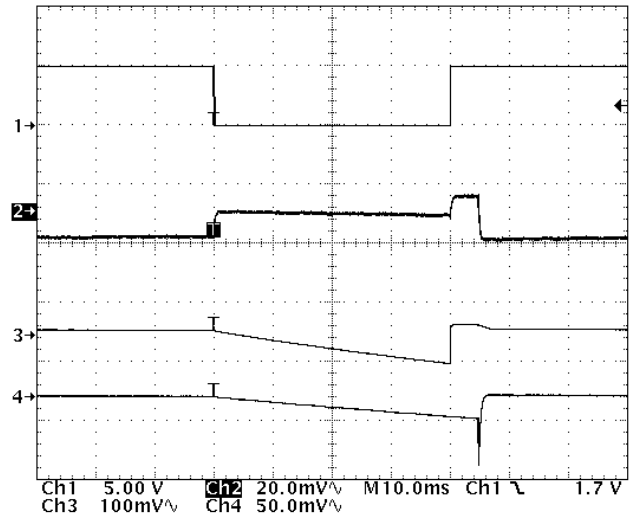

Channel 1: SLP\_S3 Pin Voltage, 5.0 V/div  
 Channel 2: VDDQ Output Voltage, AC-Coupled, 20 mV/div  
 Channel 3: VTT Output Voltage, AC-Coupled, 100 mV/div  
 Channel 4: V1P5 Output Voltage, 50 mV/div  
 Time Base: 10 ms/div

Figure 10. S0-S3-S0 Transition

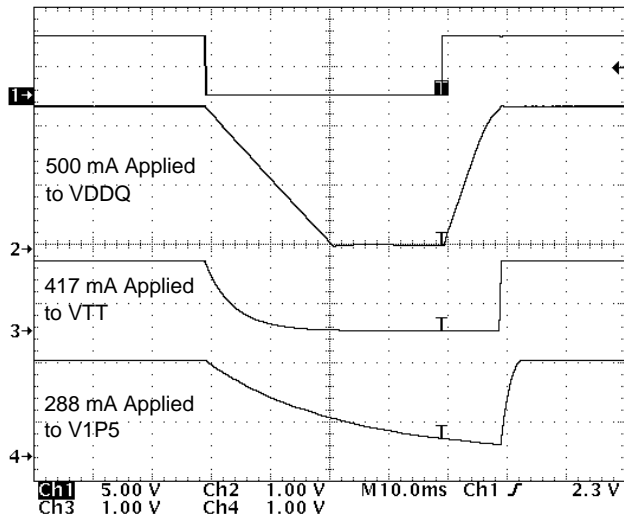

Channel 1: SLP\_S5 Pin Voltage, 5.0 V/div  
 Channel 2: VDDQ Output Voltage, 1.0 V/div  
 Channel 3: VTT Output Voltage, 1.0 V/div  
 Channel 4: V1P5 Output Voltage, 1.0 V/div  
 Time Base: 10 ms/div

Figure 11. S0-S5-S0 Transition

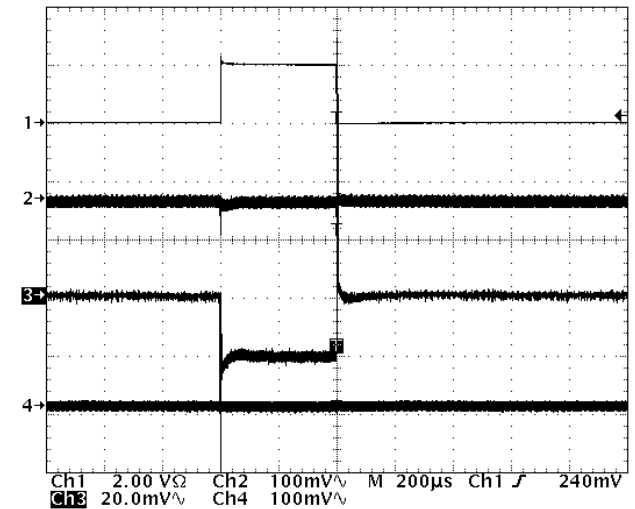

Channel 1: Current sourced out of VTT, 2.0 A/div  
 Channel 2: VDDQ Output Voltage, AC-Coupled, 100 mV/div  
 Channel 3: VTT Output Voltage, AC-Coupled, 20 mV/div  
 Channel 4: V1P5 Output Voltage, AC-Coupled, 100 mV/div  
 Time Base: 200 μs/div

Figure 12. VTT Source Current Transient,  
 0A-2A-0A



TYPICAL OPERATING WAVEFORMS

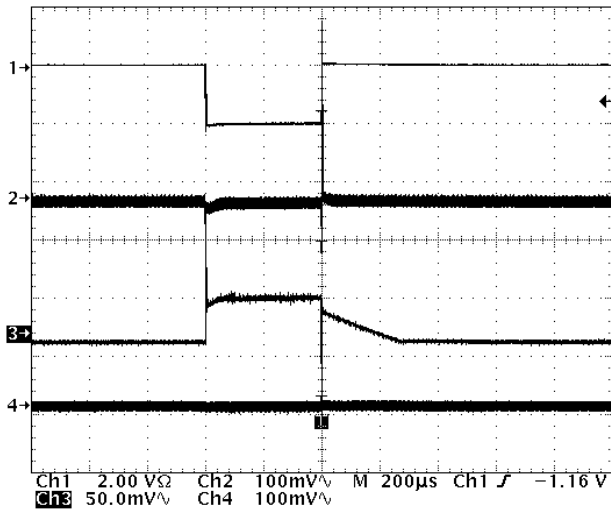

Channel 1: Current Sunk into VTT, 2.0 A/div  
 Channel 2: VDDQ output Voltage, AC-Coupled, 100 mV/div  
 Channel 3: VTT Output Voltage, AC-Coupled, 50 mV/div  
 Channel 4: V1P5 Output Voltage, AC-Coupled, 100 mV/div  
 Time Base: 200  $\mu$ s/div

**Figure 13. VTT Sink Current Transient,  
 0A-2A-0A**

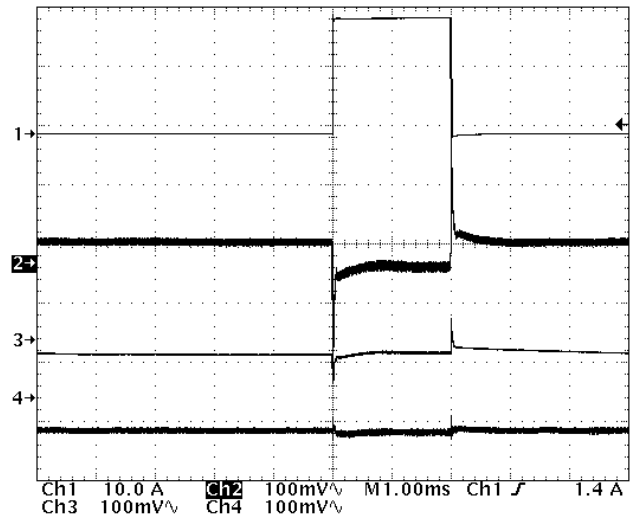

Channel 1: Current Sourced into V1P5, 10 A/div  
 Channel 2: VDDQ Output Voltage, AC-Coupled, 100 mV/div  
 Channel 3: VTT Output Voltage, AC-Coupled, 100 mV/div  
 V1P5 Output Voltage, AC-Coupled, 100 mV/div  
 Time Base: 1.0 ms/div

**Figure 14. VDDQ Source Current Transient,  
 0A-20A-0A**

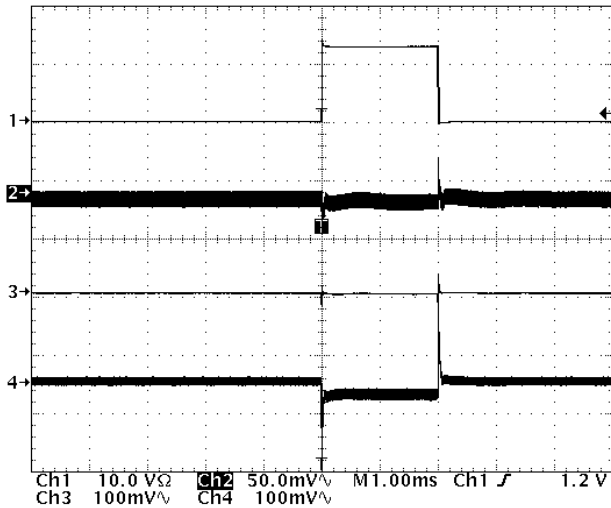

Channel 1: Current Sourced into VDDQ, 10 A/div  
 Channel 2: VDDQ Output Voltage, AC-Coupled, 50 mV/div  
 Channel 3: VTT Output Voltage, AC-Coupled, 100 mV/div  
 Channel 4: V1P5 Output Voltage, AC-Coupled, 100 mV/div  
 Time Base: 1.0 ms/div

**Figure 15. V1P5 Source Current Transient,  
 0A-12A-0A**

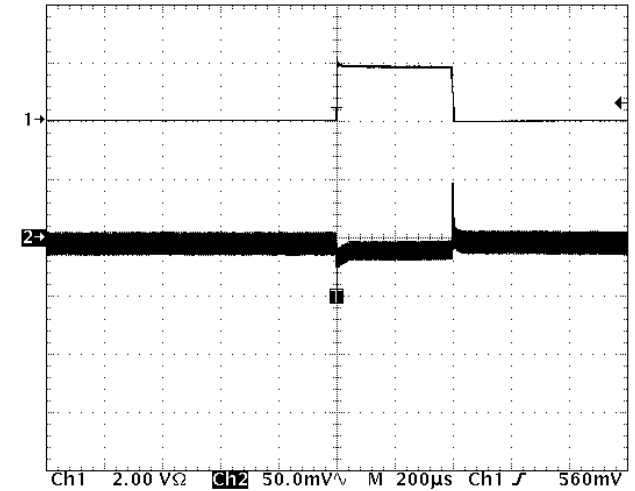

Channel 1: Current Sourced into VDDQ, 2.0 A/div  
 Channel 2: VDDQ Output Voltage, AC-Coupled, 50 mV/div  
 Time Base: 200  $\mu$ s/div

**Figure 16. S3 Mode without 12VATX,  
 0A-2A-0A**

## DETAILED OPERATION DESCRIPTIONS

**General**

The NCP5220 3-in-1 PWM Dual Buck Linear DDR Power Controller contains two high efficiency PWM controllers and an integrated two-quadrant linear regulator.

The VDDQ supply is produced by a PWM switching controller with two external N-Ch FETs. The VTT termination voltage is an integrated linear regulator with sourcing and sinking current capability which tracks at  $\frac{1}{2}$  VDDQ. The MCH core voltage is created by the secondary switching controller.

The inclusion of soft-start, supply undervoltage monitors and thermal shutdown, makes this device a total power solution for the MCH and DDR memory system. This device is packaged in a DFN-20.

**ACPI Control Logic**

The ACPI control logic is powered by the 5VDUAL supply. It accepts external control at the  $\overline{\text{SLP\_S3}}$  input and internal supply voltage monitoring signals from two UVLOs to decode the operating mode in accordance with the state transition diagram in Figure 18.

These UVLOs monitor the external supplies, 5VDUAL and 12VATX, through 5VDUAL and BOOT pins respectively. Two control signals,  $\_5\text{VDUALGD}$  and  $\_BOOTGD$ , are asserted when the supply voltages are good.

When the device is powered up initially, it is in the S5 shutdown mode to minimize the power consumption. When all three supply voltages are good with  $\overline{\text{SLP\_S3}}$  and  $\overline{\text{SLP\_S5}}$  remaining HIGH, the device enters the S0 normal operating mode. The transition of  $\overline{\text{SLP\_S3}}$  from HIGH to LOW while in the S0 mode, triggers the device into the S3 sleep mode. In S3 mode the 12VATX supply collapses. On transition of  $\overline{\text{SLP\_S3}}$  from LOW to HIGH, the device returns to S0 mode. The IC can re-enter S5 mode by setting  $\overline{\text{SLP\_S5}}$  LOW. A timing diagram is shown in Figure 17.

Table 1 summarizes the operating states of all the regulators, as well as the conditions of the output pins.

**Internal Bandgap Voltage Reference**

An internal bandgap reference is generated whenever 5VDUAL exceeds 2.7 V. Once this bandgap reference is in regulation, an internal signal  $\_V\text{REFGD}$  will be asserted.

**S5 to S0 Mode Power-Up Sequence**

The ACPI control logic is enabled by the assertion of  $\_V\text{REFGD}$ . Once the ACPI control is activated, the power-up sequence starts by waking up the 5VDUAL voltage monitor block. If the 5VDUAL supply is within the preset levels, the BOOT undervoltage monitor block is then enabled. After 12VATX is ready and the BOOT UVLO is asserted LOW, the ACPI control triggers this device from S5 shutdown mode into S0 normal operating mode by activating the soft-start of DDQ switching regulator, providing  $\overline{\text{SLP\_S3}}$  and  $\overline{\text{SLP\_S5}}$  remain HIGH.

Once the DDQ regulator is in regulation and the soft-start interval is completed, the  $\_In\text{RegDDQ}$  signal is asserted HIGH to enable the VTT regulator as well as the V1P5 switching regulator.

**DDQ Switching Regulator**

In S0 mode the DDQ regulator is a switching synchronous rectification buck controller driving two external power N-Ch FETs to supply up to 20 A. It employs voltage mode fixed frequency PWM control with external compensation switching at  $250\text{kHz} \pm 13.2\%$ . As shown in Figure 2, the VDDQ output voltage is divided down and fed back to the inverting input of an internal amplifier through the FBDDQ pin to close the loop at  $\text{VDDQ} = \text{VFBQ} \times (1 + \text{R1/R2})$ . This amplifier compares the feedback voltage with an internal reference voltage of 1.190 V to generate an error signal for the PWM comparator. This error signal is compared with a fixed frequency RAMP waveform derived from the internal oscillator to generate a pulse-width-modulated signal. This PWM signal drives the external N-Ch FETs via the TG\_DDQ and BG\_DDQ pins. External inductor L and capacitor COUT1 filter the output waveform. When the IC leaves the S5 state, the VDDQ output voltage ramps up at a soft-start rate controlled by the capacitor at the SS pin. When the regulation of VDDQ is detected in S0 mode,  $\_IN\text{REGDDQ}$  goes HIGH to notify the control block.

In S3 standby mode, the switching frequency is doubled to reduce the conduction loss in the external N-Ch FETs.

**Table 1. Mode, Operation and Output Pin Conditions**

MODE	OPERATING CONDITIONS			OUTPUT PIN CONDITIONS			
	DDQ	VTT	MCH	TG_DDQ	BG_DDQ	TP_1P5	BG_1P5
S0	Normal	Normal	Normal	Normal	Normal	Normal	Normal
S3	Standby	H-Z	OFF	Standby	Standby	Low	Low
S5	OFF	H-Z	OFF	Low	Low	Low	Low

For enhanced efficiency, an active synchronous switch is used to eliminate the conduction loss contributed by the forward voltage of a diode or Schottky diode rectifier. Adaptive non-overlap timing control of the complementary gate drive output signals is provided to reduce shoot-through current that degrades efficiency.

### Tolerance of VDDQ

Both the tolerance of VFBQ and the ratio of the external resistor divider R1/R2 impact the precision of VDDQ. With the control loop in regulation,  $VDDQ = VFBQ \times (1 + R1/R2)$ . With a worst case (for all valid operating conditions) VFBQ tolerance of  $\pm 1.5\%$ , a worst case range of  $\pm 2\%$  for VDDQ will be assured if the ratio R1/R2 is specified as  $1.100 \pm 1\%$ .

### Fault Protection of VDDQ Regulator

In S0 mode, an internal voltage (VOCP) =  $5VDUAL - 0.8$  sets the current limit for the high-side switch. The voltage V MCP pin is compared to the voltage at SWDDQ pin when the high-side gate drive is turned on after a fixed period of blanking time to avoid false current limit triggering. When the voltage at SWDDQ is lower than VOCP, an overcurrent condition occurs and all regulators are latched off to protect against overcurrent. The IC will be powered up again if one of the supply voltages, 5VDUAL,  $\overline{SLP\_S5}$  or 12VATX, is recycled. The main purpose is for fault protection, not for precise current limit.

In S3 mode, this overcurrent protection feature is disabled.

### Feedback Compensation of VDDQ Regulator

The compensation network is shown in Figure 2.

### VTT Active Terminator

The VTT active terminator is a 2 quadrant linear regulator with two internal N-Ch FETs to provide current sink and source capability up to 2.0 A. It is activated only when the DDQ regulator is in regulation in S0 mode. It draws power from VDDQ with the internal gate drive power derived from 5VDUAL. While VTT output is connecting to the FBVTT

pin directly, VTT voltage is designed to automatically track at the half of VDDQ. This regulator is stable with any value of output capacitor greater than 470  $\mu$ F, and is insensitive to ESR ranging from 1 m $\Omega$  to 400 m $\Omega$ .

### Fault Protection of VTT Active Terminator

To provide protection for the internal FETs, bi-directional current limit preset at 2.4 A magnitude is implemented. The VTT provides a soft-start function during start up.

### MCH Switching Regulator

The secondary switching regulator is identical to the DDQ regulator except the output is 10 A. No fault protection is implemented and the soft-start timing is twice as fast with respect to CSS.

### BOOT Pin Supply Voltage

In typical application, a flying capacitor is connected between SWDDQ and BOOT pins. In S0 mode, 12VATX is tied to BOOT pin through a Schottky diode as well. A 13 V Zener clamp circuit must clamp this boot strapping voltage produced by the flying capacitor in S0 mode.

In S3 mode the 12VATX is collapsed and the BOOT voltage is created by the Schottky diode between 5VDUAL and BOOT pins as well as the flying capacitor. The BOOT\_UVLO works specially. The \_BOOTGD goes low and the IC remains in S3 mode.

### Thermal Consideration

Assuming an ambient temperature of 50°C, the maximum allowed dissipated power of DFN-20 is 2.8 W, which is enough to handle the internal power dissipation in S0 mode.

**To take full advantage of the thermal capability of this package, the exposed pad underneath must be soldered directly onto a PCB metal substrate to allow good thermal contact.**

### Thermal Shutdown

When the junction temperature of the IC exceeds 145°C, the entire IC is shutdown. When the junction temperature drops below 120°C, the chip resumes normal operation.

## NCP5220

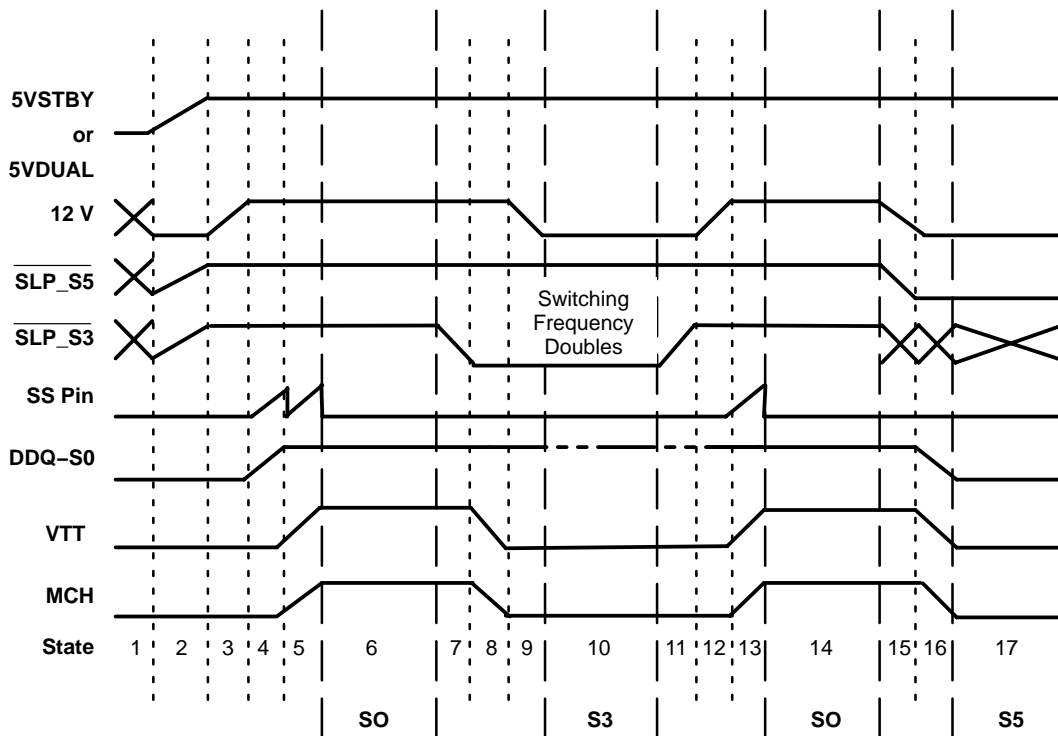

2. 5VSTBY or 5VSTB is the ultimate chip enable,  $\overline{\text{SLP\_S5}}$  and  $\overline{\text{SLP\_S3}}$  go HIGH. This supply has to be up first to ensure gates are in known state.
3. 12 V supply ramp.
4. DDQ will ramp with the tracking of SS pin, timing is  $1.2 * C_{SS} / 4 \mu$  (sec).
5. DDQ SS is completed, then SS pin is released from DDQ. SS pin is shorted to ground.
6. MCH ramps with the tracking of SS pin ramp, timing is  $0.8 * C_{SS} / 8 \mu$  (sec). VTT start up with current limit.
7. S3 MODE --  $\overline{\text{SLP\_S3}} = \text{L}$ .
8. VTT and MCH will be turned off.
9. 12 V ramps to 0 V.
10. Standard S3 State.
11.  $\overline{\text{SLP\_S3}}$  goes HIGH.
12. 12 V ramps back to regulation.
13. 12 V UVLO = L and  $\overline{\text{SLP\_S3}} = \text{H}$ . MCH ramps with SS pin, timing is  $0.8 * C_{SS} / 8 \mu$  (sec). VTT rises.
14. S0 Mode.
15. S5 Mode --  $\overline{\text{SLP\_S5}} = \text{L}$ .
16. DDQ, VTT and MCH Turned OFF.
17. S5 Mode.

**Figure 17. NCP5220 Power-Up and Power-Down**

# NCP5220

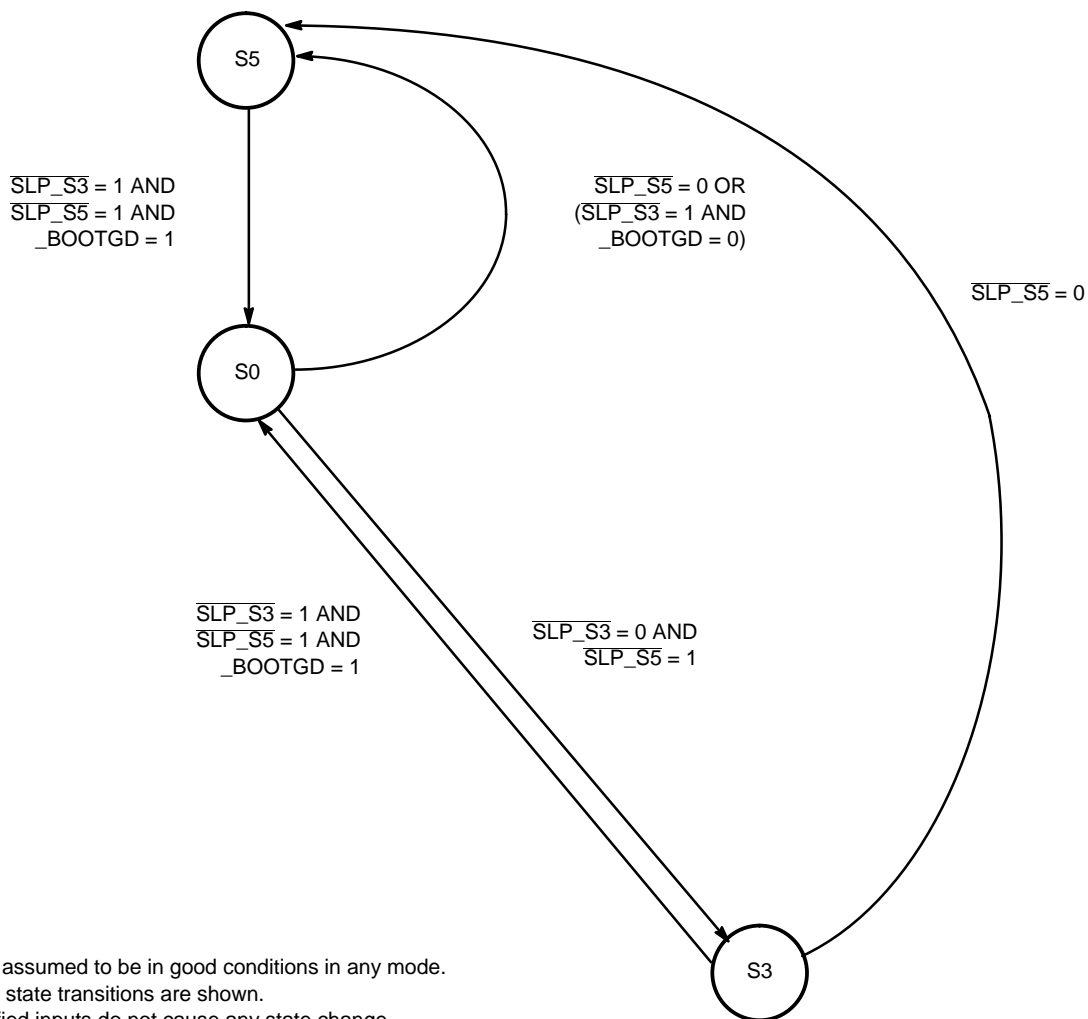

NOTE: 5VDUAL is assumed to be in good conditions in any mode.  
 All possible state transitions are shown.  
 All unspecified inputs do not cause any state change.

**Figure 18. Transitions State Diagram of NCP5220**

APPLICATION INFORMATION

Application Circuit

Figure 20, on the following page, shows the typical application circuit for NCP5220. The NCP5220 is specifically designed as a total power solution for the MCH and DDR memory system. This diagram contains NCP5220 for driving four external N-Ch FETs to form the DDR memory supply voltage (VDDQ) and the MCH regulator.

Output Inductor Selection

The value of the output inductor is chosen by balancing ripple current with transient response capability. A value of 1.7  $\mu\text{H}$  will yield about 3.0 A peak-peak ripple current when converting from 5.0 V to 2.5 V at 250 kHz. It is important that the rated inductor current is not exceeded during full load, and that the saturation current is not less than the expected peak current. Low ESR inductors may be required to minimize DC losses and temperature rise.

Input Capacitor Selection

Input capacitors for PWM power supplies are required to provide a stable, low impedance source node for the buck regulator to convert from. The usual practice is to use a combination of electrolytic capacitors and multi-layer ceramic capacitors to provide bulk capacitance and high frequency noise suppression. It is important that the capacitors are rated to handle the AC ripple current at the input of the buck regulators, as well as the input voltage. In the NCP5220 the DDQ and MCH regulators are interleaved (out of phase by 180 degrees) to reduce the peak AC input current.

Output Capacitor Selection

Output capacitors are chosen by balancing the cost with the requirements for low output ripple voltage and transient voltage. Low ESR electrolytic capacitors can be effective at reducing ripple voltage at 250 kHz. Low ESR ceramic capacitors are most effective at reducing output voltage excursions caused by fast load steps of system memory and the memory controller.

Power MOSFET Selection

Power MOSFETs are chosen by balancing the cost with the requirements for the current load of the memory system and the efficiency of the converter provided. The selections criteria can be based on drain-source voltage, drain current, on-resistance  $R_{DS(on)}$  and input gate capacitance. Low  $R_{DS(on)}$  and high drain current power MOSFETs are usually preferred to achieve the high current requirement of the DDR memory system and MCH, as well as the high efficiency of the converter. The tradeoff is a corresponding increase in the input gate capacitor of the power MOSFETs.

PCB Layout Considerations

With careful PCB layout the NCP5220 can supply 20 A or more of current. It is very important to use wide traces or large copper shapes to carry current from the input node through the MOSFET switches, inductor and to the output filters and load. Reducing the length of high current nodes will reduce losses and reduce parasitic inductance. It is usually best to locate the input capacitors the MOSFET switches and the output inductor in close proximity to reduce DC losses, parasitic inductance losses and radiated EMI.

The sensitive voltage feedback and compensation networks should be placed near the NCP5220 and away from the switch nodes and other noisy circuit elements. Placing compensation components near each other will minimize the loop area and further reduce noise susceptibility.

Optional Boost Voltage Configuration

The charge pump circuit in Figure 19 can be used instead of boost voltage scheme of Figure 20. The advantage in Figure 19 is the elimination of the requirement for the Zener clamp.

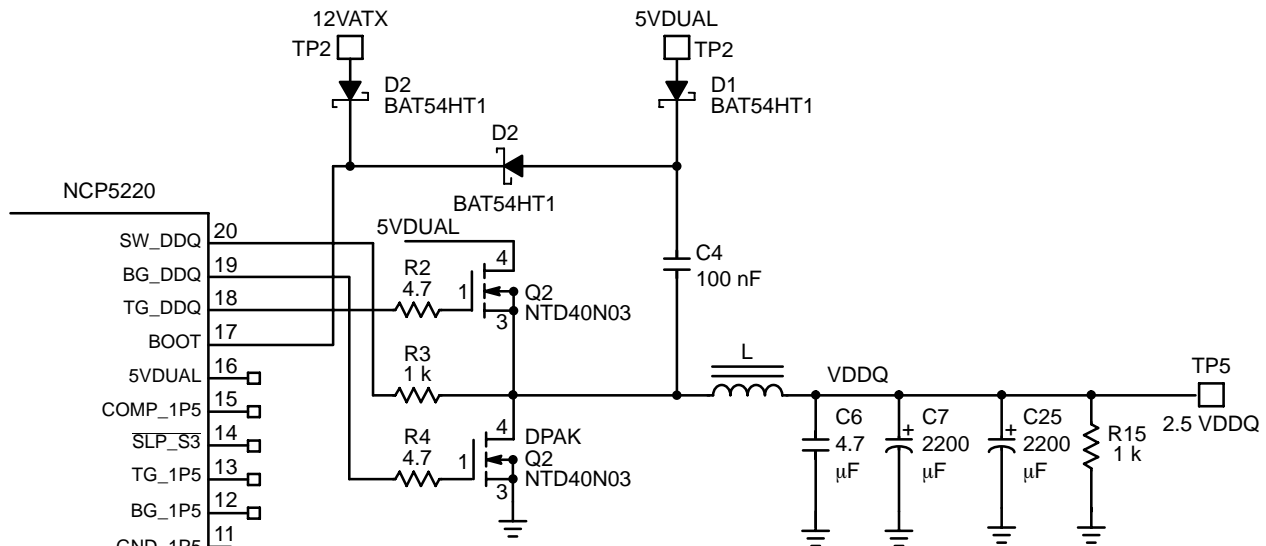

Figure 19. Charge Pump Circuit at BOOT Pin



# NCP5220

**Table 2. Bill of Material of NCP5220 Application Circuit**

Reference Design	Description	Value	Qty	Part Number	Manufacturer
Q1, Q2	Power MOSFET N-Channel	24 V, 4.8 mΩ, 85 A	2	NTD85N02R	ON Semiconductor
Q3, Q4	Power MOSFET N-Channel	25 V, 12.6 mΩ, 40 A	2	NTD40N03R	ON Semiconductor
D1, D2	Rectifier Schottky Diode	30 V	2	BAT54HT1	ON Semiconductor
U1	Controller	3-in-1 PWM Dual Buck and Linear Power Controller	1	NCP5220	ON Semiconductor
Zener	Zener Diode	13 V, 0.5 W	1	MMSZ13T1	ON Semiconductor
L1	Toroidal Choke	1.0 μH, 25 A	1	T60-26(6T)	
L2, L3	Toroidal Choke	1.8 μH, 25 A	2	T50-26B(6T)	
C2, C3	Aluminum Electrolytic Capacitor	3300 μF, 6.3 V	2	EEUFJ0J332U	Panasonic
C5	Aluminum Electrolytic Capacitor	470 μF, 35 V	1	EEUFC1V471	Panasonic
C21	Aluminum Electrolytic Capacitor	100 μF, 50 V	1	EEUFC1H101	Panasonic
C20	Aluminum Electrolytic Capacitor	470 μF, 16 V	1	EEUFC1C471	Panasonic
C13, C24	Aluminum Electrolytic Capacitor	470 μF, 10 V	2	EEUFC1A471	Panasonic
C7, C25, C15, C26	Aluminum Electrolytic Capacitor	2200 μF, 6.3 V	4	EEUFC0J222S(H)	Panasonic
C11	Ceramic Capacitor	220 nF, 10 V	1	ECJ1VB1A224K	Panasonic
C6, C12, C14	Ceramic Capacitor	4.7 μF, 6.3 V	3	ECJHVB0J475M	Panasonic
C22, C23	Ceramic Capacitor	10 μF, 25 V	2	ECJ4YB1E106M	Panasonic
C4	Ceramic Capacitor	22 nF, 25 V	1	ECJ1VB1E223K	Panasonic
C10, C17	Ceramic Capacitor	6.8 nF, 50 V	2	ECJ1VB1H682K	Panasonic
C9, C18	Ceramic Capacitor	100 nF, 16 V	2	ECJ1VB1C104K	Panasonic
C8, C16	Ceramic Capacitor	10 nF, 50 V	2	ECJ1VB1H103K	Panasonic
C1	Ceramic Capacitor	33 nF, 25 V	1	ECJ1VB1E333K	Panasonic
R2	Resistor	2.2 Ω	1		
R4	Resistor	1.0 Ω	1		
R9, R10	Resistor	4.7 Ω	2		
R3, R15, R16, R17	Resistor	1.0 kΩ	4		
R7, R12	Resistor	20 kΩ	2		
R6, R13	Resistor	8.2 Ω	2		
R8, R14	Resistor	2.0 kΩ	2		
R5, R11	Resistor	2.2 kΩ	2		
R18	Resistor	51 kΩ	1		



# MECHANICAL CASE OUTLINE

## PACKAGE DIMENSIONS

ON Semiconductor®

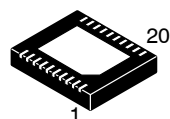

DFN20, 6x5, 0.5P  
CASE 505AB  
ISSUE C

DATE 23 MAY 2012

SCALE 2:1

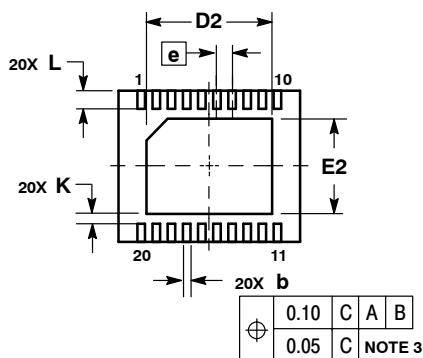
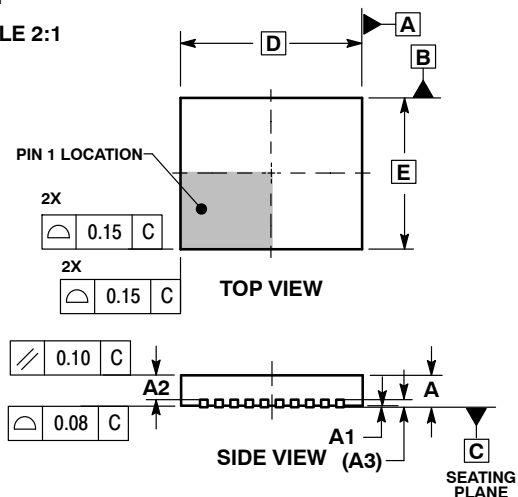

### RECOMMENDED SOLDERING FOOTPRINT\*

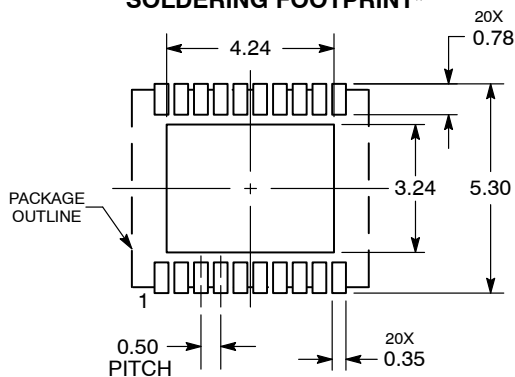

\*For additional information on our Pb-Free strategy and soldering details, please download the ON Semiconductor Soldering and Mounting Techniques Reference Manual, SOLDERRM/D.

#### NOTES:

1. DIMENSIONS AND TOLERANCING PER ASME Y14.5M, 1994.
2. DIMENSIONS IN MILLIMETERS.
3. DIMENSION b APPLIES TO PLATED TERMINALS AND IS MEASURED BETWEEN 0.25 AND 0.30 MM FROM TERMINAL COPLANARITY APPLIES TO THE EXPOSED PAD AS WELL AS THE TERMINALS.
4. COPPLANARITY APPLIES TO THE EXPOSED PAD AS WELL AS THE TERMINALS.
5. FOR DEVICE OPN CONTAINING W OPTION, DETAIL B ALTERNATE CONSTRUCTION IS NOT APPLICABLE.

MILLIMETERS		
DIM	MIN	MAX
A	0.80	1.00
A1	0.00	0.05
A2	0.65	0.75
A3	0.20	REF
b	0.20	0.30
D	6.00 BSC	
D2	3.98	4.28
E	5.00 BSC	
E2	2.98	3.28
e	0.50 BSC	
K	0.20	---
L	0.50	0.60

### GENERIC MARKING DIAGRAM\*

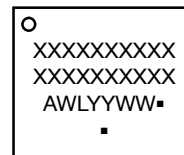

- XXXXX = Specific Device Code
- A = Assembly Location
- WL = Wafer Lot
- YY = Year
- WW = Work Week
- = Pb-Free Package

(Note: Microdot may be in either location)

\*This information is generic. Please refer to device data sheet for actual part marking. Pb-Free indicator, "G" or microdot "▪", may or may not be present.

<b>DOCUMENT NUMBER:</b>	<b>98AON13117D</b>	Electronic versions are uncontrolled except when accessed directly from the Document Repository. Printed versions are uncontrolled except when stamped "CONTROLLED COPY" in red.
<b>DESCRIPTION:</b>	<b>20 PIN DFN, 6X5 MM, 0.5 MM PITCH</b>	<b>PAGE 1 OF 1</b>

ON Semiconductor and ON are trademarks of Semiconductor Components Industries, LLC dba ON Semiconductor or its subsidiaries in the United States and/or other countries. ON Semiconductor reserves the right to make changes without further notice to any products herein. ON Semiconductor makes no warranty, representation or guarantee regarding the suitability of its products for any particular purpose, nor does ON Semiconductor assume any liability arising out of the application or use of any product or circuit, and specifically disclaims any and all liability, including without limitation special, consequential or incidental damages. ON Semiconductor does not convey any license under its patent rights nor the rights of others.

**onsemi**, **Onsemi**, and other names, marks, and brands are registered and/or common law trademarks of Semiconductor Components Industries, LLC dba "**onsemi**" or its affiliates and/or subsidiaries in the United States and/or other countries. **onsemi** owns the rights to a number of patents, trademarks, copyrights, trade secrets, and other intellectual property. A listing of **onsemi**'s product/patent coverage may be accessed at [www.onsemi.com/site/pdf/Patent-Marking.pdf](http://www.onsemi.com/site/pdf/Patent-Marking.pdf). **onsemi** reserves the right to make changes at any time to any products or information herein, without notice. The information herein is provided "as-is" and **onsemi** makes no warranty, representation or guarantee regarding the accuracy of the information, product features, availability, functionality, or suitability of its products for any particular purpose, nor does **onsemi** assume any liability arising out of the application or use of any product or circuit, and specifically disclaims any and all liability, including without limitation special, consequential or incidental damages. Buyer is responsible for its products and applications using **onsemi** products, including compliance with all laws, regulations and safety requirements or standards, regardless of any support or applications information provided by **onsemi**. "Typical" parameters which may be provided in **onsemi** data sheets and/or specifications can and do vary in different applications and actual performance may vary over time. All operating parameters, including "Typicals" must be validated for each customer application by customer's technical experts. **onsemi** does not convey any license under any of its intellectual property rights nor the rights of others. **onsemi** products are not designed, intended, or authorized for use as a critical component in life support systems or any FDA Class 3 medical devices or medical devices with a same or similar classification in a foreign jurisdiction or any devices intended for implantation in the human body. Should Buyer purchase or use **onsemi** products for any such unintended or unauthorized application, Buyer shall indemnify and hold **onsemi** and its officers, employees, subsidiaries, affiliates, and distributors harmless against all claims, costs, damages, and expenses, and reasonable attorney fees arising out of, directly or indirectly, any claim of personal injury or death associated with such unintended or unauthorized use, even if such claim alleges that **onsemi** was negligent regarding the design or manufacture of the part. **onsemi** is an Equal Opportunity/Affirmative Action Employer. This literature is subject to all applicable copyright laws and is not for resale in any manner.

## ADDITIONAL INFORMATION

### TECHNICAL PUBLICATIONS:

Technical Library: [www.onsemi.com/design/resources/technical-documentation](http://www.onsemi.com/design/resources/technical-documentation)  
onsemi Website: [www.onsemi.com](http://www.onsemi.com)

### ONLINE SUPPORT: [www.onsemi.com/support](http://www.onsemi.com/support)

For additional information, please contact your local Sales Representative at [www.onsemi.com/support/sales](http://www.onsemi.com/support/sales)