

NCP4620

150 mA, 10 V, Low Dropout Regulator

The NCP4620 is a CMOS Linear voltage regulator with 150 mA output current capability. The device is capable of operating with input voltages up to 10 V, with high output voltage accuracy and low temperature–drift coefficient. The NCP4620 is easy to use, with output current fold–back protection and a thermal shutdown circuit included. A Chip Enable function is included to save power by lowering supply current.

Features

- Operating Input Voltage Range: 2.6 V to 10 V
- Output Voltage Range: 1.2 V to 6.0 V (available in 0.1 V steps)
- Output Voltage Accuracy: $\pm 1.0\%$
- Low Supply Current: 23 μA
- Low Dropout: 165 mV ($I_{\text{OUT}} = 100 \text{ mA}$, $V_{\text{OUT}} = 3.3 \text{ V}$)
400 mV ($I_{\text{OUT}} = 150 \text{ mA}$, $V_{\text{OUT}} = 2.8 \text{ V}$)
- High PSRR: 70 dB at 1 kHz
- Line Regulation 0.02%/V Typ
- Current Fold Back Protection
- Thermal Shutdown Protection
- Stable with Ceramic Capacitors
- Available in SC–70 and SOT23 Packages
- These are Pb–Free Devices*

Typical Applications

- Battery products powered by 2 Lithium Ion cells
- Networking and Communication Equipment
- Cameras, DVRs, STB and Camcorders
- Toys, industrial applications

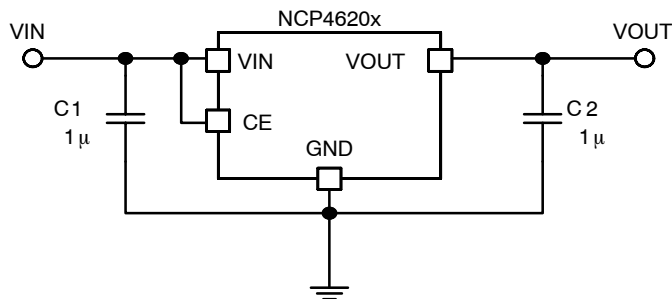

Figure 1. Typical Application Schematic

*For additional information on our Pb–Free strategy and soldering details, please download the ON Semiconductor Soldering and Mounting Techniques Reference Manual, SOLDERRM/D.



ON Semiconductor™

<http://onsemi.com>

MARKING DIAGRAMS



SC–70
CASE 419A

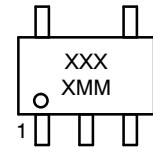

SOT–23–5
CASE 1212

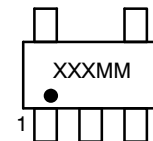

XXXX, XXX= Specific Device Code
MM = Date Code

ORDERING INFORMATION

See detailed ordering and shipping information in the package dimensions section on page 14 of this data sheet.

NCP4620

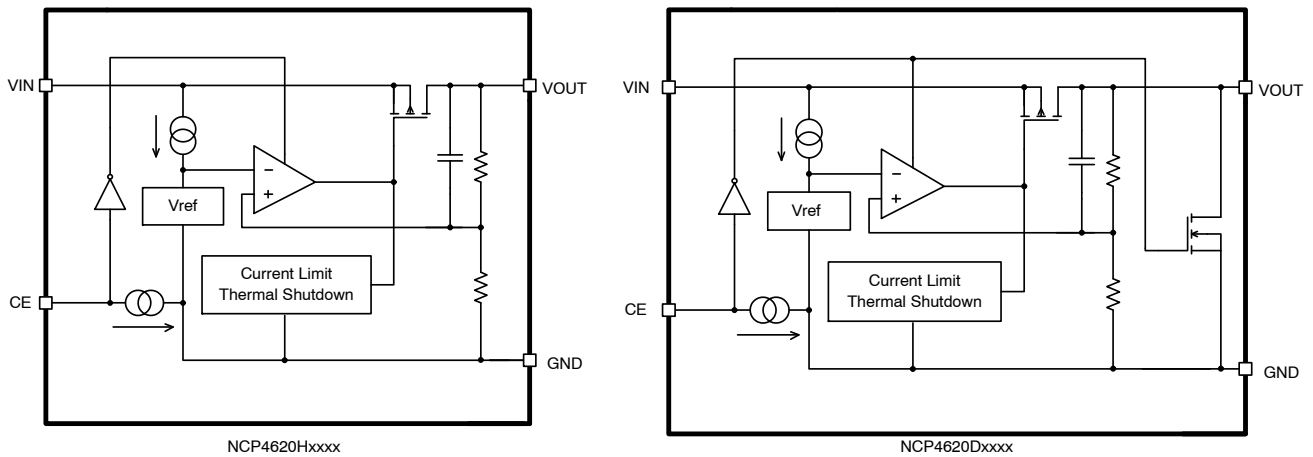

Figure 2. Simplified Schematic Block Diagram

PIN FUNCTION DESCRIPTION

Pin No. SC-70	Pin No. SOT23	Pin Name	Description
5	1	VIN	Input pin
3	2	GND	Ground
1	3	CE	Chip enable pin (Active "H")
4	5	VOUT	Output pin
2	4	NC	No connection

ABSOLUTE MAXIMUM RATINGS

Rating	Symbol	Value	Unit
Input Voltage (Note 1)	V_{IN}	12.0	V
Output Voltage	V_{OUT}	-0.3 to $V_{IN} + 0.3$	V
Chip Enable Input	V_{CE}	12.0	V
Output Current	I_{OUT}	165	mA
Power Dissipation - SC-70	P_D	380	mW
Power Dissipation - SOT23		420	
Operating Temperature	T_A	-40 to +85	°C
Maximum Junction Temperature	T_J	+150	°C
Storage Temperature	T_{STG}	-55 to +125	°C
ESD Capability, Human Body Model (Note 2)	ESD_{HBM}	2000	V
ESD Capability, Machine Model (Note 2)	ESD_{MM}	200	V

Stresses exceeding Maximum Ratings may damage the device. Maximum Ratings are stress ratings only. Functional operation above the Recommended Operating Conditions is not implied. Extended exposure to stresses above the Recommended Operating Conditions may affect device reliability.

- Refer to ELECTRICAL CHARACTERISTICS and APPLICATION INFORMATION for Safe Operating Area.
- This device series incorporates ESD protection and is tested by the following methods:
 ESD Human Body Model tested per AEC-Q100-002 (EIA/JESD22-A114)
 ESD Machine Model tested per AEC-Q100-003 (EIA/JESD22-A115)
 Latchup Current Maximum Rating tested per JEDEC standard: JESD78.

NCP4620

THERMAL CHARACTERISTICS

Rating	Symbol	Value	Unit
Thermal Characteristics, SOT23 Thermal Resistance, Junction-to-Air	$R_{\theta JA}$	238	$^{\circ}\text{C}/\text{W}$
Thermal Characteristics, SC-70 Thermal Resistance, Junction-to-Air	$R_{\theta JA}$	263	$^{\circ}\text{C}/\text{W}$

ELECTRICAL CHARACTERISTICS $-40^{\circ}\text{C} \leq T_A \leq 85^{\circ}\text{C}$; $V_{IN} = V_{OUT(NOM)} + 1\text{ V}$; $I_{OUT} = 1\text{ mA}$, $C_{IN} = C_{OUT} = 0.47\text{ }\mu\text{F}$, unless otherwise noted. Typical values are at $T_A = +25^{\circ}\text{C}$.

Parameter	Test Conditions		Symbol	Min	Typ	Max	Unit
Operating Input Voltage			V_{IN}	2.6		10	V
Output Voltage	$T_A = +25^{\circ}\text{C}$	$V_{OUT} > 1.5\text{ V}$ $V_{OUT} \leq 1.5\text{ V}$	V_{OUT}	x0.99 -15		x1.01 15	V mV
	$-40^{\circ}\text{C} \leq T_A \leq 85^{\circ}\text{C}$	$V_{OUT} > 1.5\text{ V}$ $V_{OUT} \leq 1.5\text{ V}$		x0.974 -40		x1.023 35	V mV
Output Voltage Temp. Coefficient	$-40^{\circ}\text{C} \leq T_A \leq 85^{\circ}\text{C}$				± 80		ppm/ $^{\circ}\text{C}$
Line Regulation	$V_{OUT(NOM)} + 0.5\text{ V}$ or 2.6 V (whichever is higher) $\leq V_{IN} \leq 10\text{ V}$		LineReg		0.02	0.2	%/V
Load Regulation	$I_{OUT} = 0.1\text{ mA}$ to 150 mA		LoadReg		5	40	mV
Dropout Voltage	$I_{OUT} = 150\text{ mA}$	$1.2\text{ V} \leq V_{OUT} < 1.3\text{ V}$	V_{DO}			1.40	V
		$1.3\text{ V} \leq V_{OUT} < 1.5\text{ V}$				1.30	
		$1.5\text{ V} \leq V_{OUT} < 1.8\text{ V}$				1.10	
		$1.8\text{ V} \leq V_{OUT} < 2.3\text{ V}$				0.80	
		$2.3\text{ V} \leq V_{OUT} < 3.0\text{ V}$			0.40	0.58	
		$3.0\text{ V} \leq V_{OUT} < 4.0\text{ V}$			0.30	0.48	
		$4.0\text{ V} \leq V_{OUT} < 6.0\text{ V}$			0.25	0.40	
Output Current			I_{OUT}	150			mA
Short Current Limit	$V_{OUT} = 0\text{ V}$		I_{SC}		40		mA
Quiescent Current			I_Q		23	40	μA
Standby Current	$V_{IN} = 10\text{ V}$, $V_{CE} = 0\text{ V}$, $T_A = 25^{\circ}\text{C}$		I_{STB}		0.1	1.0	μA
CE Pin Threshold Voltage	CE Input Voltage "H"		V_{CEH}	1.7			V
	CE Input Voltage "L"		V_{CEL}			0.8	
CE Pull Down Current			I_{CEPD}		0.3		μA
Power Supply Rejection Ratio	$V_{IN} = V_{OUT} + 1\text{ V}$ or 3.0 V whichever is higher, $\Delta V_{IN} = 0.2\text{ V}_{pk-pk}$, $I_{OUT} = 30\text{ mA}$, $f = 1\text{ kHz}$		PSRR		70		dB
Output Noise Voltage	$f = 10\text{ Hz}$ to 100 kHz , $I_{OUT} = 30\text{ mA}$, $V_{OUT} = 1.5\text{ V}$, $V_{IN} = 2.6\text{ V}$		V_N		90		μV_{rms}
Low Output N-ch Tr. On Resistance	$V_{IN} = 7\text{ V}$, $V_{CE} = 0\text{ V}$		R_{LOW}		250		Ω
Thermal Shutdown Temperature			T_{TSD}		165		$^{\circ}\text{C}$
Thermal Shutdown Release			T_{TSR}		110		$^{\circ}\text{C}$

NCP4620

TYPICAL CHARACTERISTICS

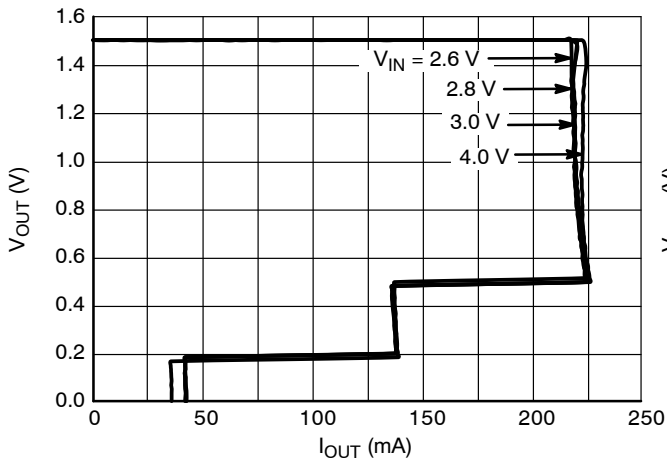

**Figure 3. Output Voltage vs. Output Current
1.5 V Version ($T_J = 25^\circ\text{C}$)**

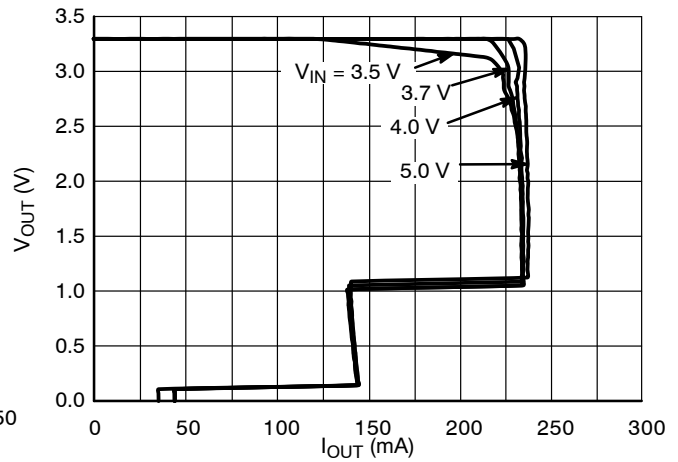

**Figure 4. Output Voltage vs. Output Current
3.3 V Version ($T_J = 25^\circ\text{C}$)**

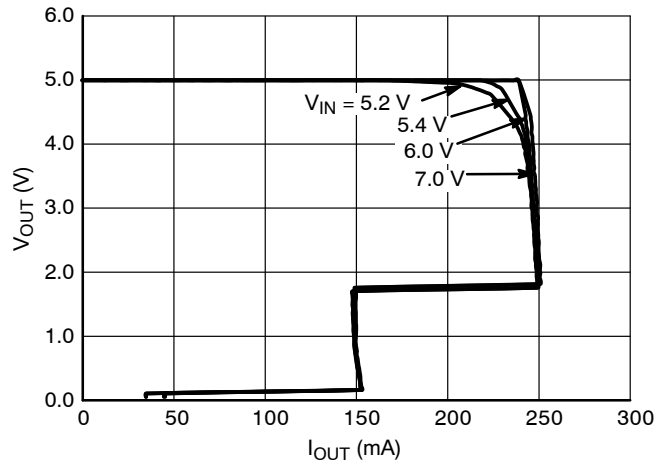

**Figure 5. Output Voltage vs. Output Current
5.0 V Version ($T_J = 25^\circ\text{C}$)**

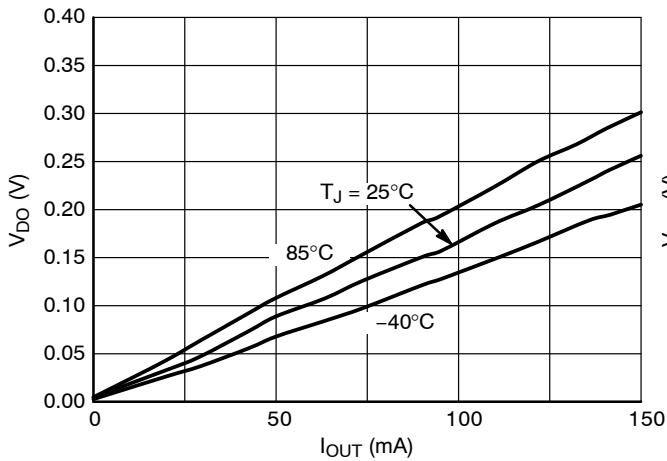

**Figure 6. Dropout Voltage vs. Output Current
3.3 V Version**

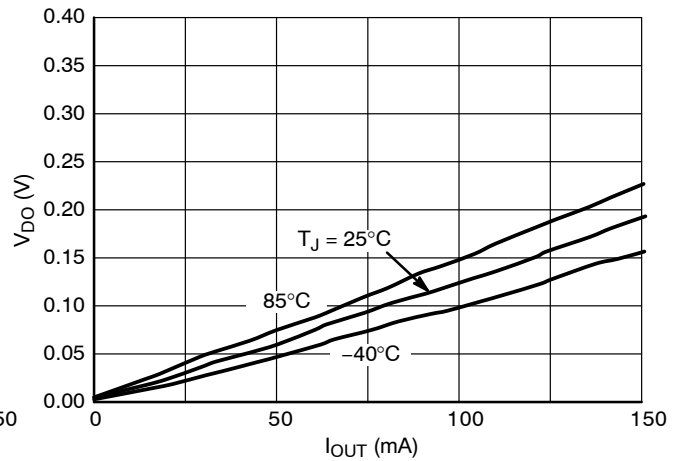

**Figure 7. Dropout Voltage vs. Output Current
5.0 V Version**

TYPICAL CHARACTERISTICS

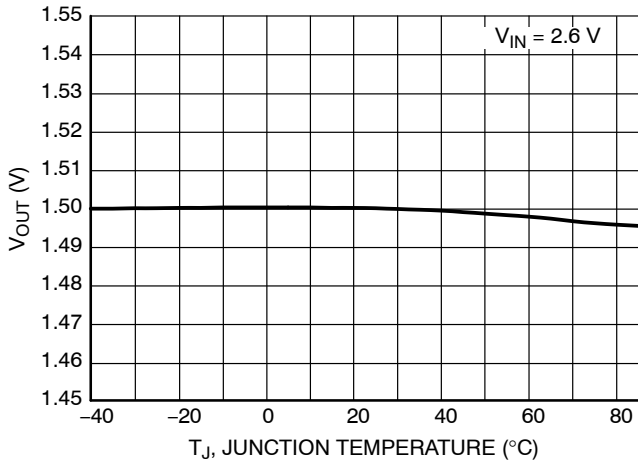

Figure 8. Output Voltage vs. Temperature, 1.5 V Version

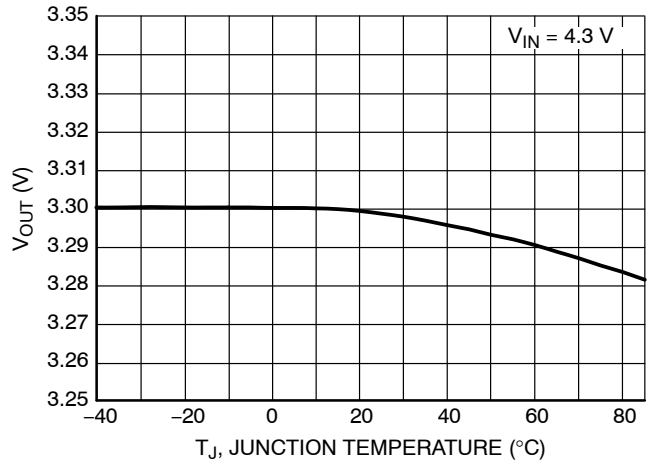

Figure 9. Output Voltage vs. Temperature, 3.3 V Version

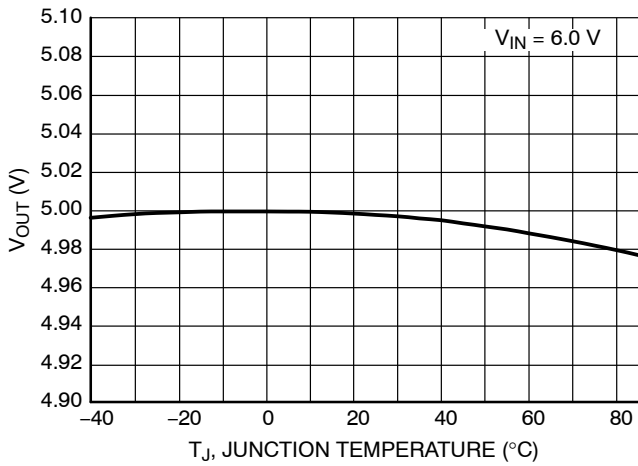

Figure 10. Output Voltage vs. Temperature, 5.0 V Version

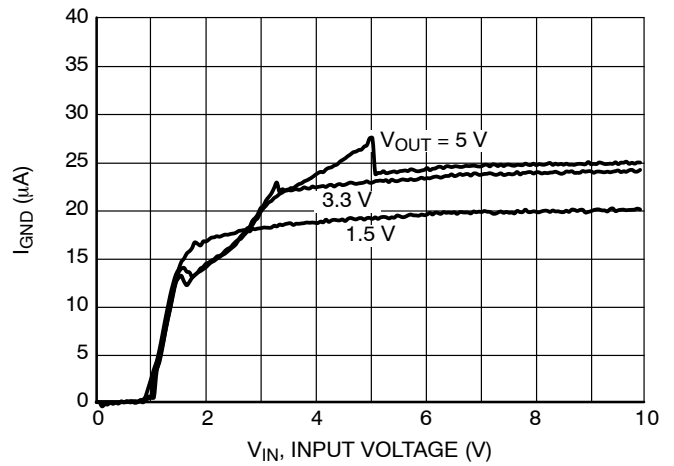

Figure 11. Supply Current vs. Input Voltage

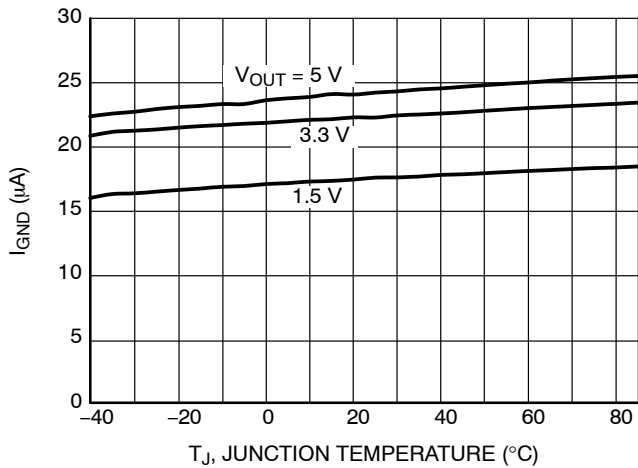

Figure 12. Supply Current vs. Temperature

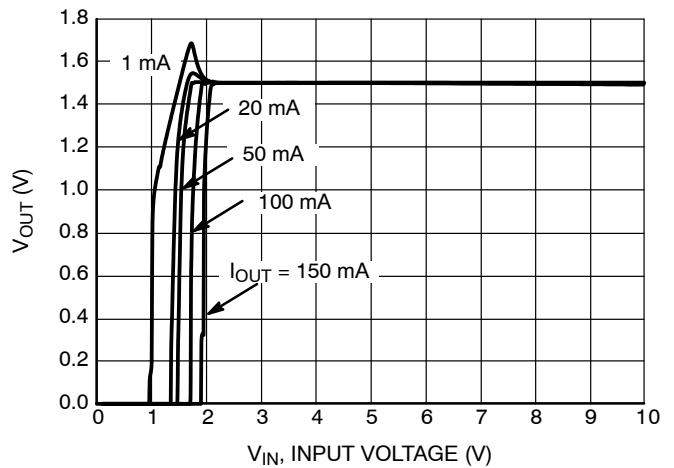

Figure 13. Output Voltage vs. Input Voltage, 1.5 V Version

TYPICAL CHARACTERISTICS

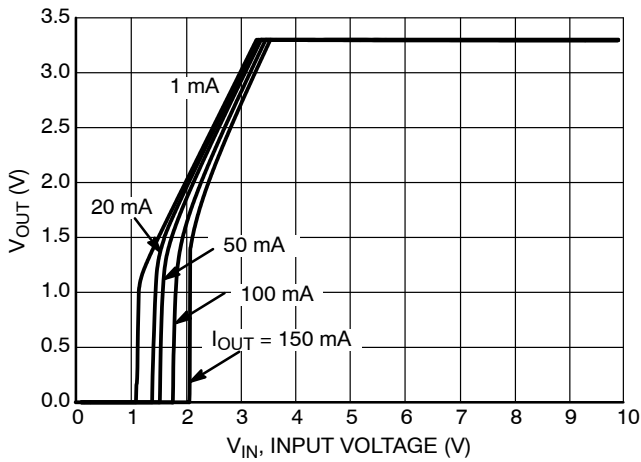

Figure 14. Output Voltage vs. Input Voltage, 3.3 V Version

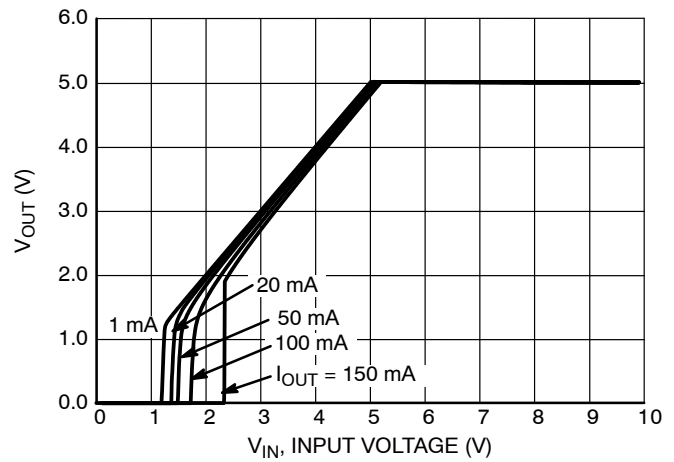

Figure 15. Output Voltage vs. Input Voltage, 5.0 V Version

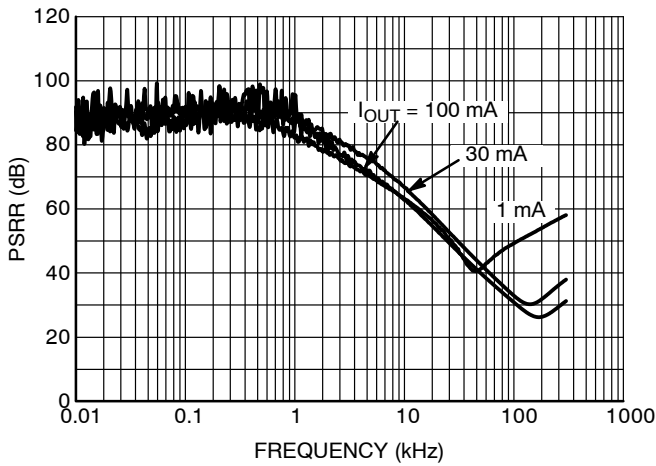

Figure 16. PSRR, 1.5 V Version, $V_{IN} = 3.5 V$

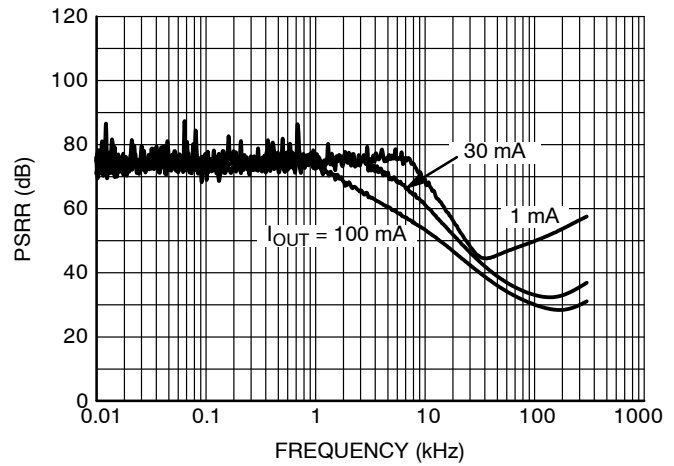

Figure 17. PSRR, 3.3 V Version, $V_{IN} = 5.3 V$

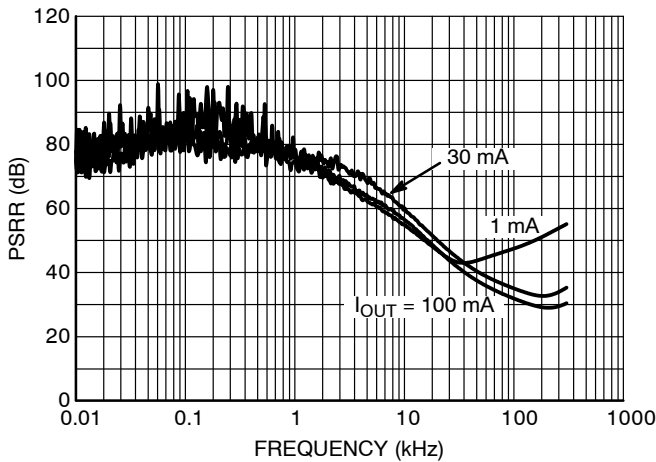

Figure 18. PSRR, 5.0 V Version, $V_{IN} = 7.0 V$

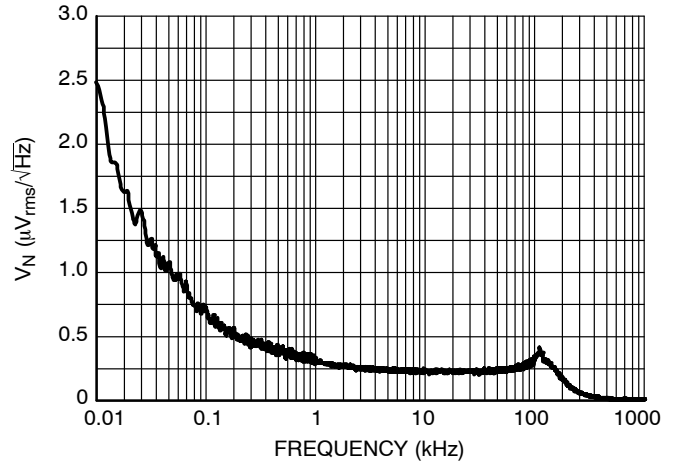

Figure 19. Output Voltage Noise, 1.5 V Version, $V_{IN} = 2.6 V$, $I_{OUT} = 30 mA$

NCP4620

TYPICAL CHARACTERISTICS

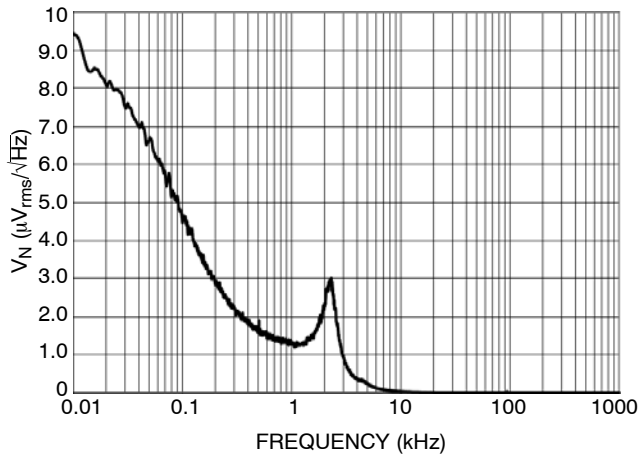

Figure 20. Output Voltage Noise, 3.3 V Version,
 $V_{IN} = 4.3 \text{ V}$, $I_{OUT} = 30 \text{ mA}$

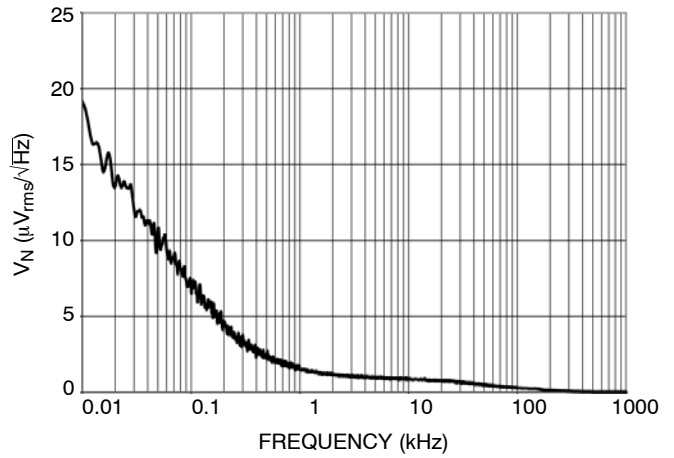

Figure 21. Output Voltage Noise, 5.0 V Version,
 $V_{IN} = 6.0 \text{ V}$, $I_{OUT} = 30 \text{ mA}$

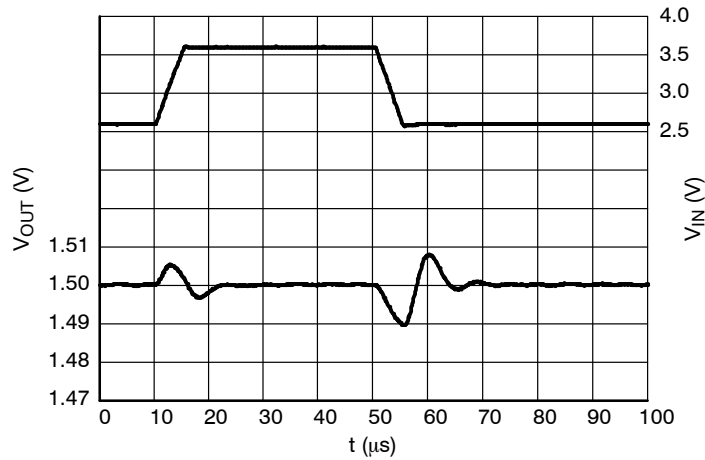

Figure 22. Line Transients, 1.5 V Version,
 $t_R = t_F = 5 \mu\text{s}$, $I_{OUT} = 30 \text{ mA}$

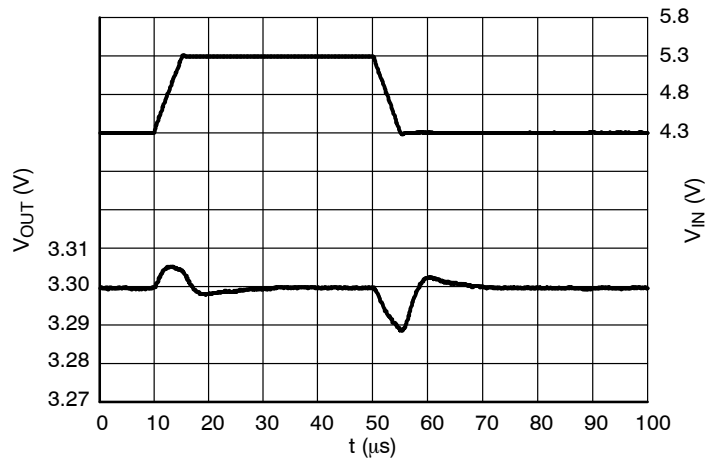

Figure 23. Line Transients, 3.3 V Version,
 $t_R = t_F = 5 \mu\text{s}$, $I_{OUT} = 30 \text{ mA}$

NCP4620

TYPICAL CHARACTERISTICS

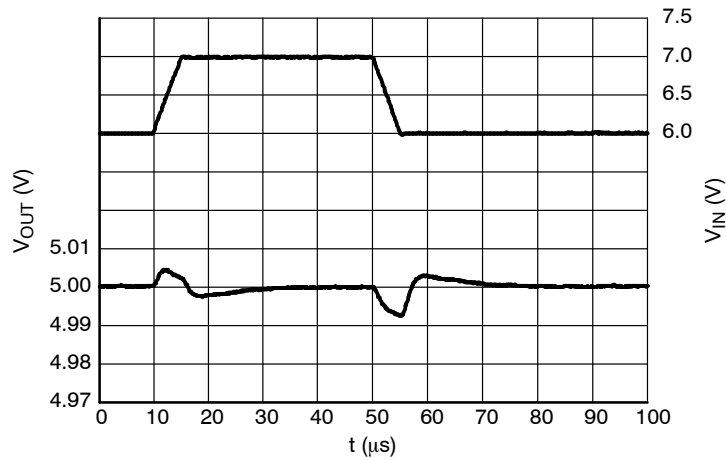

Figure 24. Line Transients, 5.0 V version,
 $t_R = t_F = 5 \mu$ s, $I_{OUT} = 30$ mA

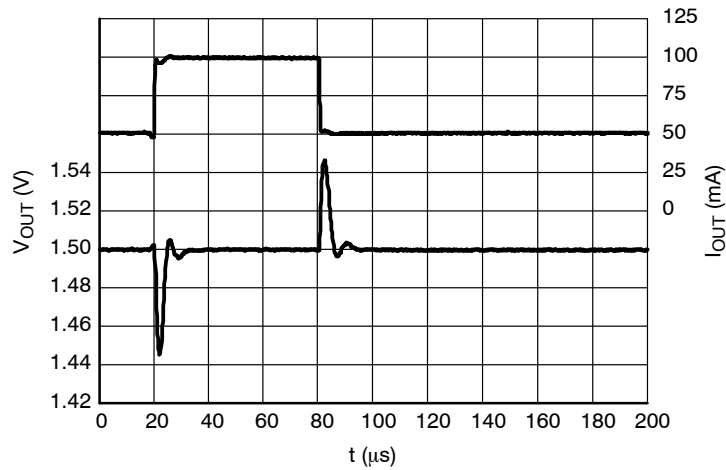

Figure 25. Load Transients, 1.5 V Version,
 $I_{OUT} = 50 - 100$ mA, $t_R = t_F = 0.5 \mu$ s, $V_{IN} = 2.6$ V

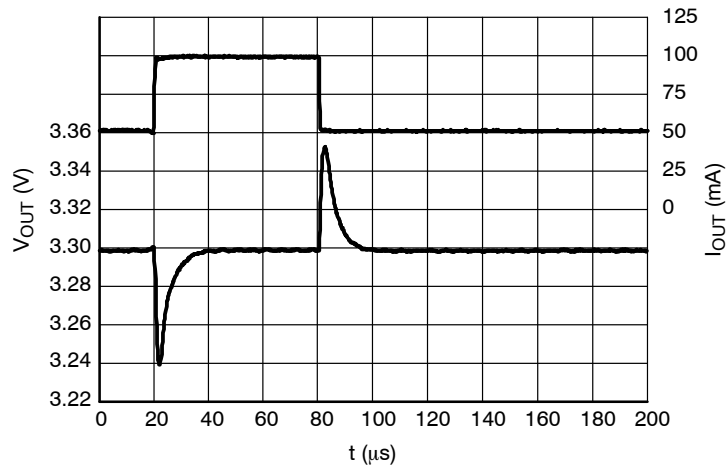
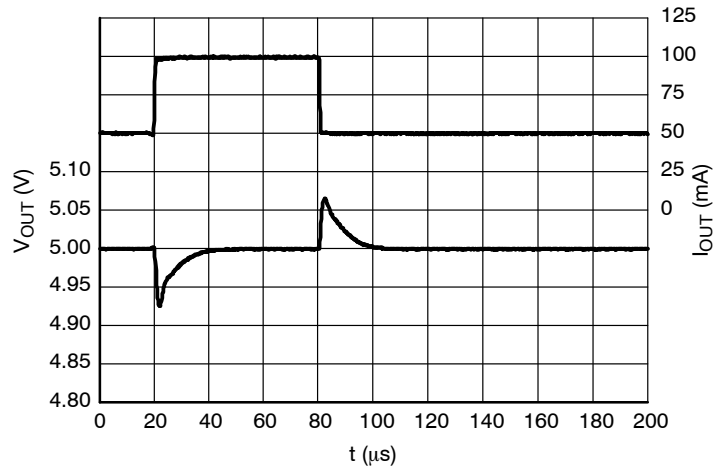

Figure 26. Load Transients, 3.3 V Version,
 $I_{OUT} = 50 - 100$ mA, $t_R = t_F = 0.5 \mu$ s, $V_{IN} = 4.3$ V

NCP4620

TYPICAL CHARACTERISTICS



**Figure 27. Load Transients, 5.0 V Version,
 $I_{OUT} = 50 - 100 \text{ mA}$, $t_R = t_F = 0.5 \mu\text{s}$, $V_{IN} = 6.0 \text{ V}$**

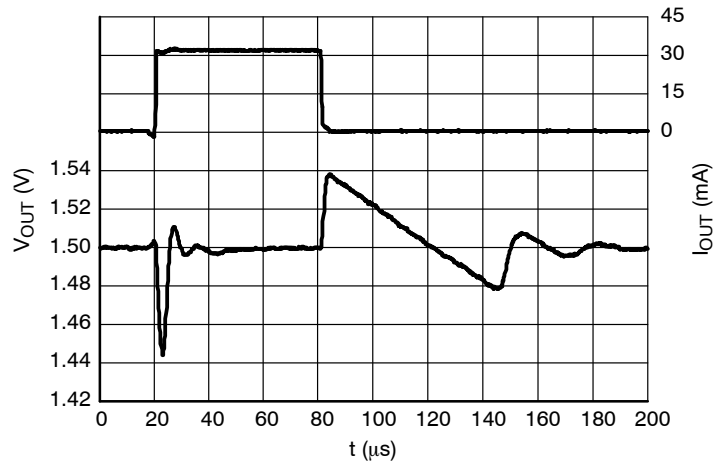

**Figure 28. Load Transients, 1.5 V Version,
 $I_{OUT} = 1 - 30 \text{ mA}$, $t_R = t_F = 0.5 \mu\text{s}$, $V_{IN} = 2.6 \text{ V}$**

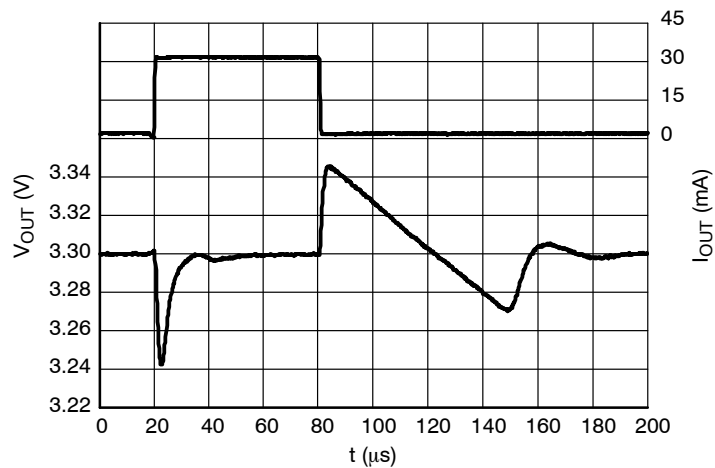

**Figure 29. Load Transients, 3.3 V Version,
 $I_{OUT} = 1 - 30 \text{ mA}$, $t_R = t_F = 0.5 \mu\text{s}$, $V_{IN} = 4.3 \text{ V}$**

NCP4620

TYPICAL CHARACTERISTICS

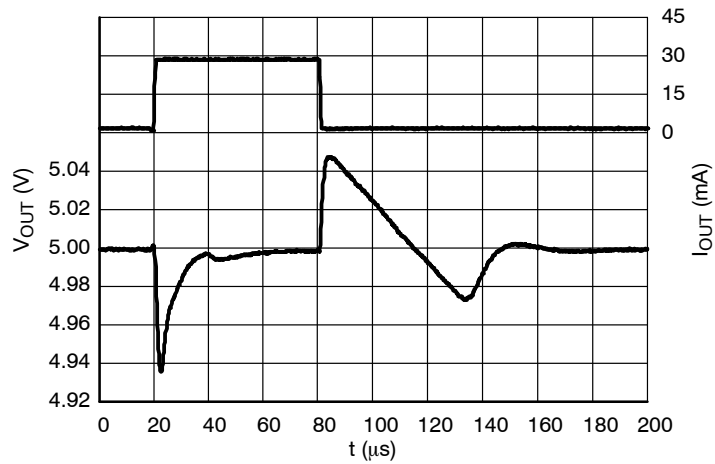

**Figure 30. Load Transients, 5.0 V Version,
 $I_{OUT} = 1 - 30 \text{ mA}$, $t_R = t_F = 0.5 \mu\text{s}$, $V_{IN} = 6.0 \text{ V}$**

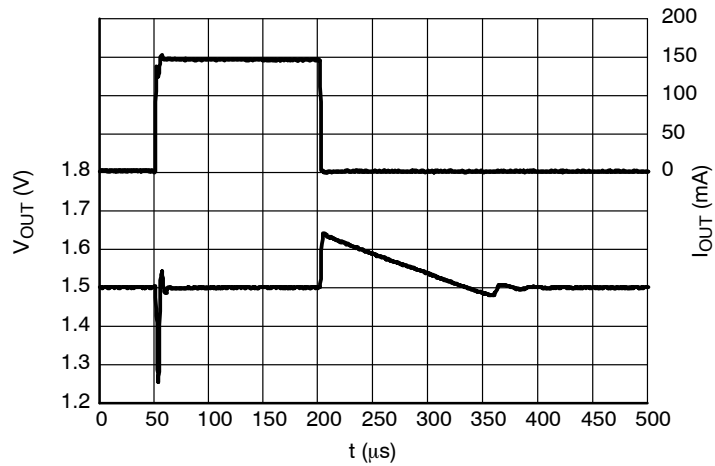

**Figure 31. Load Transients, 1.5 V Version,
 $I_{OUT} = 1 - 150 \text{ mA}$, $t_R = t_F = 0.5 \mu\text{s}$, $V_{IN} = 2.6 \text{ V}$**

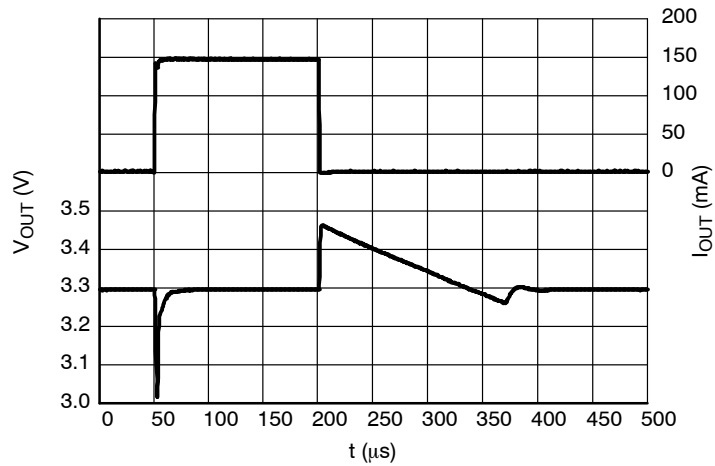

**Figure 32. Load Transients, 3.3 V Version,
 $I_{OUT} = 1 - 150 \text{ mA}$, $t_R = t_F = 0.5 \mu\text{s}$, $V_{IN} = 3.8 \text{ V}$**

NCP4620

TYPICAL CHARACTERISTICS

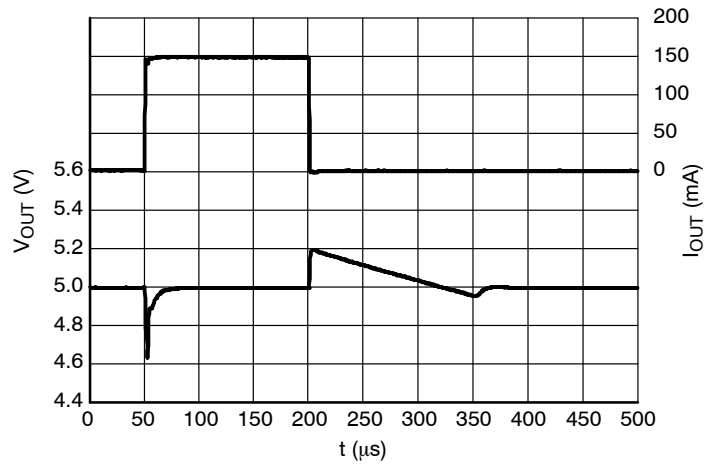

**Figure 33. Load Transients, 5.0 V Version,
I_{OUT} = 1 – 150 mA, t_R = t_F = 0.5 μs, V_{IN} = 6.0 V**

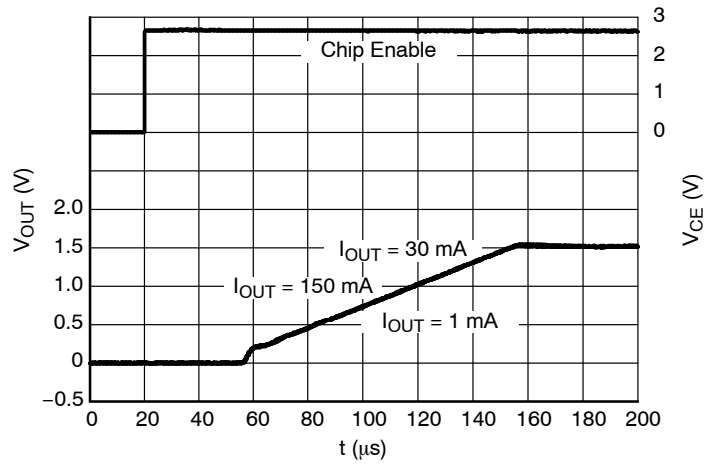

Figure 34. Start-up, 1.5 V Version, V_{IN} = 2.6 V

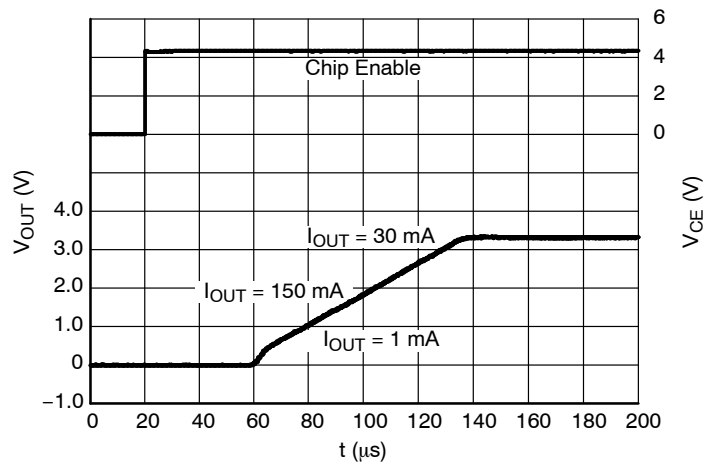

Figure 35. Start-up, 3.3 V Version, V_{IN} = 4.3 V

NCP4620

TYPICAL CHARACTERISTICS

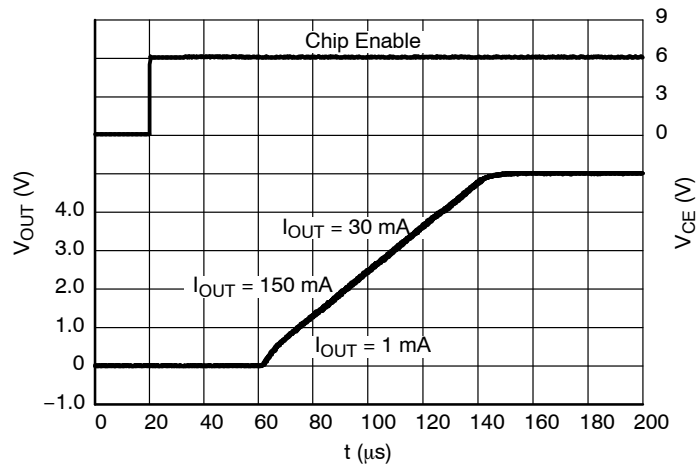

Figure 36. Start-up, 5.0 V Version, $V_{\text{IN}} = 6.0 \text{ V}$

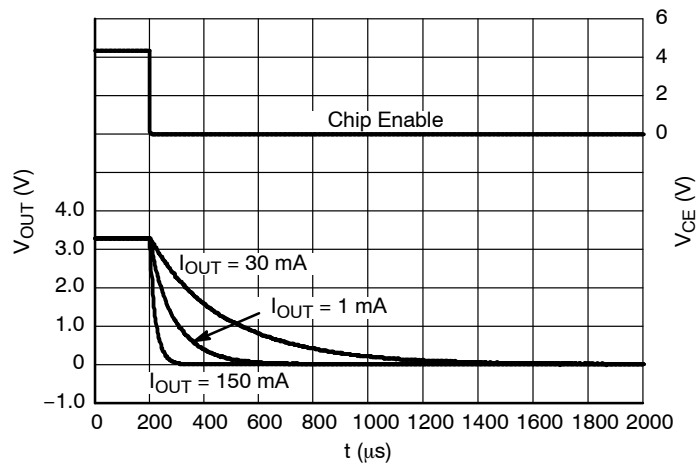

Figure 37. Shutdown, 3.3 V Version D,
 $V_{\text{IN}} = 4.3 \text{ V}$

APPLICATION INFORMATION

A typical application circuit for NCP4620 series is shown in Figure 38.

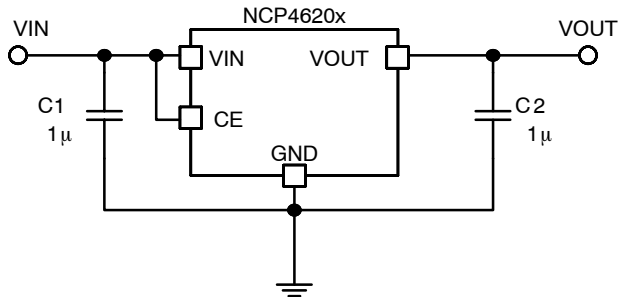

Figure 38. Typical Application Schematic

Input Decoupling Capacitor (C1)

A 1 μF ceramic input decoupling capacitor should be connected as close as possible to the input and ground pin of the NCP4620. Higher values and lower ESR improves line transient response.

Output Decoupling Capacitor (C2)

A 1 μF ceramic output decoupling capacitor is enough to achieve stable operation of the IC. If a tantalum capacitor is used, and its ESR is high, loop oscillation may result. The capacitors should be connected as close as possible to the output and ground pins. Larger values and lower ESR improves dynamic parameters.

Enable Operation

The enable pin CE may be used for turning the regulator on and off. The IC is switched on when a high level voltage is applied to the CE pin. The enable pin has an internal pull down current source. If the enable function is not needed connect CE pin to VIN.

Output Discharger

The D version includes a transistor between VOUT and GND that is used for faster discharging of the output capacitor. This function is activated when the IC goes into disable mode.

Thermal

As a power across the IC increase, it might become necessary to provide some thermal relief. The maximum power dissipation supported by the device is dependent upon board design and layout. Mounting pad configuration on the PCB, the board material, and also the ambient temperature affect the rate of temperature increase for the part. When the device has good thermal conductivity through the PCB the junction temperature will be relatively low in high power dissipation applications.

PCB layout

Make the VIN and GND line as large as practical. If their impedance is high, noise pickup or unstable operation may result. Connect capacitors C1 and C2 as close as possible to the IC, and make wiring as short as possible.

NCP4620

ORDERING INFORMATION

Device	Nominal Output Voltage	Description	Marking	Package	Shipping [†]
NCP4620DSN15T1G	1.5 V	Auto discharge	JBE	SOT-23 (Pb-Free)	3000 / Tape & Reel
NCP4620DSN30T1G	3.0 V	Auto discharge	JBX	SOT-23 (Pb-Free)	3000 / Tape & Reel
NCP4620DSN33T1G	3.3 V	Auto discharge	KBA	SOT-23 (Pb-Free)	3000 / Tape & Reel
NCP4620DSN50T1G	5.0 V	Auto discharge	KBT	SOT-23 (Pb-Free)	3000 / Tape & Reel
NCP4620HSN15T1G	1.5 V	Standard	JAE	SOT-23 (Pb-Free)	3000 / Tape & Reel
NCP4620HSN33T1G	3.3 V	Standard	KAA	SOT-23 (Pb-Free)	3000 / Tape & Reel
NCP4620HSN50T1G	5.0 V	Standard	KAT	SOT-23 (Pb-Free)	3000 / Tape & Reel
NCP4620DSQ18T1G	1.8 V	Auto discharge	AD08	SC-70 (Pb-Free)	3000 / Tape & Reel
NCP4620HSQ12T1G	1.2 V	Standard	AC01	SC-70 (Pb-Free)	3000 / Tape & Reel
NCP4620HSQ15T1G	1.5 V	Standard	AC05	SC-70 (Pb-Free)	3000 / Tape & Reel
NCP4620HSQ18T1G	1.8 V	Standard	AC08	SC-70 (Pb-Free)	3000 / Tape & Reel
NCP4620HSQ25T1G	2.5 V	Standard	AC16	SC-70 (Pb-Free)	3000 / Tape & Reel

†For information on tape and reel specifications, including part orientation and tape sizes, please refer to our Tape and Reel Packaging Specifications Brochure, BRD8011/D.

*To order other package and voltage variants, please contact your ON Semiconductor sales representative.

MECHANICAL CASE OUTLINE

PACKAGE DIMENSIONS

ON Semiconductor®



SCALE 2:1

SOT-23 5-LEAD CASE 1212-01 ISSUE A

DATE 28 JAN 2011

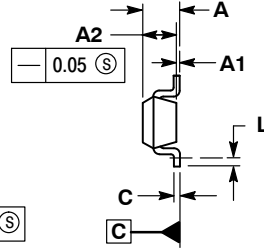
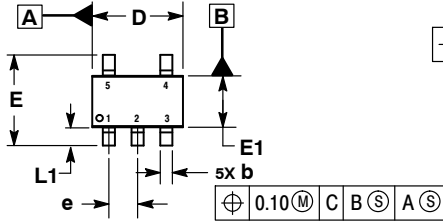

NOTES:

1. DIMENSIONING AND TOLERANCING PER ASME Y14.5M, 1994.
2. CONTROLLING DIMENSIONS: MILLIMETERS.
3. DATUM C IS THE SEATING PLANE.

MILLIMETERS		
DIM	MIN	MAX
A	---	1.45
A1	0.00	0.10
A2	1.00	1.30
b	0.30	0.50
c	0.10	0.25
D	2.70	3.10
E	2.50	3.10
E1	1.50	1.80
e	0.95 BSC	---
L	0.20	---
L1	0.45	0.75

RECOMMENDED SOLDERING FOOTPRINT*

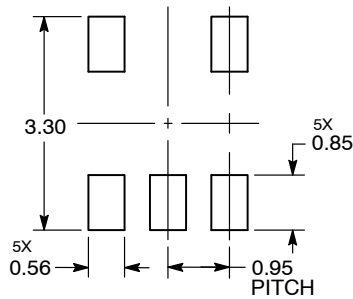

DIMENSIONS: MILLIMETERS

*For additional information on our Pb-Free strategy and soldering details, please download the ON Semiconductor Soldering and Mounting Techniques Reference Manual, SOLDERRM/D.

GENERIC MARKING DIAGRAM*

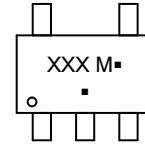

XXX = Specific Device Code

M = Date Code

▪ = Pb-Free Package

(Note: Microdot may be in either location)

*This information is generic. Please refer to device data sheet for actual part marking. Pb-Free indicator, "G" or microdot "▪", may or may not be present.

DOCUMENT NUMBER:	98ASH70518A	Electronic versions are uncontrolled except when accessed directly from the Document Repository. Printed versions are uncontrolled except when stamped "CONTROLLED COPY" in red.
DESCRIPTION:	SOT-23 5-LEAD	PAGE 1 OF 1

ON Semiconductor and are trademarks of Semiconductor Components Industries, LLC dba ON Semiconductor or its subsidiaries in the United States and/or other countries. ON Semiconductor reserves the right to make changes without further notice to any products herein. ON Semiconductor makes no warranty, representation or guarantee regarding the suitability of its products for any particular purpose, nor does ON Semiconductor assume any liability arising out of the application or use of any product or circuit, and specifically disclaims any and all liability, including without limitation special, consequential or incidental damages. ON Semiconductor does not convey any license under its patent rights nor the rights of others.

MECHANICAL CASE OUTLINE PACKAGE DIMENSIONS



SCALE 2:1

SC-88A (SC-70-5/SOT-353) CASE 419A-02 ISSUE M

DATE 11 APR 2023



RECOMMENDED MOUNTING FOOTPRINT

* For additional information on our Pb-Free strategy and soldering details, please download the ON Semiconductor Soldering and Mounting Techniques Reference Manual, SOLDERM/D.

NOTES:

1. DIMENSIONING AND TOLERANCING PER ANSI Y14.5M, 1982.
2. CONTROLLING DIMENSION: MILLIMETERS
3. 419A-01 OBSOLETE. NEW STANDARD 419A-02
4. DIMENSIONS D AND E1 DO NOT INCLUDE MOLD FLASH, PROTRUSIONS, OR GATE BURRS. MOLD FLASH, PROTRUSIONS, OR GATE BURRS SHALL NOT EXCEED 0.1016MM PER SIDE.

DIM	MILLIMETERS		
	MIN.	NOM.	MAX.
A	0.80	0.95	1.10
A1	---	---	0.10
A3	0.20 REF		
b	0.10	0.20	0.30
c	0.10	---	0.25
D	1.80	2.00	2.20
E	2.00	2.10	2.20
E1	1.15	1.25	1.35
e	0.65 BSC		
L	0.10	0.15	0.30

GENERIC MARKING DIAGRAM*



*This information is generic. Please refer to device data sheet for actual part marking. Pb-Free indicator, "G" or microdot "▪", may or may not be present. Some products may not follow the Generic Marking.

XXX = Specific Device Code

M = Date Code

▪ = Pb-Free Package

(Note: Microdot may be in either location)

STYLE 1:

1. BASE
2. EMITTER
3. BASE
4. COLLECTOR
5. COLLECTOR

STYLE 2:

1. ANODE
2. EMITTER
3. BASE
4. COLLECTOR
5. CATHODE

STYLE 3:

1. ANODE 1
2. N/C
3. ANODE 2
4. CATHODE 2
5. CATHODE 1

STYLE 4:

1. SOURCE 1
2. DRAIN 1/2
3. SOURCE 1
4. GATE 1
5. GATE 2

STYLE 5:

1. CATHODE
2. COMMON ANODE
3. CATHODE 2
4. CATHODE 3
5. CATHODE 4

STYLE 6:

1. EMITTER 2
2. BASE 2
3. EMITTER 1
4. COLLECTOR
5. COLLECTOR 2/BASE 1

STYLE 7:

1. BASE
2. EMITTER
3. BASE
4. COLLECTOR
5. COLLECTOR

STYLE 8:

1. CATHODE
2. COLLECTOR
3. N/C
4. BASE
5. EMITTER

STYLE 9:

1. ANODE
2. CATHODE
3. ANODE
4. ANODE
5. ANODE

Note: Please refer to datasheet for style callout. If style type is not called out in the datasheet refer to the device datasheet pinout or pin assignment.

DOCUMENT NUMBER:	98ASB42984B	Electronic versions are uncontrolled except when accessed directly from the Document Repository. Printed versions are uncontrolled except when stamped "CONTROLLED COPY" in red.
DESCRIPTION:	SC-88A (SC-70-5/SOT-353)	PAGE 1 OF 1

onsemi and ONSEMI are trademarks of Semiconductor Components Industries, LLC dba onsemi or its subsidiaries in the United States and/or other countries. onsemi reserves the right to make changes without further notice to any products herein. onsemi makes no warranty, representation or guarantee regarding the suitability of its products for any particular purpose, nor does onsemi assume any liability arising out of the application or use of any product or circuit, and specifically disclaims any and all liability, including without limitation special, consequential or incidental damages. onsemi does not convey any license under its patent rights nor the rights of others.

onsemi, **Onsemi**, and other names, marks, and brands are registered and/or common law trademarks of Semiconductor Components Industries, LLC dba "**onsemi**" or its affiliates and/or subsidiaries in the United States and/or other countries. **onsemi** owns the rights to a number of patents, trademarks, copyrights, trade secrets, and other intellectual property. A listing of **onsemi**'s product/patent coverage may be accessed at www.onsemi.com/site/pdf/Patent-Marking.pdf. **onsemi** reserves the right to make changes at any time to any products or information herein, without notice. The information herein is provided "as-is" and **onsemi** makes no warranty, representation or guarantee regarding the accuracy of the information, product features, availability, functionality, or suitability of its products for any particular purpose, nor does **onsemi** assume any liability arising out of the application or use of any product or circuit, and specifically disclaims any and all liability, including without limitation special, consequential or incidental damages. Buyer is responsible for its products and applications using **onsemi** products, including compliance with all laws, regulations and safety requirements or standards, regardless of any support or applications information provided by **onsemi**. "Typical" parameters which may be provided in **onsemi** data sheets and/or specifications can and do vary in different applications and actual performance may vary over time. All operating parameters, including "Typicals" must be validated for each customer application by customer's technical experts. **onsemi** does not convey any license under any of its intellectual property rights nor the rights of others. **onsemi** products are not designed, intended, or authorized for use as a critical component in life support systems or any FDA Class 3 medical devices or medical devices with a same or similar classification in a foreign jurisdiction or any devices intended for implantation in the human body. Should Buyer purchase or use **onsemi** products for any such unintended or unauthorized application, Buyer shall indemnify and hold **onsemi** and its officers, employees, subsidiaries, affiliates, and distributors harmless against all claims, costs, damages, and expenses, and reasonable attorney fees arising out of, directly or indirectly, any claim of personal injury or death associated with such unintended or unauthorized use, even if such claim alleges that **onsemi** was negligent regarding the design or manufacture of the part. **onsemi** is an Equal Opportunity/Affirmative Action Employer. This literature is subject to all applicable copyright laws and is not for resale in any manner.

ADDITIONAL INFORMATION

TECHNICAL PUBLICATIONS:

Technical Library: www.onsemi.com/design/resources/technical-documentation
onsemi Website: www.onsemi.com

ONLINE SUPPORT: www.onsemi.com/support

For additional information, please contact your local Sales Representative at www.onsemi.com/support/sales

