

ecoSwitch™

Advanced Load Management

Controlled Load Switch with Reverse Current Protection and Ultra Low R_{ON}

NCP45790

The NCP45790 load management device provides a component and area-reducing solution for efficient power domain switching with inrush current limit via soft start. This device is designed to integrate control and driver functionality with back-to-back high performance low on-resistance power MOSFETs in a single package. This cost effective solution is ideal for reverse current applications and the specific power management and disconnect functions used in USB Type-C and Type-C Power Delivery ports.

Features

- Advanced Controller with Charge Pump
- Integrated N-Channel MOSFET with Ultra Low R_{ON}
- Soft-Start via Controlled Slew Rate
- Adjustable Slew Rate Control
- Fault Detection with Power Good Output
- Thermal Shutdown and Under Voltage Lockout
- Short-Circuit and Adjustable Over-Current Protections
- Reverse-Current Protection Option
- Input Voltage Range 3 V to 24 V
- Extremely Low Standby Current
- This is a Pb-free, RoHS/REACH Compliant Device

Typical Applications

- USB Type C & Type-C Power Delivery
- Reverse Current Load Switching Applications
- Servers, Set-Top Boxes and Gateways
- Notebook and Tablet Computers
- Telecom, Networking, Medical and Industrial Equipment
- Hot-Swap Devices and Peripheral Ports

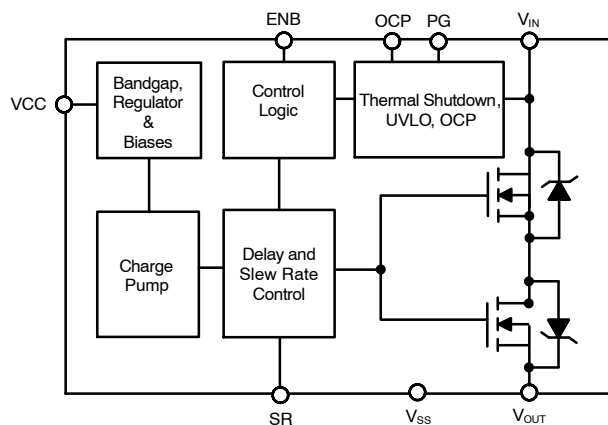

Figure 1. Block Diagram



ON Semiconductor®

www.onsemi.com

R_{ON} TYP	I_{MAX}^*
8.0 m Ω	8 A

* I_{MAX} is defined as the maximum steady state current the load switch can pass at room ambient temperature without entering thermal lockout. See the SOA section for more information on transient current limitations.

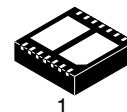

DFN14, 4x4
CASE 506EK

MARKING DIAGRAM

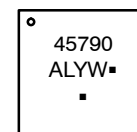

45790 = Specific Device Code
A = Assembly Location
L = Wafer Lot
Y = Year
W = Work Week
▪ = Pb-Free Package

(Note: Microdot may be in either location)

PIN CONFIGURATION

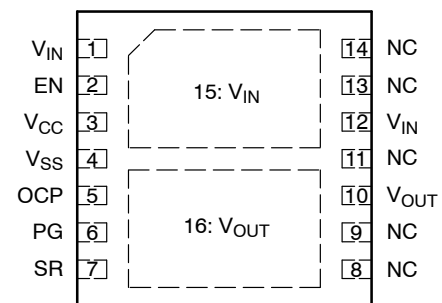

(Top View)

ORDERING INFORMATION

Device	Package	Shipping
NCP45790IMN24RTWG	DFN14 (Pb-Free)	3000 / Tape & Reel

†For information on tape and reel specifications, including part orientation and tape sizes, please refer to our Tape and Reel Packaging Specifications Brochure, BRD8011/D.

NCP45790

Table 1. PIN DESCRIPTION

Pin	Name	Function
1,12,15	V _{IN}	Input voltage (3 V – 24 V) – Pin 15 should be used for high current (>0.5 A)
2	EN	Active–high digital input used to turn on the MOSFET driver, pin has an internal pull down resistor to GND
3	V _{CC}	Driver supply voltage (3.0 V – 5.5 V)
4	V _{SS}	Driver ground
5	OCP	Over–current protection trip point adjustment made with a voltage applied (0 V – 1.2 V), pin has an internal pull up resistor to EN; short to ground if over–current protection is not needed
6	PG	Active–high, open–drain output that indicates when the gate of the MOSFET is fully charged, external pull up resistor ≥ 100 kΩ to an external voltage source required; tie to GND if not used.
7	SR	Slew Rate control pin. Slew rate adjustment made with an external capacitor to GND; float if not used.
10,16	V _{OUT}	Source of MOSFET connected to load. Includes an internal bleed resistor to GND. – Pin 16 should be used for high current (>0.5 A)

Table 2. ABSOLUTE MAXIMUM RATINGS

Rating	Symbol	Value	Unit
Supply Voltage Range	V _{CC}	–0.3 to 6	V
Input Voltage Range	V _{IN}	–0.3 to 30	V
Output Voltage Range	V _{OUT}	–0.3 to 30	V
EN Input Voltage Range	V _{EN}	GND–0.3 to (V _{CC} + 0.3)	V
PG Output Voltage Range (Note 1)	V _{PG}	–0.3 to 6	V
OCP Input Voltage Range	V _{OCP}	–0.3 to 6	V
Thermal Resistance, Junction–to–Ambient, Steady State (Note 2)	R _{θJA}	28.6	°C/W
Thermal Resistance, Junction–to–Case (V _{IN} Paddle)	R _{θJC}	1.7	°C/W
Continuous MOSFET Current @ T _A = 25°C (Note 2)	I _{MAX}	20	A
Total Power Dissipation @ T _A = 25°C (Note 2) Derate above T _A = 25°C	P _D	3.49 34.9	W mW/°C
Storage Temperature Range	T _{STG}	–55 to 150	°C
Lead Temperature, Soldering (10 sec.)	T _{SLD}	260	°C
ESD Capability, Human Body Model (Notes 3 and 4)	ESD _{HBM}	2	kV
ESD Capability, Charged Device Model (Notes 3 and 4)	ESD _{CDM}	1	kV
Latch–up Current Immunity (Note 3)	LU	100	mA

Stresses exceeding those listed in the Maximum Ratings table may damage the device. If any of these limits are exceeded, device functionality should not be assumed, damage may occur and reliability may be affected.

1. PG is an open drain output that requires an external pull–up resistor > 100 kΩ to an external voltage source.
2. Surface–mounted on FR4 board using the minimum recommended pad size, 1 oz Cu. Over current protection will limit maximum realized current to 8 A at highest setting.
3. Tested by the following methods @ T_A = 25°C:
 ESD Human Body Model tested per JESD22–A114
 ESD Charged Device Model per ESD STM5.3.1
 Latch–up Current tested per JESD78
4. Rating is for all pins except for V_{IN} and V_{OUT} which are tied to the internal MOSFET’s Drain and Source. Typical MOSFET ESD performance for V_{IN} and V_{OUT} should be expected and these devices should be treated as ESD sensitive.

NCP45790

Table 3. OPERATING RANGES

Rating	Symbol	Min	Max	Unit
VCC – (VIN > 4.5 V)	VCC	3	5.5	V
VCC – (VIN < 4.5 V)	VCC	4.5	5.5	V
VIN – (VCC > 4.5 V)	VIN	3	24	V
VIN – (VCC < 4.5 V)	VIN	4.5	24	V
OCP External Resistor to VSS	ROCP	short	open	kΩ
OFF to ON Transition Energy Dissipation Limit (See Application Section)	ETTRANS	0	200	mJ
VSS	VSS	–	0	V
Ambient Temperature	TA	–40	85	°C
Junction Temperature	TJ	–40	125	°C

Functional operation above the stresses listed in the Recommended Operating Ranges is not implied. Extended exposure to stresses beyond the Recommended Operating Ranges limits may affect device reliability.

Table 4. ELECTRICAL CHARACTERISTICS (TJ = 25°C, VCC = 3 V – 5.5 V, unless otherwise specified)

Parameter	Conditions	Symbol	Min	Typ	Max	Unit
On-Resistance	VCC = 4.5 V; VIN = 3 V	RON	–	8.0	9.0	mΩ
	VCC = 3.3 V; VIN = 4.5 V		–	8.0	9.0	
	VCC = 3.3 V; VIN = 15 V		–	8.0	9.0	
	VCC = 3.3 V; VIN = 24 V		–	8.0	9.0	
Leakage Current – VIN to VOUT (Note 5)	VEN = 0 V; VIN = 24 V	I _{LEAK}	–	10.8	100	nA
Reverse Leakage – VOUT to VIN	VEN = 0 V; VIN = 24 V (for typical)	I _{RLEAK}	–	35	100	nA
VIN Control Current – VIN to VSS	VEN = 0 V; VIN = 24 V (for typical)	I _{INCTL}	–	0.8	1.5	μA
	VEN = VCC; VIN = 24 V (for typical)	I _{INCTL}	–	150	300	μA
Supply Standby Current (Note 6)	VEN = 0 V; VIN = 24 V (for typical)	I _{STBY}	–	1.3	5	μA
Supply Dynamic Current (Note 7)	VEN = VCC; VIN = 24 V (for typical)	I _{DYN}	–	0.3	0.5	mA
EN Input High Voltage		V _{IH}	2	–	–	V
EN Input Low Voltage		V _{IL}	–	–	0.8	V
EN Input Leakage Current	VEN = 0 V	I _{IL}	–1.0	–	1	μA
EN Pull Down Resistance		R _{PD}	76	100	124	kΩ
PG Output Low Voltage	I _{SINK} = 100 μA	V _{OL}	–	21.8	100	mV
PG Output Leakage Current	V _{TERM} = 3.3 V	I _{OH}	–	3.45	100	nA
Slew Rate Control Constant (Note 8)		K _{SR}	70	99	130	μA

FAULT PROTECTIONS

Thermal Shutdown Threshold (Note 9)		T _{SDT}	–	145	–	°C
Thermal Shutdown Hysteresis (Note 9)		T _{HYS}	–	20	–	°C
VIN Under Voltage Lockout Threshold	VIN rising	V _{UVLO}	–	2.0	2.1	V
VIN Under Voltage Lockout Hysteresis		V _{HYS}	–	220	300	mV
Over-Current Protection Trip	ROCP = open	ITRIP	0.6	1.0	1.2	A
	ROCP = 20 kΩ		–	7.1	–	
	ROCP = short to GND (Note 10)		–	11	–	
Over-Current Protection Blanking Time		t _{OCP}	–	2.25	–	ms
Short-Circuit Protection Trip Current (Note 11)	Soft Short & Hard Shorts (Note 12)	I _{SC}	–	11	–	A

Product parametric performance is indicated in the Electrical Characteristics for the listed test conditions, unless otherwise noted. Product performance may not be indicated by the Electrical Characteristics if operated under different conditions.

5. Average current from VIN to VOUT with MOSFET turned off.

6. Average current from VCC to GND with MOSFET turned off.

7. Average current from VCC to GND after charge up time of MOSFET.

8. See Applications Information section for details on how to adjust the gate slew rate.

9. Operation above TJ = 125°C is not guaranteed.

10. Transient currents exceeding the short-circuit protection trip current will cause the device to fault. For OCP settings less than 20 kΩ, high steady state currents may cause an over temperature lockout before the OCP threshold is reached due to self-heating.

11. Short circuit protection testing assumed a 100 W supply capability limit on Vin.

12. Short Circuit Protection protects the device against hard shorts (R_{SHORT} ≤ 250 mΩ Vout to Ground) for Vin < 18 V, and against soft shorts (R_{SHORT} > 250 mΩ) for Vin < 24 V.

NCP45790

Table 5. SWITCHING CHARACTERISTICS ($T_J = 25^\circ\text{C}$ unless otherwise specified) (Notes 13 and 14)

Parameter	Conditions	Symbol	Min	Typ	Max	Unit
Output Slew Rate – Default	$V_{CC} = 4.5\text{ V}; V_{IN} = 3\text{ V}$	SR	13	19.4	28	V/ms
	$V_{CC} = 5.0\text{ V}; V_{IN} = 3\text{ V}$		13	19.7	28	
	$V_{CC} = 3.3\text{ V}; V_{IN} = 24\text{ V}$		13	22.4	28	
	$V_{CC} = 5.0\text{ V}; V_{IN} = 24\text{ V}$		13	22.5	28	
Output Turn-on Delay	$V_{CC} = 4.5\text{ V}; V_{IN} = 3\text{ V}$	T_{ON}	100	188	700	μs
	$V_{CC} = 5.0\text{ V}; V_{IN} = 3\text{ V}$		100	187	700	
	$V_{CC} = 3.3\text{ V}; V_{IN} = 24\text{ V}$		100	846	700	
	$V_{CC} = 5.0\text{ V}; V_{IN} = 24\text{ V}$		100	480	700	
Output Turn-off Delay	$V_{CC} = 4.5\text{ V}; V_{IN} = 3\text{ V}$	T_{OFF}	–	105	–	μs
	$V_{CC} = 5.0\text{ V}; V_{IN} = 3\text{ V}$		–	96	–	
	$V_{CC} = 3.3\text{ V}; V_{IN} = 24\text{ V}$		–	90	–	
	$V_{CC} = 5.0\text{ V}; V_{IN} = 24\text{ V}$		–	78	–	
Power Good Turn-on Time	$V_{CC} = 4.5\text{ V}; V_{IN} = 3\text{ V}$	$T_{PG,ON}$	0.4	0.88	3.5	ms
	$V_{CC} = 5.0\text{ V}; V_{IN} = 3\text{ V}$		0.4	0.79	3.5	
	$V_{CC} = 3.3\text{ V}; V_{IN} = 24\text{ V}$		0.4	2.4	3.5	
	$V_{CC} = 5.0\text{ V}; V_{IN} = 24\text{ V}$		0.4	1.9	3.5	
Power Good Turn-off Time	$V_{CC} = 4.5\text{ V}; V_{IN} = 3\text{ V}$	$T_{PG,OFF}$	–	–	10	ns
	$V_{CC} = 5.0\text{ V}; V_{IN} = 3\text{ V}$		–	–	10	
	$V_{CC} = 3.3\text{ V}; V_{IN} = 24\text{ V}$		–	–	10	
	$V_{CC} = 5.0\text{ V}; V_{IN} = 24\text{ V}$		–	–	10	

13. See below figure for Test Circuit and Timing Diagram.

14. Tested with the following conditions: $V_{TERM} = V_{CC}$; $R_{PG} = 100\text{ k}\Omega$; $R_L = 10\ \Omega$; $C_L = 0.1\ \mu\text{F}$.

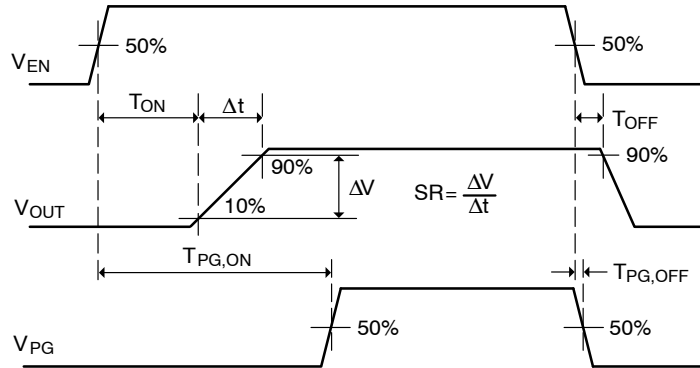
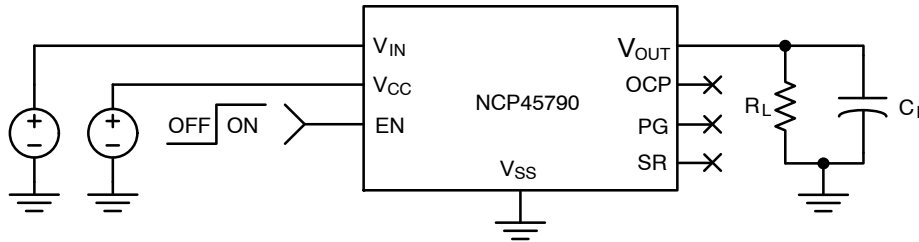

Figure 2. Switching Characteristics Test Circuit and Timing Diagrams

NCP45790

TYPICAL CHARACTERISTICS ($T_J = 25^\circ\text{C}$ unless otherwise specified)

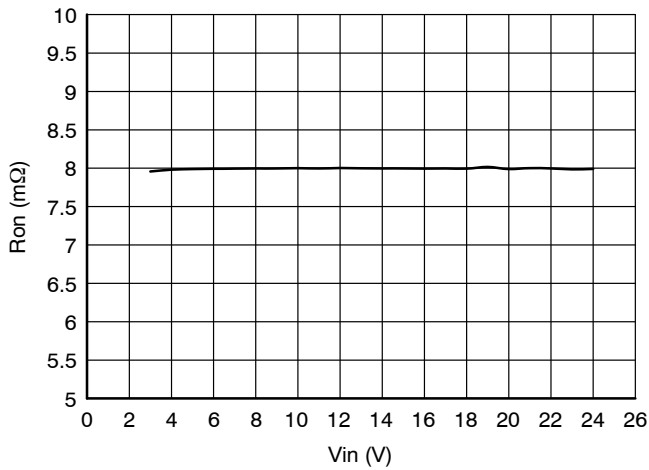

Figure 3. On-Resistance vs. Input Voltage

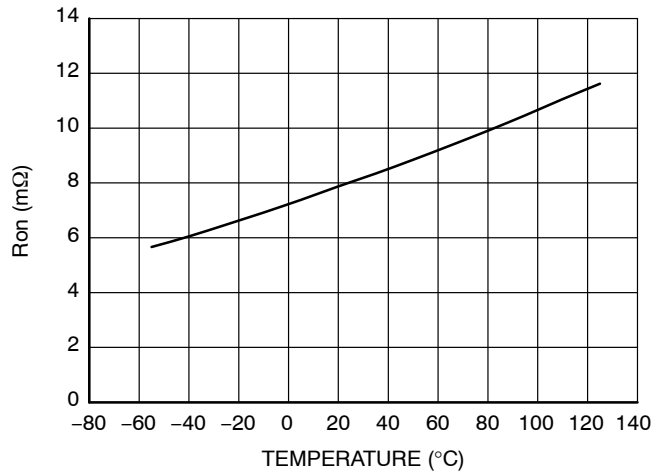

Figure 4. On-Resistance vs. Temperature

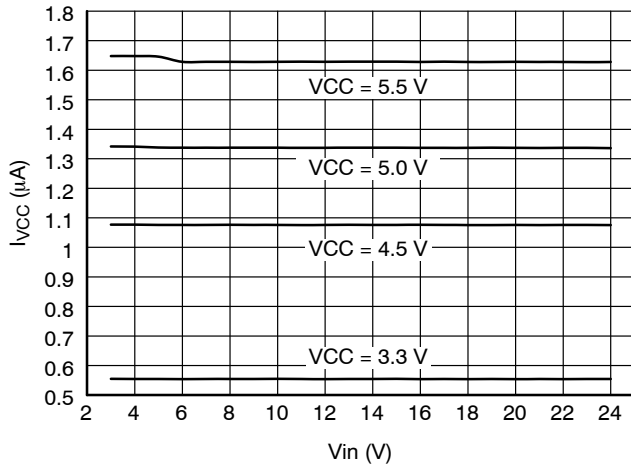

Figure 5. Supply Standby Current vs. Supply Voltage

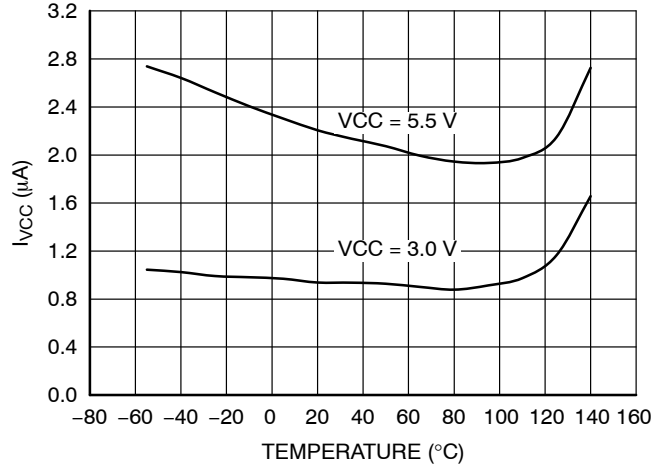

Figure 6. Supply Standby Current vs. Temperature

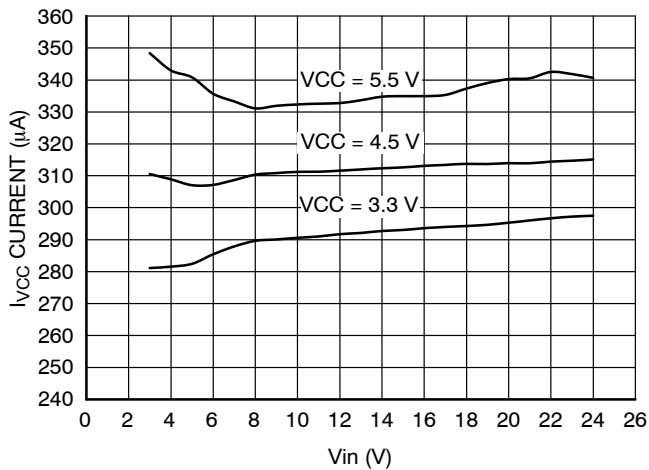

Figure 7. Dynamic Current vs. Input Voltage

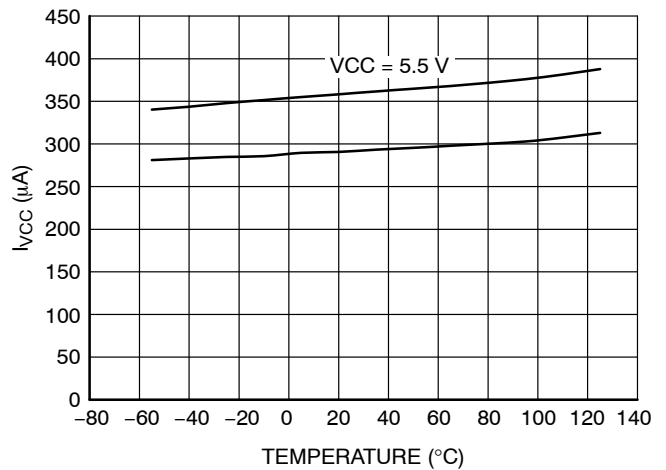

Figure 8. Supply Dynamic Current vs. Temperature

TYPICAL CHARACTERISTICS ($T_J = 25^\circ\text{C}$ unless otherwise specified) (continued)

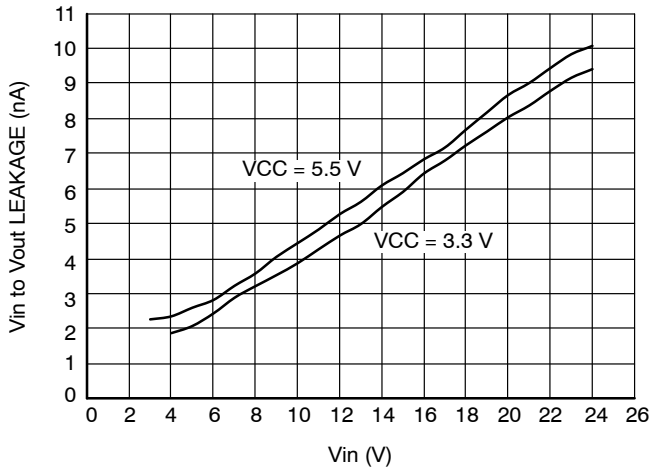

Figure 9. Input to Output Leakage vs. Input Voltage (EN = 0 V)

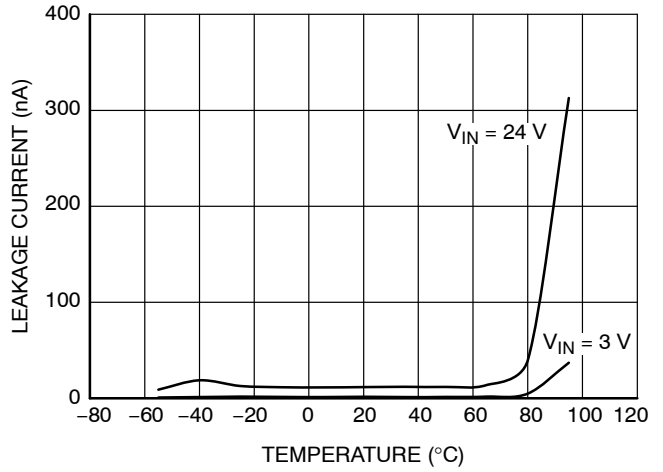

Figure 10. Input to Output Leakage vs. Temperature (EN = HIGH)

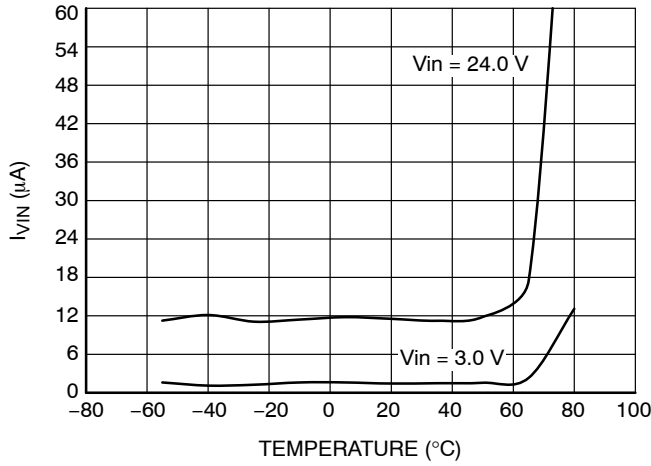

Figure 11. Vin Controller Current vs. Temperature (EN = 0)

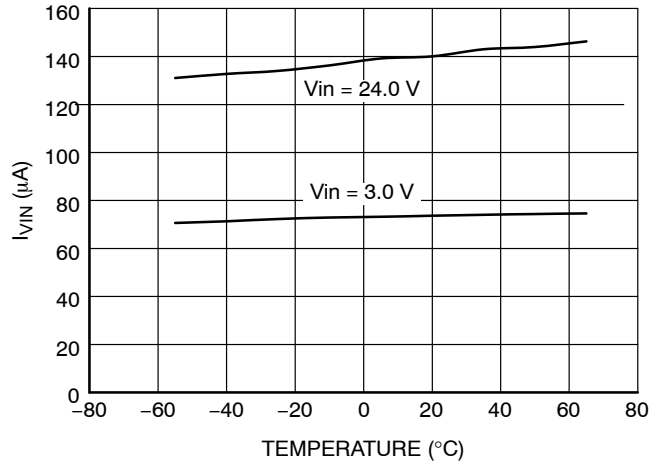

Figure 12. Vin Controller Current vs. Temperature (EN = HIGH)

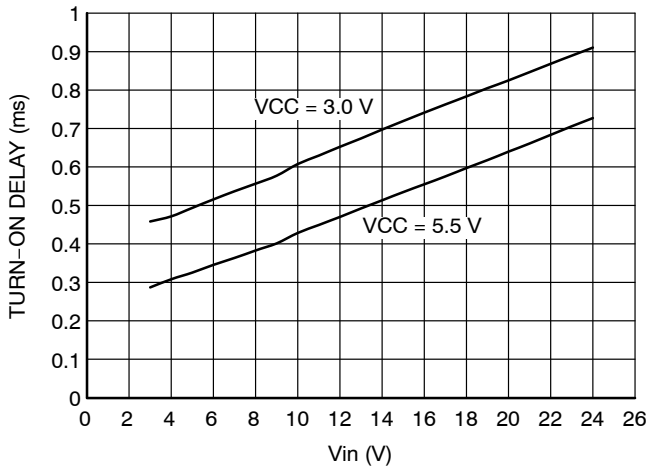

Figure 13. Output Turn-On Delay vs. Input Voltage

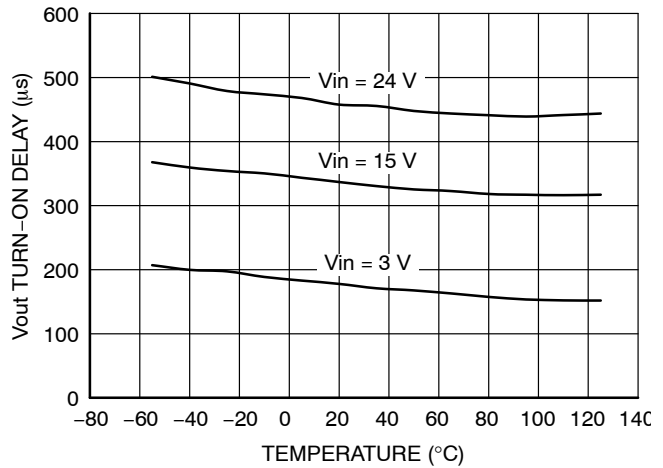

Figure 14. Output Turn-On Delay vs. Temperature

NCP45790

TYPICAL CHARACTERISTICS ($T_J = 25^\circ\text{C}$ unless otherwise specified) (continued)

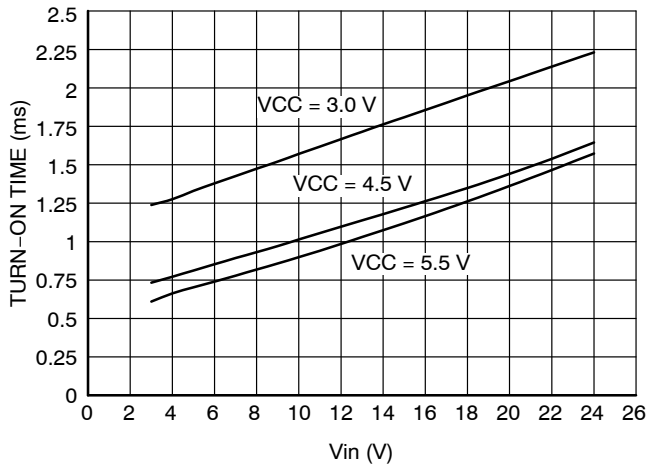

Figure 15. Power Good Turn-On Time vs. Input Voltage

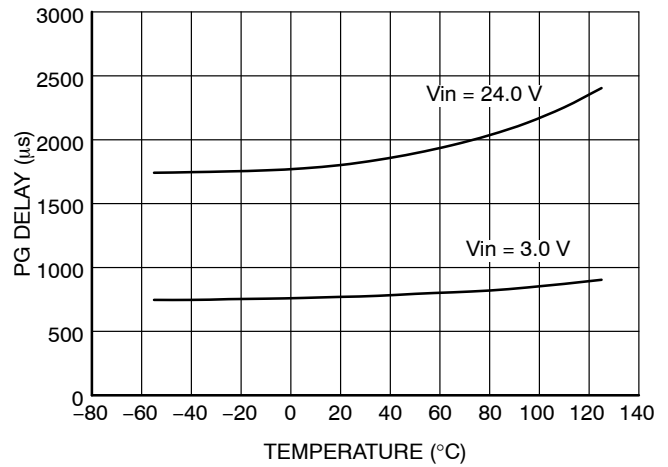

Figure 16. Power Good Turn-On vs. Temperature

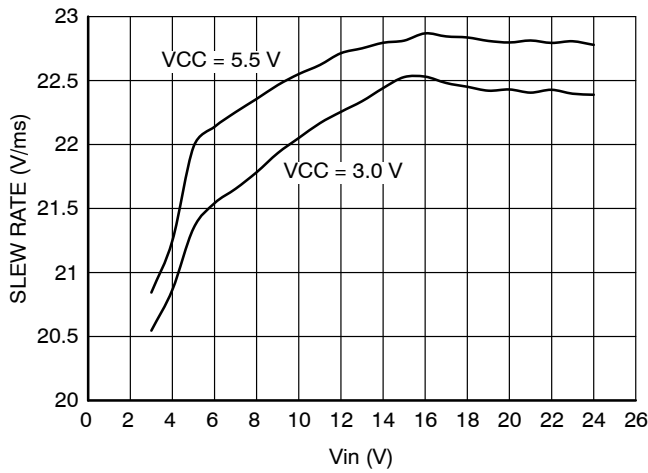

Figure 17. Default Slew Rate vs. Input Voltage (SR Pin = Floating)

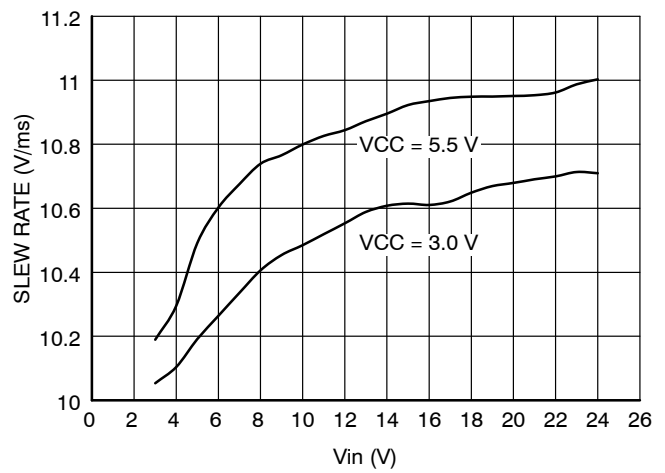

Figure 18. Slew Rate vs. Input Voltage (SR Pin = 10 nF to GND)

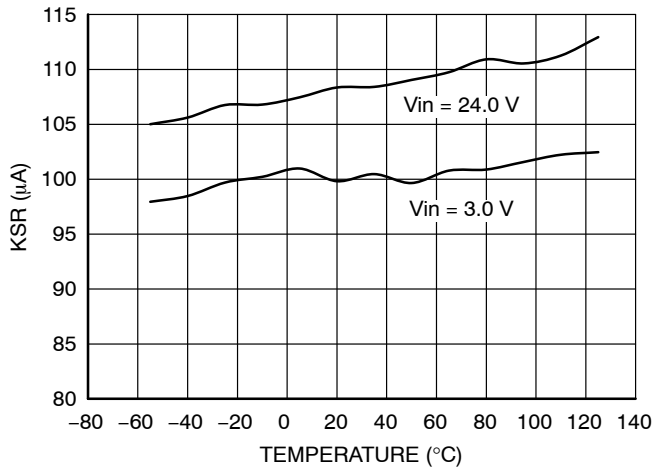

Figure 19. KSR vs. Temperature

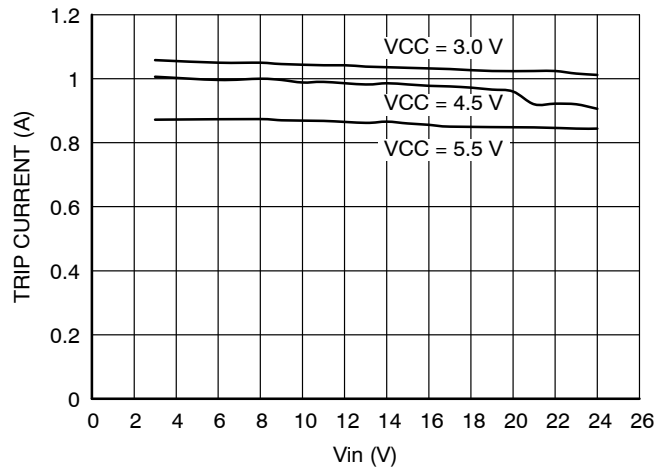

Figure 20. OCP Trip Current vs. Input Voltage (OCP = Float)

NCP45790

TYPICAL CHARACTERISTICS ($T_J = 25^\circ\text{C}$ unless otherwise specified) (continued)

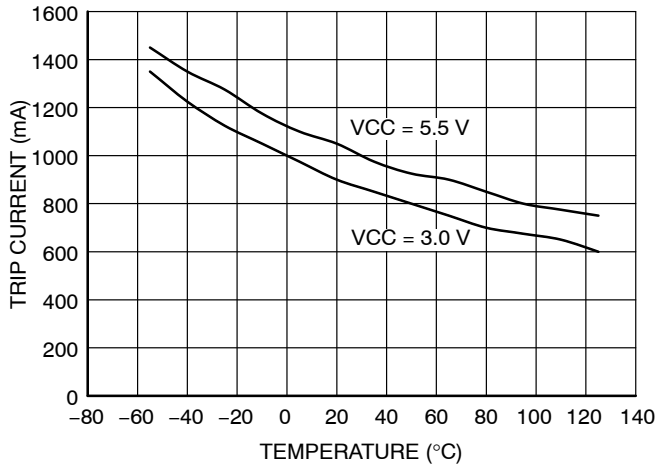

Figure 21. OCP Trip Current vs. Temperature (OCP = OPEN)

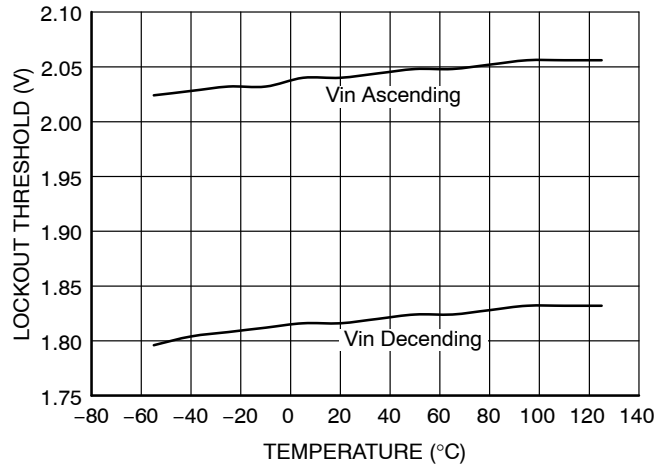

Figure 22. UVLO Trip Voltage vs. Temperature

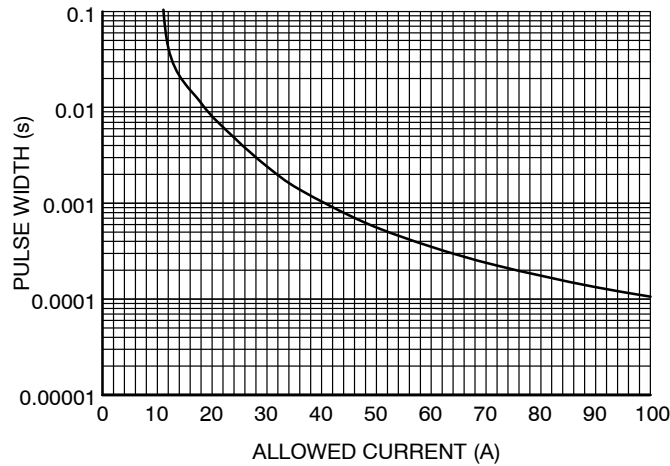

Figure 23. Safe Operating Area Transient Current

APPLICATIONS INFORMATION

Enable Control

The NCP45790 part enables the MOSFET in an active-high configuration. When the EN pin is at a logic high level and the V_{CC} supply pin has an adequate voltage applied, the MOSFET will be enabled. When the EN pin is at a logic low level, the MOSFET will be disabled. An internal pull down resistor to ground on the EN pin ensures that the MOSFET will be disabled when not driven.

Short-Circuit Protection (Hard short)

The NCP45790 device is equipped with a short-circuit protection that helps protect the part and the system from a sudden high-current event, such as the output, V_{OUT}, being hard-shorted to ground.

Once active, the circuitry monitors the voltage difference between the V_{IN} pin and the V_{OUT} pin. When the difference is equal to the short-circuit protection threshold voltage, the MOSFET is turned off. The part remains off and is latched in the Fault state until EN is toggled or V_{CC} supply voltage is cycled, at which point the MOSFET will be turned on in a controlled fashion with the normal output turn-on delay and slew rate.

Over-Current Protection (Soft short)

The NCP45790 device is equipped with an over-current protection (OCP) that helps protect the part and the system from a high current event which exceeds the expected operational current (e.g., a soft short).

In the event that the current from the V_{IN} pin to the V_{OUT} pin exceeds the OCP threshold for longer than the blanking time, the MOSFET will shut down and the PG pin is driven low. Like the short-circuit protection, the part remains latched in the Fault state until EN is toggled or V_{CC} supply voltage is cycled, at which point the MOSFET will be turned on in a controlled fashion with the normal output turn-on delay and slew rate.

The over-current trip point is determined by the resistance between the OCP pin and ground. If no over-current protection is needed, then the OCP pin should be tied to GND; if the OCP protection is disabled in this way, the short-circuit protection will still remain active.

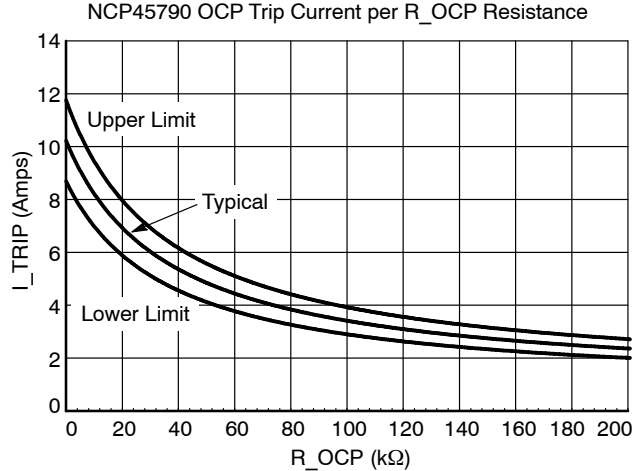

Figure 24. OCP Trip Current Setting

Thermal Shutdown

The thermal shutdown of the NCP45790 device protects the part from internally or externally generated excessive temperatures. This circuitry is disabled when EN is not active to reduce standby current. When an over-temperature condition is detected, the MOSFET is turned off.

The part comes out of thermal shutdown when the junction temperature decreases to a safe operating temperature as dictated by the thermal hysteresis. Upon exiting a thermal shutdown state, and if EN remains active, the MOSFET will be turned on in a controlled fashion with the normal output turn-on delay and slew rate.

Under Voltage Lockout

The under voltage lockout of the NCP45790 device turns the MOSFET off when the input voltage, V_{IN}, drops below the under voltage lockout threshold. This circuitry is disabled when EN is not active to reduce standby current.

If the V_{IN} voltage rises above the under voltage lockout threshold, and EN remains active, the MOSFET will be turned on in a controlled fashion with the normal output turn-on delay and slew rate.

Power Good

The NCP45790 device has a power good output (PG) that can be used to indicate when the gate of the MOSFET is fully charged. The PG pin is an active-high, open-drain output that requires an external pull up resistor, R_{PG}, greater than or equal to 100 kΩ to an external voltage source, V_{TERM}, that is compatible with input levels of all devices connected to this pin (as shown in Figures 25). The power good output can be used as the enable signal for other active-high devices in the system (as shown in Figure 25). This allows for guaranteed by design power sequencing and reduces the number of enable signals needed from the system controller. If the power good feature is not used in the application, the PG pin should be tied to GND.

NCP45790

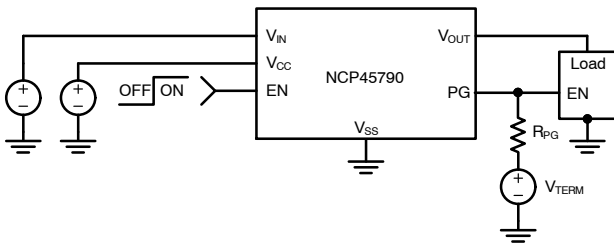

Figure 25. Guaranteed-by-Design Power Sequencing Example

Slew Rate Control

The NCP45790 device is equipped with controlled output slew rate which provides soft start functionality. This limits the inrush current caused by capacitor charging and enables these devices to be used in hot swapping applications.

The slew rate can be decreased with an external capacitor added between the SR pin and ground. With an external capacitor present, the slew rate can be determined by the following equation:

$$\text{Slew Rate} = \frac{K_{SR}}{C_{SR}} \text{ [V/s]} \quad (\text{eq. 1})$$

where K_{SR} is the specified slew rate control constant, found on page 3, and C_{SR} is the capacitor added between the SR pin and ground. Note that the slew rate of the device will always be the lower of the default slew rate and the adjusted slew rate. Therefore, if the C_{SR} is not large enough to decrease the slew rate more than the specified default value, the slew rate of the device will be the default value.

Capacitive Load

The peak in-rush current associated with the initial charging of the application load capacitance needs to stay

below the specified I_{max} . C_L (capacitive load) should be less than C_{max} as defined by the following equation:

$$C_{max} = \frac{I_{max}}{SR_{typ}} \quad (\text{eq. 2})$$

Where I_{max} is the maximum load current, and SR_{typ} is the typical default slew rate when no external load capacitor is added to the SR pin.

ecoSWITCH LAYOUT GUIDELINES

Electrical Layout Considerations

Correct physical PCB layout is important for proper low noise accurate operation of all ecoSWITCH products.

Power Planes: The ecoSWITCH is optimized for extremely low R_{on} resistance, however, improper PCB layout can substantially increase source to load series resistance by adding PCB board parasitic resistance. Solid connections to the VIN and VOUT pins of the ecoSWITCH to copper planes should be used to achieve low series resistance and good thermal dissipation. The ecoSWITCH requires ample heat dissipation for correct thermal lockout operation. The internal FET dissipates load condition dependent amounts of power in the milliseconds following the rising edge of enable, and providing good thermal conduction from the packaging to the board is critical. Direct coupling of VIN to VOUT should be avoided, as this will adversely affect slew rates. The figure below shows an example of correct power plane layout. The number and location of pins for specific ecoSWITCH products may vary. This demonstrates large planes for both VIN and VOUT, while avoiding capacitive coupling between the two planes.

MECHANICAL CASE OUTLINE PACKAGE DIMENSIONS

ON Semiconductor®

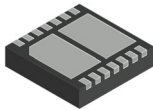

DFN14 4x4, 0.5P CASE 506EK ISSUE A

DATE 18 MAY 2021

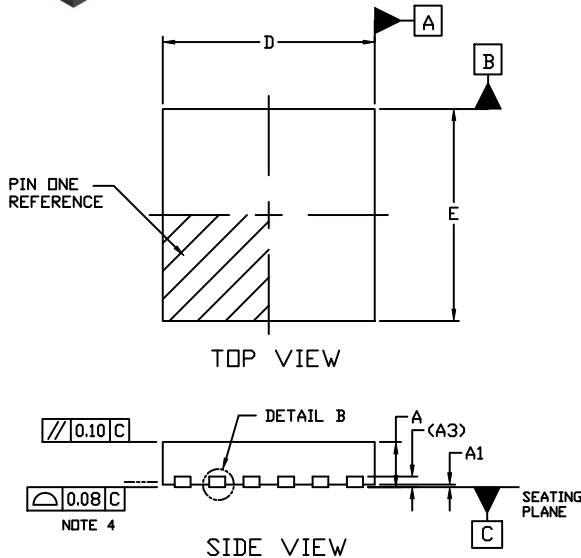

NOTES:

1. DIMENSIONING AND TOLERANCING PER ASME Y14.5M, 1994.
2. CONTROLLING DIMENSION: MILLIMETERS
3. DIMENSION b APPLIES TO PLATED TERMINAL AND IS MEASURED BETWEEN 0.15 AND 0.30MM FROM TERMINAL.
4. COPLANARITY APPLIES TO THE EXPOSED PAD AS WELL AS THE TERMINALS.

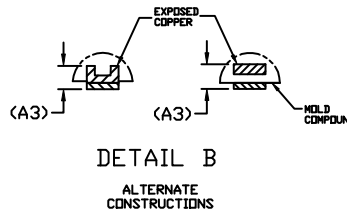

DIM	MILLIMETERS		
	MIN.	NOM.	MAX.
A	0.80	0.90	1.00
A1	0.00	—	0.05
A3	0.20 REF		
b	0.20	0.25	0.30
D	3.90	4.00	4.10
D1	0.20	0.30	0.40
D2	1.50	1.60	1.70
E	3.90	4.00	4.10
E2	2.50	2.60	2.70
e	0.50 BSC		
k	0.20	—	—
L	0.30	0.40	0.50
L1	—	—	0.15

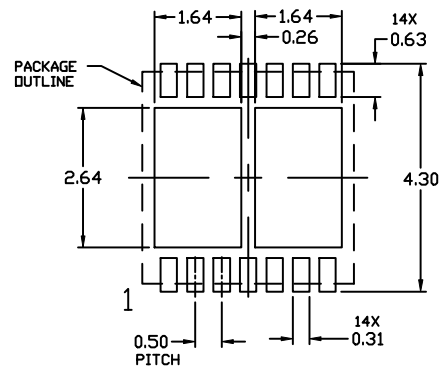
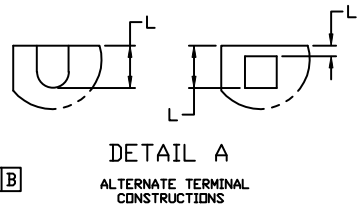
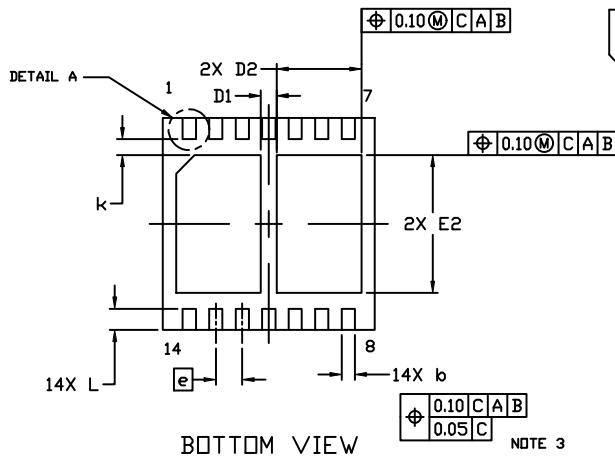

GENERIC MARKING DIAGRAM*



- XXX = Specific Device Code
- A = Assembly Location
- L = Wafer Lot
- Y = Year
- W = Work Week
- = Pb-Free Package

(Note: Microdot may be in either location)

*This information is generic. Please refer to device data sheet for actual part marking. Pb-Free indicator, "G" or microdot "▪", may or may not be present. Some products may not follow the Generic Marking.

DOCUMENT NUMBER:	98AON94406G	Electronic versions are uncontrolled except when accessed directly from the Document Repository. Printed versions are uncontrolled except when stamped "CONTROLLED COPY" in red.
DESCRIPTION:	DFN14 4x4, 0.5P	PAGE 1 OF 1

ON Semiconductor and ON are trademarks of Semiconductor Components Industries, LLC dba ON Semiconductor or its subsidiaries in the United States and/or other countries. ON Semiconductor reserves the right to make changes without further notice to any products herein. ON Semiconductor makes no warranty, representation or guarantee regarding the suitability of its products for any particular purpose, nor does ON Semiconductor assume any liability arising out of the application or use of any product or circuit, and specifically disclaims any and all liability, including without limitation special, consequential or incidental damages. ON Semiconductor does not convey any license under its patent rights nor the rights of others.

onsemi, **Onsemi**, and other names, marks, and brands are registered and/or common law trademarks of Semiconductor Components Industries, LLC dba "**onsemi**" or its affiliates and/or subsidiaries in the United States and/or other countries. **onsemi** owns the rights to a number of patents, trademarks, copyrights, trade secrets, and other intellectual property. A listing of **onsemi**'s product/patent coverage may be accessed at www.onsemi.com/site/pdf/Patent-Marking.pdf. **onsemi** reserves the right to make changes at any time to any products or information herein, without notice. The information herein is provided "as-is" and **onsemi** makes no warranty, representation or guarantee regarding the accuracy of the information, product features, availability, functionality, or suitability of its products for any particular purpose, nor does **onsemi** assume any liability arising out of the application or use of any product or circuit, and specifically disclaims any and all liability, including without limitation special, consequential or incidental damages. Buyer is responsible for its products and applications using **onsemi** products, including compliance with all laws, regulations and safety requirements or standards, regardless of any support or applications information provided by **onsemi**. "Typical" parameters which may be provided in **onsemi** data sheets and/or specifications can and do vary in different applications and actual performance may vary over time. All operating parameters, including "Typicals" must be validated for each customer application by customer's technical experts. **onsemi** does not convey any license under any of its intellectual property rights nor the rights of others. **onsemi** products are not designed, intended, or authorized for use as a critical component in life support systems or any FDA Class 3 medical devices or medical devices with a same or similar classification in a foreign jurisdiction or any devices intended for implantation in the human body. Should Buyer purchase or use **onsemi** products for any such unintended or unauthorized application, Buyer shall indemnify and hold **onsemi** and its officers, employees, subsidiaries, affiliates, and distributors harmless against all claims, costs, damages, and expenses, and reasonable attorney fees arising out of, directly or indirectly, any claim of personal injury or death associated with such unintended or unauthorized use, even if such claim alleges that **onsemi** was negligent regarding the design or manufacture of the part. **onsemi** is an Equal Opportunity/Affirmative Action Employer. This literature is subject to all applicable copyright laws and is not for resale in any manner.

ADDITIONAL INFORMATION

TECHNICAL PUBLICATIONS:

Technical Library: www.onsemi.com/design/resources/technical-documentation
onsemi Website: www.onsemi.com

ONLINE SUPPORT: www.onsemi.com/support

For additional information, please contact your local Sales Representative at www.onsemi.com/support/sales